

# AFFO

Thermal Imaging Monocular



## User Manual

AP09/AP13/AL19/AL25

V4.0

# IMPORTANT SAFETY INFORMATION

## Environmental influences

**WARNING!** Never point the lens of the device directly at intense heat sources such as the sun or laser equipment. The objective lens and eyepiece can function as a burning glass and damage the interior components. The warranty does not cover damage caused by improper operation.

## Ergonomics notes

**Caution:** Take breaks after longer periods of use to avoid wrist pain.

## Risk of swallowing

**Caution:** Do not place this device in the hands of small children. Incorrect handling can cause small parts to come loose which may be swallowed.

## Safety instructions for use

- Handle the device with care: rough handling may damage the internal battery.
- Do not expose the device to fire or high temperatures.
- Do not disassemble the device to access the battery. The battery is not

meant to be replaced by the end user.

- The battery capacity decreases when operated in a cold ambient temperature. This is not a fault and occurs for technical reasons.
- The recommended temperature for using this product is -20° to +50°. Otherwise, it will affect the service life of the product.
- Do not store the device for long periods at temperatures below -20°C or above +50°C. This permanently reduces the capacity of the battery.
- Always store the device in a dry, well-ventilated space.
- If the device has been damaged or the battery is defective, send the device to our after-sales service for repair.
- Before using this product in an environment with water, ensure that the Type-C interface rubber cap on the bottom of the thermal imaging monocular is tightly covered.

## Safety instructions for the power supply unit

- Check the power supply unit, cable and adapter for visible damage before use.
- Do not use any defective parts. Defective components must be replaced.
- Do not use the power supply unit in wet or humid environments.

- Only charge the device at temperatures ranging between 0°C and 50°C.
- Do not make any technical modifications.

### Disposal of batteries



Directive 2006/66/EC (battery directive): This product contains a battery that cannot be disposed of as unsorted municipal waste in the European Union. See the product documentation for specific battery information. The

battery is marked with this symbol, which may include lettering to indicate cadmium (Cd), lead (Pb), or mercury (Hg). For proper recycling, return the battery to your supplier or to a designated collection point. For more information see: [www.recyclethis.info](http://www.recyclethis.info).

### User information on the disposal of electrical and electronic devices (private households)



2012/19/EU (WEEE directive): Products marked with this symbol cannot be disposed of as unsorted municipal waste in the European Union. For proper recycling, return this product to your local supplier upon the purchase of equivalent new equipment, or dispose of it at designated

collection points. For more information see: [www.recyclethis.info](http://www.recyclethis.info)

### For business customers within the European Union

Please contact your dealer or supplier regarding the disposal of electrical and electronic devices. He will provide you with further information.

### Information on disposal in other countries outside of the European Union

This symbol is only applicable in the European Union. Please contact your local authority or dealer if you wish to dispose of this product and ask for a disposal option.

### Intended use

The device is intended for displaying heat signatures during nature observation, remote hunting observations and for civil use. This device is not a toy for children.

Use the device only as described in this operating manual. The manufacturer and the dealer accept no liability for damages which arise due to non-intended or incorrect use.

### Function test

- Before use, please ensure that your device has no visible damage.
- Test to see if the device displays a clear, undisturbed image.

- Check that the settings for the device are correct. See the notes in the section Operation.

### **Installing/removing the battery**

The AFFO series thermal imaging monocular is equipped with a battery. It cannot be removed.

### **Observation with and without glasses**

Thanks to the flexible eyeshade, the AFFO series can be used with or without glasses. It offers a full field of view in both cases.

# 1 Specifications

Model	AP09	AP13	AL19	AL25
<b>Detector Specifications</b>				
Type	Uncooled Vox			
Resolution	256 × 192		384 × 288	
Pixel Size, μm	12			
NETD, mk	≤ 40			
Frame Rate, Hz	25		50	
<b>Optical Specifications</b>				
Objective Lens, mm	9	13	19	25
Field of View, °	19.4×12.2	13.5×8.4	13.8×8.7	10.5×6.6
Linear Field of View(H×V), m at 100m	34.1×21.3	23.6×14.8	24.3×15.2	18.4×11.5
Magnification, ×	1.3	2.0	2.0	2.5
Digital Zoom, ×	1 / 2		1 / 2 / 4	
Diopter	-7 ~ +2			
Eye Relief, mm	20			
Exit pupil Diameter, mm	5			
Detection Range, m (Target size: 1.7m×0.5m, P(n)=99%)	460	670	980	1300
<b>Display Specifications</b>				
Type	OLED			

Resolution	640 × 400	
<b>Battery Power Supply</b>		
Battery Type / Capacity / Output Voltage	Built-in li-ion battery/3.6Ah/3.6V	
Max. Operating Time (t=22 °C), h*	9.5	7.5
External Power Supply	5V (Type C)	
<b>Physical Specifications</b>		
Ingress Protection Rating	IP67	
Memory Capacity, GB	8	
Wi-Fi / APP	Support (InfiRay outdoor)	
Operating Temperature, °C	-20 ~ +50	
Weight, g	< 340	< 350
Dimension, mm	160 × 60 × 60	169 × 60 × 60

\* Actual operation time depends on the density of Wi-Fi use and the built-in video recorder.

- Improvements may be made to the design and software of this product to enhance its features without prior notice to the customer.
- The newest user manual can be downloaded at our official website: [www.infirayoutdoor.com](http://www.infirayoutdoor.com).

## 2 Package Contents

- AFFO series thermal imaging monocular
- Neck strap
- Wrist strap
- Drawstring bag
- Type-C data cable
- Lens cleaning cloth
- Quick Start Guide

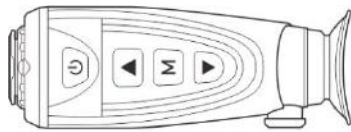

AFFO Series



Quick Start Guide



Neck Strap



Wrist Strap



USB Cable



Lens Cloth



Drawstring Bag

## 3 Description

The AFFO series thermal imaging monocular is for outdoor use. It can be used in the day or night, or in harsh weather (such as rain, snow, fog, and haze) without being affected by strong light. It requires no external light source. Even targets hidden behind obstacles (such as branches, grass, and shrubs) can be observed. The AFFO series thermal imaging monocular is light and easy to carry, small in size, suitable for single-hand operation, comfortable in use, and rich in functions. It can be widely used for hunting, searching, and locating in various outdoor conditions.

## 4 Features



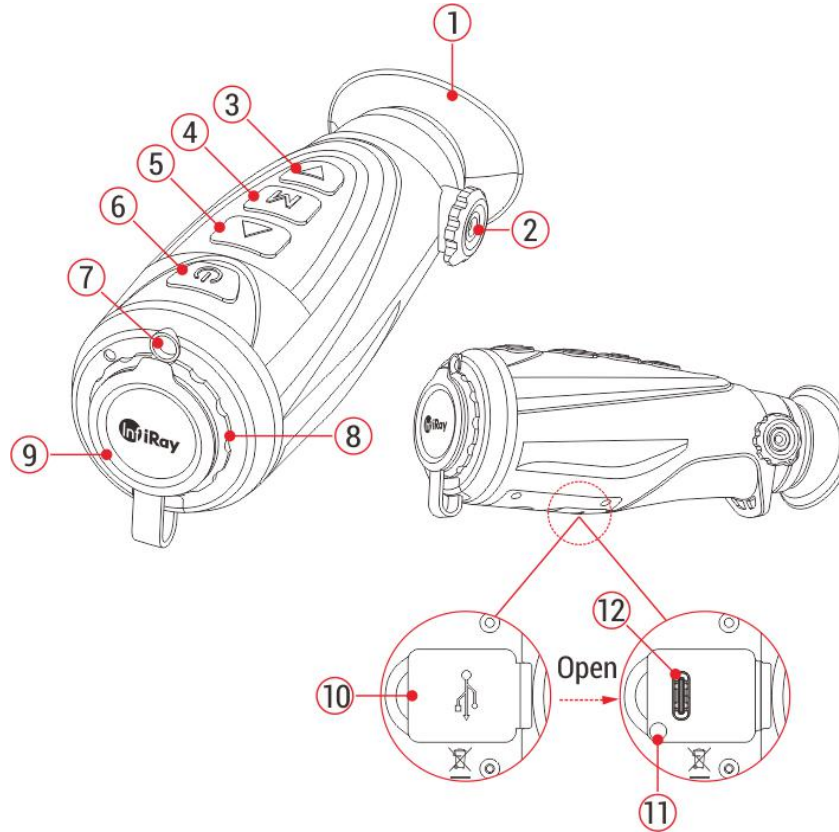

- 12 $\mu$ m self-developed detector
- High image quality
- Lightweight and compact
- Stadiametric rangefinder
- Long detection distance
- Built-in memory card, supporting photo taking and video recording
- Built-in Wi-Fi module, supporting app connection

# 5 Units and Controls

1. Eyeshade
2. Diopter adjustment
3. Down button
4. Menu (M) button
5. Up button
6. Power button
7. LED light
8. Objective lens
9. Lens cover
10. USB rubber cap
11. Power indicator
12. Type C port



## 6 Button Descriptions

Button	Current Status	Press	Press and Hold
<b>Power button</b> 	Powered off	---	Power on the device
	Home screen	Enter the standby mode (the display is off, and the main chip enters the standby mode)	Power off the device
	Standby mode	Wake up the device	---
	Menu interface	Return to the home screen without saving	Power off the device
<b>Up button</b> 	Home screen	Switch the image mode	---
	Menu interface	Scroll up the menu option	---
	Powered off	---	Keep pressing to turn on the LED indicator and release the button to turn off the LED indicator
<b>Menu button</b> 	Home screen	Digital zoom	Enter the menu interface
	Menu interface	Enter the submenu / Confirm the selection	Save and return to the home screen
<b>Down button</b> 	Home screen	Take a photo	Start the video recording
	Menu interface	Scroll down the menu option	---
	Video recording	Take a photo	Stop and save the video recording
<b>Up + M buttons</b>	Home screen	---	Turn on/off the stadiametric rangefinder function
<b>Up + Down buttons</b>	Home screen	---	Turn on/off hotspot tracking
<b>M + Down buttons</b>	Home screen	Shutter calibration	Background calibration



## 7 Charging

The AFFO series is supplied with a built-in rechargeable Li-ion battery pack, which allows operation up to 9.5 hours. **When using the device for the first time, please fully charge it first.**

- Open the USB rubber cap (10) on the bottom of the device.
- Connect the Type C plug of the data cable to the Type C port (12) on the device.
- Connect another port of the data cable to the power adapter.
- Insert the plug of the adapter to the 110-240V socket.
- When the device is charging, the power indicator (11) next to the Type C port (12) is red. The power indicator (11) is on only in the charging status. When the power indicator (11) turns green, the device is fully charged. When the power indicator (11) blinks alternately red and green, it indicates that the battery is not charged or the temperature is too high or too low.
- When charging, a lightning icon  will appear inside the battery icon on the display. The lightning icon will not disappear until the data cable is removed or the power is cut off.
- Charging is finished when the interior of the battery icon on the display

is completely green  .

- During using, when the battery icon turns red , this means the power level is low, please charge the device in time to avoid the data loss.

### Safety instructions for battery

- The rated voltage of the product is 5V. Please charge the device promptly when the battery is low so that the service life of the thermal imaging monocular will not reduce due to battery over-discharge.
- Don't charge the device instantly while bring the battery from cold environment to warm environment. Charging after 30-40 mins.
- Charge the device at a temperature from 0°C to +40°C, otherwise the battery life will be reduced significantly.
- Never use a damaged or modified charger.
- Don't leave battery unattended when charging. Don't leave the device with a charger connected to the mains longer than over 24 hours after full charge.
- Do not expose the battery to high temperature or to a naked flame.
- Don't connect external device with a current consumption that exceed permitted levels.

- The battery is short circuit protected. However, any situation that may cause short-circuiting should be avoided.
- Don't dismantle the battery from the device.
- The battery capacity may decrease when using the battery in negative temperature, that is normal, not a defect.
- Avoid using the battery at the temperature above the temperature shown in the table, this may decrease the battery's life.
- If the thermal imaging monocular is not used for a long time, recharge the device every 2 months at least and charge to 40%-50% power, then store the device in a dry and ventilated environment.
- Partial charging the battery is necessary if the battery is planned to be idled for long time. Avoid fully charged or discharged.
- Keep the battery out of the reach of children.

## 8 LED Light

The AFFO series is equipped with the LED light (7). You can quickly turn on/off the LED light (7) only when the AFFO is turned off

- When the device is powered off, keep pressing down the **Up (5)** button to turn on the LED light, and release the **Up (5)** button to turn off the LED

light.

- Please note that when the device is turned on, the LED light is unavailable.

## 9 Operation

- Open the lens cover (9).
- Press and hold the **Power (6)** button for 2s to turn on the thermal imaging monocular.
- When an infrared image is displayed in the eyepiece, the thermal imaging monocular enters the operating status.
- Rotate the diopter adjustment knob (2) to adjust the resolution of the icon on the display. The diopter adjustment knob is used to adjust the eyepiece diopter for users with different degrees of myopia.
- **Setting the image mode:** briefly press the **Up (5)** button to set the image palette mode. There are five modes for selection: white hot (☀️), black hot (☾), red hot (🔥), pseudo color (🌈) and target highlight (🐦). The icon on the top status bar is updated in real-time.
- **Setting the display brightness:** press and hold the **M (4)** button to set the display brightness level from level 1 to level 5 in the menu (refer to

the section **Menu** for details).

- **Power off:** After using the device, press and hold the **Power (6)** button for 3 seconds to enter the power-off interface with a shutdown countdown. when the countdown icon turns to 0,

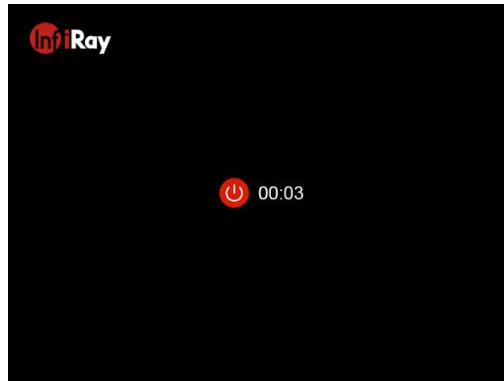

release the button. After the current status is saved, the display turns black and the device is powered off. **During the saving data, do not disconnect it from the power source, otherwise, the data cannot be saved.**

- **Standby:** On the home screen, press the **Power (6)** button briefly to standby the device. And press the **Power (6)** button again to wake up the device.

## 10 Calibration Mode

Calibration enables to equalize the detector temperature and eliminate the image defects (such as vertical bars, phantom images, etc.).

There are two calibration modes: Automatic (**A**) and Manual (**M**).

Select the required calibration mode in the Menu (referring to the **Menu - Calibration**).

- **A mode (Automatic).** When select the automatic calibration mode, it will calibrate automatically according to the software algorithm. There is no need to close the lens cover (the internal shutter covers the sensor). In this mode, manual calibration is still supported by short pressing the **M (4) + Down (3)** buttons.
- **M mode (Manual).** When select the manual calibration mode, it only calibrates the sensor by manual. Short press the **M (4) + Down (3)** buttons to activate the shutter calibration without closing the lens cover (the internal shutter covers the sensor).
- Whether in manual or automatic mode, short press the **M (4) + Down (3)** buttons to achieve the shutter calibration, and long press the **M (4) + Down (3)** buttons to achieve the background calibration.

## 11 Digital Zoom

AFFO series support to quickly increase the basic magnification by 2 times or 4 times, as well as to return to the basic magnification.

- On the home screen, briefly press the M (4) button to cyclically enable the digital zoom of 1×, 2× or 4×. The zoom status is updated in the status bar on the top in real time.

## 12 Photography and Video Recording

AFFO series is equipped with a function for video recording and photography of the observed image which is saved on the built-in 8GB memory storage.

The photo and video files are named with time, so it is suggested to reset the date and time in the Menu before using the photo and video functions (refers to **Menu - Date Setting** and **Time Settings** in this manual) or to synchronize date and time in the **InfiRay Outdoor** application.

### Photography

- On the home screen, short press the **Down (3)** button to take a photo.
- When taking a photo, the photo icon  flashes below the status bar in the upper left corner of the screen. The photo is taken successfully when the icon disappears

- If a red exclamation mark  appears after the photo icon, it indicates that the memory space is not insufficient, please clear the memory or move the footage to other storage media to free up the built-in memory space.
- Photos are stored in the built-in storage.



### Video Recording

- On the home screen, press and hold the **Down (3)** button to start the video recording function.
- Then, the recording timer in the format of the HH: MM: SS (hour: minute: second) will appear on the upper right of the display.
- During recording, it is supported to take a photo with a short press of the **Down (3)** button. Of



course, the other operations to the device are supported during recording.

- Press and hold the **Down (3)** button again to stop and save the video recording.
- All videos and photos will be saved in the build-in storage.

## Memory Access

When the device is turned on and connected to a computer, it is recognized by the computer as a flash memory card, which is used to access the device's memory and make copies of pictures and videos.

- Connect the device to a computer through the Type C data cable.
- Double click “my computer” on the computer desktop - select the USB flash disk and double click to access the memory space.
- You can select required files or folders for copying or deleting operations.

## 13 Menu Function





- On the home screen, press and hold the **M (4)** button to enter the

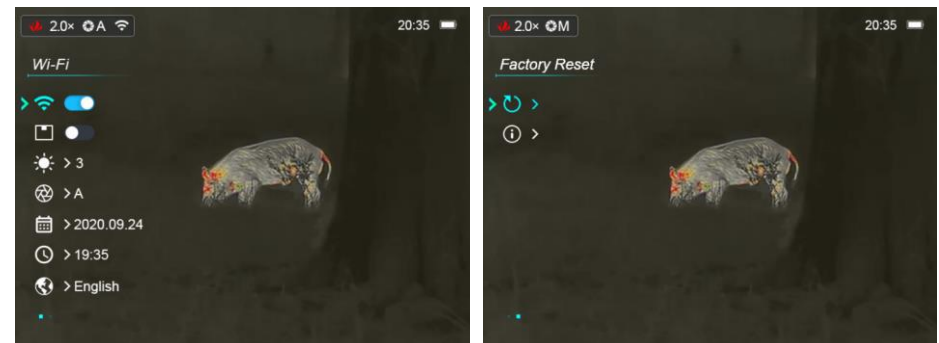

menu interface.



- Briefly press the **Up (5) / Down (3)** button to switch among the menu options.
- Menu navigation is cyclical: as soon as the last menu option of the first tab is reached, the first menu option of the second tab starts.
- Adjust the current parameters or enter the submenus with a short press of the **M (4)** button.
- In all menu interfaces, short press the **Power (6)** button return to the home screen.
- Automatic exiting from the menu to the home screen will occur after 15 seconds of inactivity.







## Menu Options and Descriptions

<p><b>Wi-Fi</b></p> 	<p><b>Turn Wi-Fi on/off</b></p> <ul style="list-style-type: none"> <li>● Press and hold down the <b>M (4)</b> button to enter the Menu interface.</li> <li>● Select the <b>Wi-Fi</b> menu option with the <b>Up (5) / Down (3)</b> button.</li> <li>● Briefly press the <b>M (4)</b> button to turn Wi-Fi on /off.</li> <li>● When the Wi-Fi function is on, the icon will appear on the status bar in the upper left corner of the screen.</li> </ul>
<p><b>PIP</b></p> 	<p><b>Turn PIP function on/off</b></p> <ul style="list-style-type: none"> <li>● Press and hold down the <b>M (4)</b> button to enter the Menu.</li> <li>● Select the <b>PIP</b> menu option with the <b>Up (5) / Down (3)</b> button.</li> <li>● Briefly press the <b>M (4)</b> button to turn PIP function on/off.</li> <li>● When the PIP function is on, a small window and a blue box will appear on the screen. The image in the separate window is the 2x magnified image that is captured by the blue box in the main image.</li> </ul>
<p><b>Display Brightness</b></p> 	<p><b>Set the display brightness level</b></p> <ul style="list-style-type: none"> <li>● Press and hold down the <b>M (4)</b> button to enter the Menu.</li> <li>● Select the <b>Display Brightness</b> menu option with the <b>Up (5) / Down (3)</b> button.</li> <li>● Briefly press the <b>M (4)</b> button to enter the submenu.</li> <li>● There are five levels for selection. Select one level with the <b>Up (5) / Down (3)</b> button.</li> <li>● Briefly press the <b>M (4)</b> button to confirm your selection and return to the menu interface.</li> </ul> 

	<ul style="list-style-type: none"> <li>● The default level is 3.</li> </ul>
<p><b>Calibration</b></p> 	<p><b>Select calibration mode</b></p> <p>There are two calibration modes: Automatic(A) and Manual (M). The selected calibration mode is displayed in the status bar.</p> <ul style="list-style-type: none"> <li>● Press and hold down the <b>M (4)</b> button to enter the Menu.</li> <li>● Select the Calibration menu option with the <b>Up (5) / Down (3)</b> button.</li> <li>● Briefly press of the <b>M (4)</b> button to enter the submenu.</li> <li>● Press <b>Up (5) / Down (3)</b> button to select one mode from the following modes:             <ul style="list-style-type: none"> <li>- <b>Automatic (A)</b>. The software determines the need for calibration in automatic mode. The calibration process starts automatically.</li> <li>- <b>Manual (M)</b>. The user independently determines the need for calibration based on the quality of the observed image.</li> </ul> </li> <li>● Briefly press <b>M (4)</b> button to confirm your selection and return to the menu interface.</li> <li>● Whether in manual or automatic mode, shutter correction can be achieved with a short press of <b>M (4) + Down (3)</b> buttons, and background correction can be achieved with a long press of <b>M (4) + Down (3)</b> buttons.</li> <li>● The icon of the calibration mode will be displayed on the status bar.</li> </ul>
<p><b>Date</b></p> 	<p><b>Set the date of the device</b></p> <ul style="list-style-type: none"> <li>● Press and hold down the <b>M (4)</b> button to enter the Menu.</li> <li>● Select the <b>Date Setting</b> menu option with the <b>Up (5) / Down (3)</b> button.</li> <li>● Briefly press the <b>M (4)</b> button to active the <b>Date</b> submenu. Two triangle icons will appear above and below the value.</li> <li>● Date format is displayed as <b>YY.MM.DD</b> format (2020.01.01).</li> <li>● Select the correct value for the year, month and day with a short press of the <b>Up (5) /</b></li> </ul> 

	<p><b>Down (3)</b> button.</p> <ul style="list-style-type: none"> <li>● Switch between digits with a short press of the <b>M (4)</b> button.</li> <li>● Save selected date and exit the submenu with a long press of the <b>M (4)</b> button.</li> <li>● Or, briefly press the <b>Power (6)</b> button to return to the home screen without saving.</li> </ul>
<p><b>Time</b></p> 	<p><b>Set the time of the device</b></p> <ul style="list-style-type: none"> <li>● Press and hold down the <b>M (4)</b> button to enter the Menu.</li> <li>● Select the <b>Time Setting</b> menu option with the <b>Up (5) / Down (3)</b> button.</li> <li>● Briefly press the <b>M (4)</b> button to active the <b>Time</b> submenu. Two triangle icons will appear above and below the value.</li> <li>● Time format is displayed as <b>HH:MM</b> in 24-hours format (14:48).</li> <li>● Select the correct value for the hour and minute with a short press of the <b>Up (5) / Down (3)</b> button.</li> <li>● Switch between digits with a short press of the <b>M (4)</b> button.</li> <li>● Save the selected time and exit the submenu with a long press of the <b>M (4)</b> button.</li> <li>● Or, briefly press the <b>Power (6)</b> button to return to the home screen without saving.</li> </ul> 
<p><b>Language</b></p> 	<p><b>Set the GUI Language</b></p> <ul style="list-style-type: none"> <li>● Press and hold down the <b>M (4)</b> button to enter the Menu.</li> <li>● Select the <b>Language</b> menu option with the <b>Up (5) / Down (3)</b> button.</li> <li>● Briefly press the <b>M (4)</b> button to enter the submenu of the language.</li> </ul>



	<ul style="list-style-type: none"> <li>● Select the desired language with a short press of the <b>Up (5) / Down (3)</b> button. AFFO series support English and Chinese two languages.</li> <li>● Confirm your selection with a short press of the <b>M (4)</b> button and return to the menu interface automatically.</li> </ul>	
<p><b>Factory Reset</b></p> 	<p><b>Reset to Factory Settings</b></p> <ul style="list-style-type: none"> <li>● Press and hold down the <b>M (4)</b> button to enter the Menu on the home screen.</li> <li>● Select the <b>Factory Reset</b> menu option with the <b>Up (5) / Down (3)</b> button.</li> <li>● Enter the <b>Factory Reset</b> submenu with a short press of the <b>M (4)</b> button.</li> <li>● Briefly press the <b>Up (5) / Down (3)</b> button to select <b>Yes</b> or <b>No</b>.</li> <li>● Confirm your selection with a short press of the <b>M (4)</b> button.</li> <li>● If <b>Yes</b> is selected, the device will complete the factory reset.</li> <li>● If <b>No</b> is selected, the action will be cancelled and will return to the menu interface.</li> </ul>	
<p><b>Info</b></p> 	<p><b>Show device information</b></p> <ul style="list-style-type: none"> <li>● Press and hold down the <b>M (4)</b> button to enter the Menu on the home screen.</li> <li>● Select the <b>Info</b> menu option with the <b>Up (5) / Down (3)</b> button.</li> <li>● The relevant information of the device will be shown by a short press of the <b>M (4)</b> button.</li> <li>● This item allows the user to view the following information: the product model, SN</li> </ul>	

number, PN number, hardware version, software version and the core version.

- Press the **Power (6)** button briefly to return to the home screen.

## 14 Stadiametric Rangefinder

AFFO series support the stadiametric rangefinder function, which allows user to estimate the approximate distance to an object with a known size.

- On the home screen, press and hold the **Up (5) + M (4)** buttons simultaneously to enter the stadiametric rangefinder mode.
- When this function is on, two horizontal lines for measurement will appear on the display, meanwhile icons of three predefined objects and measured values will be displayed on the right side.
- Three pre-defined target values are provided as follows:
  - Deer: 1.7m high
  - Wild boar: 0.9m high
  - Hare: 0.2m high
- Locate the object in the middle of the measurement lines.



- Widen or lessen the measurement line to ensure that the measured object is within the line with short or long press of the **Up (5) / Down (3)** button.
- When you adjust the width of the measurement line, the rangefinder data on the right changes accordingly.
- Press and hold the **Up (5) + M (4)** buttons again to exit the stadiametric rangefinder function.

## 15 Hotspot Tracking

The AFFO series provides hotspot tracking function, which allows you to track the hottest object in the image.

- On the home screen, press and hold the **Up (5) + Down**



**(3)** buttons to turn on the hotspot tracking function.

- A blue box will appear in the image and track the hottest object automatically.
- Press and hold the **Up (5) + Down (3)** buttons again to exit the hotspot tracking function.

## 16 PIP Function

The PIP (Picture in Picture) function allows you to see both a magnified image in a particular window and the main image. This window shows part of the image which is enlarged to 2x in a certain area of the main image.

- On the home screen, press and hold the **M (4) button** to enter the menu interface.
- Select the PIP option with the **Up (5) / Down (3)** button.
- Turn the PIP function on with a short press of the **M (4)** button.
- When the PIP function is on, a small window and a blue box will appear on the



screen. The image in the separate window is the 2x magnified image that is captured by the blue box in the main image, when the laser indicator is turned on, zoom in with the laser cursor as the center.

- When the main image is enlarged with a short press of the **M (4) button**, the PIP image will synchronously be enlarged two times.
- For example, when the magnification of the main image is 1x, 2x, 4x, the corresponding magnification of the PIP image is 2x, 4x, 8x.

## 17 Wi-Fi

The AFFO series has built-in Wi-Fi module for wireless communication with mobile devices (smartphone or tablet) via Wi-Fi.

- Press and hold down the **M (4) button** to enter the Menu.
- Select the Wi-Fi menu option with the **Up (5) / Down (3)** button.
- Turn Wi-Fi function on /off with a short press of **M (4)** button.
- After the Wi-Fi of the device is enabled, search for the Wi-Fi signal with the name such as AP13\_XXXXXX on the mobile device, among which XXXXXX is a 6-bit serial number composed of digits and letters.
- Select this Wi-Fi, enter the password on the mobile to set up the connection. The initial password is 12345678.

- After Wi-Fi is successfully connected, you can control the device via the mobile app.
- Launch **InfiRay Outdoor** application on your mobile device (refer to the section **Update and InfiRay Outdoor**).

### Setting Wi-Fi name and password

The Wi-Fi name and password of AFFO series can be reset in the **InfiRay Outdoor** application.

- After connected to the mobile device, find and click the "Setting" icon  in the **InfiRay Outdoor** image screen to enter the setting interface.
- In the text box, enter and submit the new Wi-Fi name (SSID) and password.
- After submitting the change, reboot the device take the new name and password effect.



#### Note

- When factory Settings are restored, the Wi-Fi name and password are also restored to factory default settings.

## 18 Updates and InfiRay Outdoor

The AFFO series thermal imager supports **InfiRay Outdoor** technology, which allows you to transmit the image from the thermal imager to the smartphone or tablet via Wi-Fi in real time mode.

You can find detailed instructions about **InfiRay Outdoor** at the official website [www.infirayoutdoor.com](http://www.infirayoutdoor.com).

The design of the AFFO series provides the software update option. Updating is possible via the **InfiRay Outdoor** application. Also, it is feasible to download and update software from the official website: [www.infirayoutdoor.com](http://www.infirayoutdoor.com).

### About InfiRay Outdoor

- You can get **InfiRay Outdoor** application in the official website, or search **InfiRay Outdoor** in App store or scan the following QR code to download.



- When installation is completed, open it.
- If your device has been connected to a mobile device, please switch on

the mobile data in mobile device. After the device accesses the Internet, an update prompt will be displayed automatically. Click **Now** to download the latest version immediately or click **Later** to update later.

- **InfiRay Outdoor** saves the last connected device automatically. Therefore, once you link to InfiRay Outdoor before, it will automatically detect an update in the background even when the device is not connected to a phone or laptop. If an update is available and the mobile device accesses the internet, you can download the update first. Then, when the device is connected to the mobile device, the version will be updated automatically.
- After the update is installed, the device will root.

## 19 Technical Inspection

It is recommended to carry out a technical inspection each time before using the monocular. Check the following:

- The appearance (there should be no cracks on the body).
- The condition of the object lens and eyepiece (there should be no cracks, greasy spots, dirt or other deposits).
- The battery status (it should be charged).

- The controls/buttons should be in working order.

## 20 Legal and Regulatory Information

Wireless transmitter module frequency range:

**WLAN: 2.412-2.472GHz (For EU)**

Wireless transmitter module power < 20dBm (only for EU)

 We hereby declare that the radio equipment AFFO series is in compliance with the Directives 2014/53/EU and 2011/65/EU.

### FCC Statement

**FCC ID: 2AYGT-2J-00**

### Labeling requirements

This device complies with part 15 of the FCC Rules. Operation is subject to the following two conditions: (1) This device may not cause harmful interference, and (2) this device must accept any interference received, including interference that may cause undesired operation.

### Information to the user

Any Changes or modifications not expressly approved by the party responsible for compliance could void the user's authority to operate the equipment.

### EMC: Class A

**Note:** This equipment has been tested and found to comply with the limits for a Class A digital device, pursuant to part 15 of the FCC Rules. These limits are designed to provide reasonable protection against harmful interference when the equipment is operated in a commercial environment. This equipment generates, uses, and can radiate radio frequency energy and, if not installed and used in accordance with the instruction manual, may cause harmful interference to radio communications. Operation of this equipment in a residential area is likely to cause harmful interference in which case the user will be required to correct the interference at his own expense.

To comply with RF exposure requirements, a minimum separation distance of 0.00 cm must be maintained between the user's body and the handset, including the antenna.

### Power adapter manufacturer

Shenzhen Simsukian Electronics Technology Co., Ltd.

Add: Simsukian Industrial Park, Jiayi Industrial Zone, Guihua Village, Guanlan Street, Longhua District, Shenzhen, P.R. China

Model No.: SK22G-0500200Z

Input: 100-240V~50/60Hz, MAX/0.35A

Output: 5.0V $\overline{\text{---}}$  2.0A 10.0W