



**Operating Manual**

**V1.0**

**Clip CH50W** | **Thermal Imaging Attachment**

**CH50W**



**IRay Technology Co., Ltd.**

Add: 11th Guiyang Street, YEDA, Yantai, P.R. China

Tel: 0086-400-998-3088

Email: [infrayoutdoor@infray.com](mailto:infrayoutdoor@infray.com)

Web: [www.infrayoutdoor.com](http://www.infrayoutdoor.com)

Infiray Outdoor • Clip CH50W • Operating Manual [www.infrayoutdoor.com](http://www.infrayoutdoor.com)

# IMPORTANT SAFETY INFORMATION

## Environmental influences

**Note:** Never point the lens of the device directly at intense heat sources such as the sun or laser equipment. The objective lens and eyepiece can function as a burning glass and damage the interior components.

## Risk of swallowing

**Caution:** Do not place this device in the hands of small children. Incorrect handling can cause small parts to come loose which may be swallowed.

## Safety instructions for use

- Do not expose the device to fire or high temperatures.
- The battery capacity decreases when operated in a cold ambient temperature. This is not a fault and occurs for technical reasons.
- Always store the device in its carrying bag in a dry, well-ventilated space. For prolonged storage, remove the batteries.
- Do not expose your device to extreme temperatures lower than - 20°C and higher than + 50°C.
- The product shall only be connected to a USB Type C interface.
- If the device has been damaged or the battery is defective, send the device to our after-sales service for repair.

## User information on the disposal of electrical and electronic devices (private households)



The WEEE symbol on products and/or accompanying documents indicates that used electrical and electronic products must not be mixed with ordinary household waste. For proper treatment, recovery and recycling, take these products to the appropriate collection points where they will be accepted without charge. In some countries, it may also be possible to return these products to your local retailer when you purchase a corresponding new product. The proper disposal of this product serves to protect the environment and prevents possible harmful effects on human beings and their surroundings, which may arise as a result of incorrect handling of waste. More detailed information on your nearest collection point is available from your local authority. In accordance with state legislation, penalties may be imposed for the improper disposal of this type of waste.

## For business customers within the European Union

Please contact your dealer or supplier regarding the disposal of electrical and electronic devices. He will provide you with further information.

### **Information on disposal in other countries outside of the European Union**

This symbol is only applicable in the European Union. Please contact your local authority or dealer if you wish to dispose of this product and ask for a disposal option.

### **Intended use**

The device is intended for displaying heat signatures during nature observation, remote hunting observations and for civil use. This device is not a toy for children.

Use the device only as described in this instruction manual. The manufacturer and the dealer accept no liability for damages which arise due to non-intended or incorrect use.

### **Function test**

- Before use, please ensure that your device has no visible damage.
- Test to see if the device displays a clear, undisturbed image.
- Check that the settings for the thermal imaging camera are correct. See the notes in the section Operation.

### **Installing/removing the battery**

The Clip C series needs to install two CR123 batteries for use. Refer to the section Battery Installation for details. Also, two 16650 batteries can be used with the InfiRay's extra battery accessory.

# 1 Specifications

Model	CH50W
<b>Detector Parameters</b>	
Detector Type	VOx Uncooled
Resolution	640*512
Pixel Size	12um
NETD	≤40mk
Frame Rate	50Hz
<b>Optics Parameters</b>	
Objective Lens	50mm
Field of View	8.8°×7.0°
Recommended magnification of the day sight, x	G1/G2: 1x-4x G3/G4: 5x-9x
E-zoom	x1/x2/x4
Detection Range (Target size: 1.7m×0.5m, P(n)=99%)	2597m
<b>Display Parameters</b>	
Type	OLED
Resolution	1024×768

<b>Electrical Parameters</b>	
Battery	CR123×2/16650x2
Max. Battery Life	4h/7h
<b>External Interface</b>	
USB Interface	Type-C
Video Output	PAL (RCA Port)
<b>Physic Parameters</b>	
IP Rating	IP66
Remote Control	Bluetooth
Amount of built-in memory	32 GB
InfiRay Outdoor APP	Support
Weight (without batteries)	<590g
Dimension	175mm×74mm×68mm
Adapter Ring	M52×0.75

- \* The actual operating time depends on the intensity of using Wi-Fi, video recorder, laser rangefinder.
- Improvements may be made to the design and software of this product to enhance its useful features. Technical parameters of the device may be improved without prior notice of the customer.

## 2 Description

Clip CH50W is a front attachment designed as the infrared expansion device of the day-light sight. Different from the night vision device based on image enhancement, Clip CH50W doesn't need external light source and isn't influenced by strong light exposure. It can be used in the night or bad weather conditions such as fog, rain, smog and can detect the objects through obstacles such as branch, tall grass, dense bushes and so on. Clip CH50W has a wide range application including night hunting, observation and terrain orientation, search and rescue operations.

Using the Clip Series Front Attachment includes several benefits over night hunting with traditional optics or even the night vision devices. Attaching the Clip Series to a traditional scope delivers the same creature comforts of shooting with day optics you are accustomed to, including your existing reticle and eye relief. The Clip Series Front Attachment even allows you to continue utilizing your riflescope's variable magnification.

## 3 Components and Controls











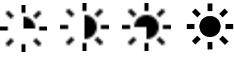



1. Lens cover
2. Lens focus knob
3. Objective lens
4. Power (P) button
5. Menu (M) button
6. Camera (C) button
7. Battery compartment cover
8. Type-C port
9. Attachment's eyepiece
10. Bayonet-type ring of attachment's eyepiece
11. Eyeshade for monocular

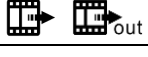



## 4 Features

- 12μm thermal imaging detector
- Detection range beyond 2.5km
- 1024×768 high resolution AMOLED display
- No rezeroing required and quick attached
- Familiar precision
- Capture/Video recording
- Support APP connecting via Wi-fi
- Bluetooth remote control
- Four image modes – white hot, black hot, red hot, pseudo color
- Monocular digital zoom: ×1, ×2, ×4
- Recommended magnification of the day sight: ×1-×9

## 5 Icons Instructions

	Screen brightness 
	Image mode: B (Black hot)、W (White hot)、R (Red hot)、C (Pseudo Color)
	E-zoom (Only for Monocular:×1, ×2, ×4)
	Ultraclear mode
	Wi-Fi
	Bluetooth
	Bluetooth connected
	Video output
	Handheld mode
	Auto shutter calibration
	Battery type
	Reticle type, four customize sorts
	Image calibration
	Time and Date setting
	Blind pixel correction
	Factory reset

	Battery capacity indicator
	Type C connection
	Orientation shift

## 6 Battery Installation

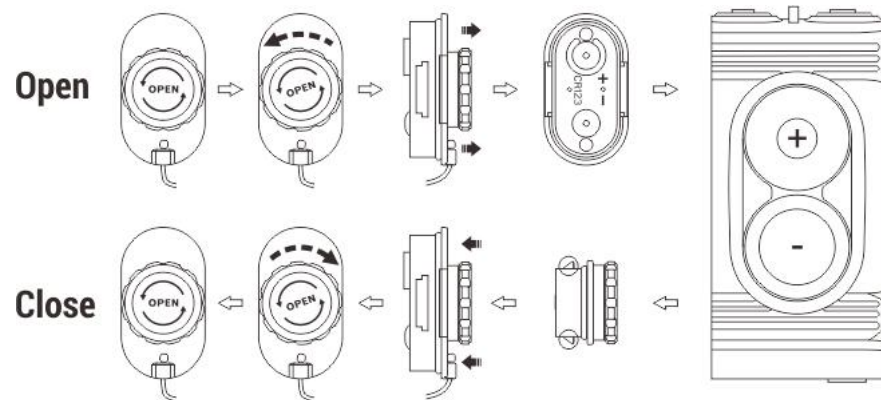

- Rotate the battery compartment cover **(7)** anticlockwise according to the prompt identification on the cover.
- Install the two CR123 batteries correctly according to the marking on the battery cover and inside it.
- When done, replace the battery cover - the latches from both sides of

the cover will pull out (see the drawing above), press it until its clicking position - make sure the cover is closed on both sides correctly.

- Battery level is displayed on the status bar (  ).
- When the battery icon turns red, please replace the new battery in time.
- It is necessary to power off before replacing the batteries.

### Attention

- **Disposable batteries are ONLY suggested!** Risks are existing to use rechargeable batteries due to nonstandard quality.
- Please do not use batteries of different types or batteries with various charge levels.
- After installation, please set the battery type in the main menu for the first starting up - choosing 3.7V for rechargeable battery and 3V for ordinary battery (referring to the section **Main Menu- Battery Type**), otherwise the battery level indication will be inaccurate and may be interrupted during operation.
- The Clip C series also supports the extended use of 16650 batteries with the InfiRay's extra battery accessory **(12)**, to increase the working

time of the product up to 7 hours.

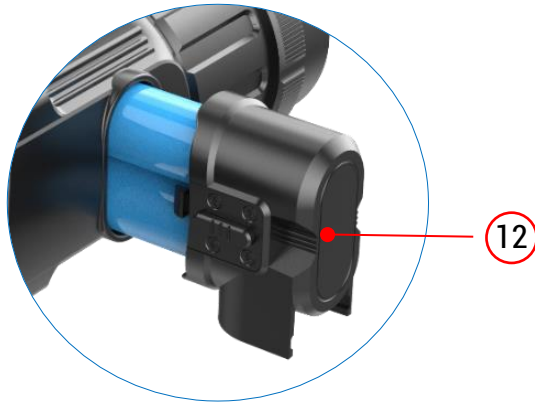

### Safety Regulation

- Please use standard batteries. Do not throw the batteries away or put them into fire after usage.
- Please use standard charger to prevent the product from damage.
- Short circuit products are prohibited.
- It is prohibited to expose the product in the high temperature environment more than 60°C.
- It is prohibited to put the product into fire.

## 7 Description of Controls

Button	Status / Current Operation Mode	Short Press	Long Press
<b>P button</b> 	Home screen interface	Standby/ Waken	Power on / Power off
	Menu interface	Adjust parameter /Scroll up options	---
	Image calibration interface	Move one pixel to the up/right	Move quickly to the up/right
	stadiametric rangefinder interface	Increase the distance between the measurement lines	Quickly increase
<b>M button</b>	Home screen interface	Enter the shortcut menu	Enter the main menu



M	Menu interface	Function switch/Parameter selection	Save and exit menu
	Image calibration interface	Switch the movement direction	Save and exit
	Stadiametric rangefinder interface	——	Exit stadiametric rangefinder function
<b>C button</b> 	Home screen interface	Take a picture	Start recording a video
	Menu interface	Adjust parameter/Scroll down options	——
	Image calibration interface	Move one pixel to the down/left	Move quickly to the down/left
	Stadiametric rangefinder interface	Reduce the distance between measurement lines	Quickly reduce
<b>M + C button</b>	Home screen interface	Shutter correction	Background correction
<b>P + M button</b>	Home screen interface	— —	<b>Monocular:</b> Turn the stadiametric rangefinder function on/off

## 8 Installation

Clip CH50W can be used as a monocular or front attachment for day device.

Original design allows the attachment to be quickly converted into monocular and vice versa. The factory default is as a front attachment.

### As a front attachment

Clip series as an attachment is designed to use a day device both in the nighttime and daytime in inclement weather (fog, smog, rain etc.).

To mount it on a day device, please follow instructions as follows:

- Measure the outer diameter of the housing of the lens of your day device.
- Select an adapter ring with the internal thread M52\*0.75 (bought separately) of the required diameter depending on the outer diameter of

your day device.

- Install firmly the adapter onto the objective lens of your day device.
- Mount the Clip CH50W with attachment's eyepiece onto the adapter by the thread M52\*0.75.
- After adjusting Clip to the appropriate position, turn the bayonet ring of attachment's eyepiece **(10)** counterclockwise to lock the eyepiece.
- When use as a front attachment, please ensure that the Handheld Mode is off in the Main Menu interface.

### As a monocular

- Remove the CH50W from the day device.
- Install the eyeshade provided in the package on the eyepiece of the CH50W by thread locking.
- Then press and hold down the **M (5)** button to enter the main menu interface.
- Select the **Handheld mode** option with the **P (4) / C (6)** button.
- Turn the Handheld mode on with a short press of the **M (5)** button.
- Then you can use the CH50W as a monocular.
- When use as a monocular, the function about zeroing will be unable,

such as the image calibration and zeroing type.

- To switch to the attachment, just take off the eyeshade and turn the Handheld mode off.

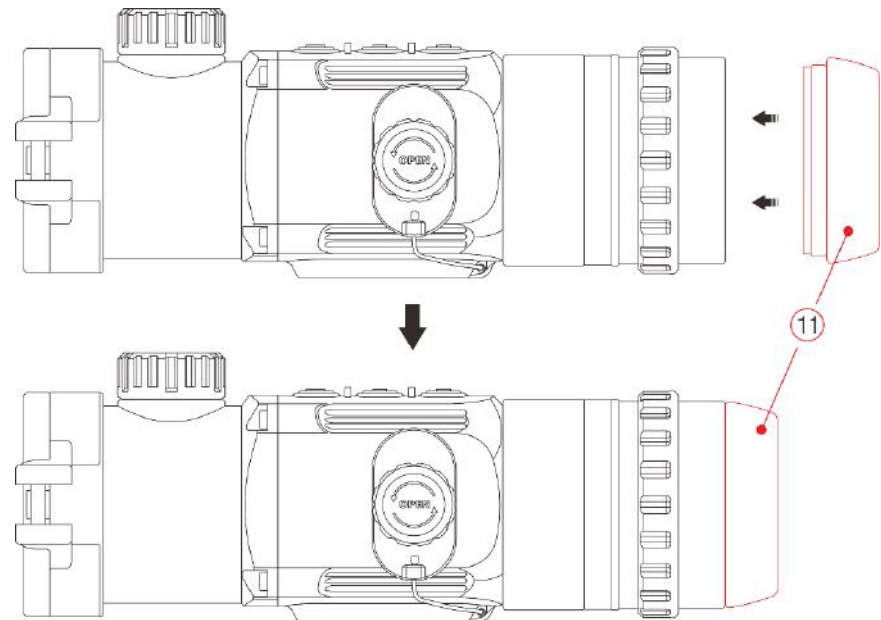

## 9 Operation

- Open the lens cover **(1)**.
- Press and hold down the **P (4)** button for 3s to power the device on.  
Wait for 6s until thermal image appears on the display.
- **Lens Focus Adjustment:** rotate the lens focus ring **(2)** to focus on the object being observed.
- **Calibration:**
  - **Shutter Calibration:** calibrate the image with a short press of the **M (5) + C (6)** buttons for shutter calibration.
  - **Background Calibration:** long press the **M (5) + C (6)** buttons until the display appears the prompt of “close the lens cap”, then close the lens cover **(1)** to complete the background calibration.
- **Image Settings:** adjust the image mode, display brightness, in the shortcut menu (for more details, see the **Shortcut Menu Functions** section)
- **Power Off:** To power off the riflescope, long press the **P (4)** button for 5s to shut down.
- **Standby Mode:** During use, pressing the **P (4)** button briefly can make

the device to enter the standby mode for power saving. And press the **P (4)** button again to wake up your device.

## 10 Image Calibration (Only for Attachment)

When the device is installed on the day light scope as an infrared extension component, if the reticle of the day light scope is not in the center of the infrared image that the image calibration function can be used to shift the infrared image to ensure the position consistency between the day light image and the infrared image.

- Please finish the calibration of the day light scope before mounting Clip CH50W.
- Install Clip CH50W on the day light sight and repeat the calibration steps above. Then aiming at the target at 100 meters and shoot.
- Measure the horizontal distance and vertical distance between the bullet hitting point and the aiming point afterwards.
- In the home screen, press and hold down **M (5)** button to enter the main menu.
- Select and set a zeroing type (refer to **Main Menu - Zeroing type** for

details)

- Select the **More** option with the **P (4) / C (6)** button and enter the submenu with a short press of the **M (5)** button.
- Then, select the Image calibration option with the **P (4) / C (6)** button and enter the image calibration interface with a short press of the **M (5)** button.
- In the image calibration interface, according to the measured value, move the position of infrared image with a short or long press the **P (4) / C (6)** button.
- Press the **M (5)** button briefly to switch the movement direction (right - left or up - down) while the moving distance is displayed synchronously above the icon.
- When the movement is done, long press the **M (5)** button to save and exit the image calibration function, or hold down **P (4) + C (6)** buttons for 3s to save the calibration position and set the coordinate as (0,0).

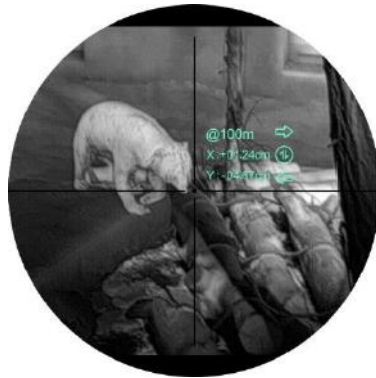

of

## 11 Stadiametric Rangefinder (Only for Monocular)

Stadiametric rangefinder is only for monocular mode that can estimate approximate distance to an object of known size.

- In the home screen, press and hold the **P (4) + M (5)** buttons for 3s at the same time to enter the stadiametric rangefinder interface.
- You will see the following on the display: two T-type measurement lines, icons of three reference objects and respective distances of each.
- There are three pre-set reference objects:
  - **Hare** - height 0.2m
  - **Wild boar** - height 0.9m
  - **Deer** - height 1.7m
- Aiming at the target, and then adjust the distance between the measurement lines by pressing **P (4) / C (6)** button until the target matches entirely between the two bars. **P (4)** button is used to increase the distance and **C (6)** button to reduce the distance. Long



pressing can increase or reduce quickly.

- The distance to the object is automatically recalculated while moving the measurement lines and displayed on the left of the three reference objects.
- Exit rangefinder mode with a long press of the **M (5)** button.

## 12 Take Photos and Video Recording

The CH50W is built-in storage space for photo taking and video recording. The files of images and videos will be named by time, so it is recommended to set the time in the main menu or synchronize the time in the Settings of the APP before using the function of photographing and recording. For specific operations, you can download the operation instructions of the APP from the company website.

### Take Photos

- Press the **C (6)** button to take a photo in the home screen.
- A camera icon shows in the center of the screen and the image will

freeze for 0.5s when the function performs.

- Photographs are saved in the built-in storage space.

### Video recording

- Press and hold down the **C (6)** button in the home screen to start the video recording.
- A tooltip showing the recording time in the format of HH: MM: SS (hour: minute: second) will appear in the upper center of the display.
- During the recording process, press the **C (6)** button to take a picture.
- Press and hold down the **C (6)** button again to stop and save the recording.
- The video and photo are saved in the built-in storage space.
- The photos and videos can be read on the computer via the USB cable.



## Note

- Note that the recorded video cannot be saved if you directly shut down or power off the device other than long pressing the **C (6)** button to exit
- You can enter and work on the menu during video recording.
- The maximum duration of a video recording file is 5 minutes. When it's more than 5 minutes, the video will be recorded onto a new file.
- The number of files is limited by the capacity of the device's built-in memory. Regularly monitor the amount of free memory in the built-in memory card, transferring footage and photos to other media to free up space on the memory card.

## Memory Access

When the device is turned on and connected to a computer, it is recognized by the computer as a flash memory card, which is used to access the device's memory and make copies of pictures and videos.

- Turn on the device and connect it to the computer through the USB cable.
- Double-click "my computer" on the desktop - double-click to open the

device named "Infiray"  - then click and open the device named "Internal Storage"  28.0GB available 28.8GB total to access memory.



- There are different folders named by time in memory.
- Recorded videos and photographs are saved in these folders in the format: IMG\_HHMMSS\_XXX.jpg (for photos) and VID\_HHMMSS.mp4 (for video). HHMMSS- hour/minute/ second; XXX - three-digit common file counter for photos which is NOT reset.

## 13 Shortcut Menu

- In the home screen, press **M (5)** button briefly to enter the shortcut menu interface.
- There are three functions in order of screen brightness, image mode and electronic zoom (only for monocular).
- Press the **P (4) / C (6)** button briefly to set the parameter of each function.
- Press the **M (5)** button briefly to switch to the next function.

- Press and hold the **M (5)** button or repeatedly short press the **M (5)** button to exit to the home screen.

### Shortcut Menu Options and Descriptions

Times of pressing the M (5) button	Operation	Interface
1 time	<p><b>Adjust the screen brightness</b></p> <ul style="list-style-type: none"> <li>➤ There are four levels for selection.</li> <li>➤ Short press the <b>P (4)</b> button to increase the screen brightness level.</li> <li>➤ Short press the <b>C (6)</b> button to reduce the screen brightness level.</li> </ul>	
2 times	<p><b>Select the image mode</b></p> <ul style="list-style-type: none"> <li>➤ There are four modes for selection, in order of White hot (W), Black hot (B), Red hot (R), Pseudo Color (C).</li> <li>➤ Short press the <b>P (4)</b> button to select the image mode clockwise.</li> <li>➤ Short press the <b>C (6)</b> button to select the image mode counterclockwise.</li> </ul>	

<p>3 times</p>	<p><b>Set the E-zoom</b> (only for monocular mode)</p> <ul style="list-style-type: none"> <li>➤ This function is only visible when the Clip C is as a monocular.</li> <li>➤ This function can enlarge the image by 1x, 2x, or 4x.</li> <li>➤ Short press the <b>P (4)</b> button to E-zoom the image clockwise.</li> <li>➤ Short press the <b>C (6)</b> button to E-zoom the image counterclockwise.</li> </ul>	
<p>4 times</p>	<p>Exit to the home screen from Shortcut Menu</p>	<p>—</p>

## 14 Main Menu

In the home screen, press and hold down the **M (5)** button for 3 seconds to enter the main menu interface.

### Operations:

- In the main menu, press the **P (4)** / **C (6)** button briefly to switch the main menu option.
- Press the **M (5)** button briefly to adjust the parameters of present option

or enter the secondary menu.

- Press and hold down **M (5)** button for three seconds to exit from the menu interface to the home screen.







Main menu of Monocular mode







Main menu of Attachment mode









**Main menu function description (when as the attachment)**

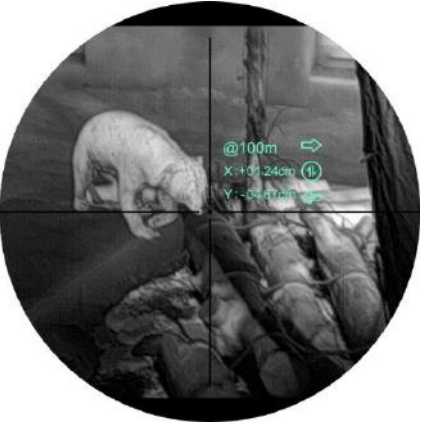

<p style="text-align: center;"><b>Ultraclear Mode</b></p> 	<p><b>Turn Ultraclear mode on/off</b></p> <ul style="list-style-type: none"> <li>➤ Press and hold down the <b>M (5)</b> button to enter the Main Menu.</li> <li>➤ Select the <b>Ultraclear</b> option with the <b>P (4) / C (6)</b> button.</li> <li>➤ Turn the Ultraclear mode on /off with a short press of <b>M (5)</b> button, along with the sound of shutter calibration.</li> <li>➤ The icon will be displayed on the status bar in the upper left corner of the screen when the Ultraclear mode is on.</li> <li>➤ Ultraclear mode will show more image details under the cloudy, rainy, foggy and other harsh weather conditions.</li> </ul> <div style="display: flex; justify-content: space-around;">   </div>
<p style="text-align: center;"><b>Wi-fi</b></p> 	<p><b>Turn Wi-fi function on/off</b></p> <ul style="list-style-type: none"> <li>➤ Press and hold down the <b>M (5)</b> button to enter the Main Menu.</li> <li>➤ Select the <b>Wi-fi</b> option with the <b>P (4) / C (6)</b> button.</li> <li>➤ Turn the Wi-fi function on /off with a short press of <b>M (5)</b> button.</li> <li>➤ The icon will be displayed on the status bar in the screen when the Wi-fi is on.</li> <li>➤ When Wi-fi is on, it can be connected with the APP InfiRay Outdoor.</li> </ul>
<p style="text-align: center;"><b>Bluetooth</b></p> 	<p><b>Turn Bluetooth function on/off</b></p> <ul style="list-style-type: none"> <li>➤ Press and hold down the <b>M (5)</b> button to enter the Main Menu.</li> <li>➤ Select the <b>Bluetooth</b> option with the <b>P (4) / C (6)</b> button.</li> </ul>

	<ul style="list-style-type: none"> <li>➤ Turn the bluetooth function on /off with a short press of <b>M (5)</b> button.</li> <li>➤ A flashing Bluetooth icon will be displayed on the bottom of the screen when the Bluetooth is on.</li> <li>➤ Then it can be connected and operated with the bluetooth remote control (referring to the section Bluetooth Remote Control for details).</li> </ul>
<p style="text-align: center;"><b>Video Output</b></p> 	<p><b>Turn video output on/off</b></p> <ul style="list-style-type: none"> <li>➤ Press and hold down the <b>M (5)</b> button to enter the Main Menu.</li> <li>➤ Select the <b>Video Output</b> option with the <b>P (4) / C (6)</b> button.</li> <li>➤ Briefly press of the <b>M (5)</b> button to turn video out on/off.</li> <li>➤ The icon will be displayed on the bottom of the screen when the video output function is on.</li> <li>➤ Video out function enable connectivity with an external display or recording device.</li> </ul>
<p style="text-align: center;"><b>Auto shutter calibration</b></p> 	<p><b>Turn the Auto shutter calibration on/off</b></p> <ul style="list-style-type: none"> <li>➤ Press and hold down the <b>M (5)</b> button to enter the Main Menu.</li> <li>➤ Select the <b>Auto shutter calibration</b> option with the <b>P (4) / C (6)</b> button.</li> <li>➤ Briefly press of the <b>M (5)</b> button to set the Auto shutter calibration mode on or off.</li> <li>➤ When the Auto shutter calibration is on, the shutter will automatically when the picture quality deteriorates.</li> </ul>
<p style="text-align: center;"><b>Handheld mode</b></p> 	<p><b>Switch between attachment mode and monocular mode</b></p> <ul style="list-style-type: none"> <li>➤ Press and hold down the <b>M (5)</b> button to enter the Main Menu.</li> <li>➤ Select the <b>Handheld mode</b> option with the <b>P (4) / C (6)</b> button.</li> </ul>

	<ul style="list-style-type: none"> <li>➤ Briefly press of the <b>M (5)</b> button to set the Handheld mode on or off.</li> <li>➤ When the handheld mode is on, CH50W will be used as a monocular and the E-zoom function in the shortcut menu will be activated. At the same time, the main menu options will change as the functions of image calibration, zeroing type and time setting are hidden.</li> <li>➤ When the handheld mode is off, CH50W will be used as an attachment, the E-zoom function will be hided.</li> </ul>	
<p style="text-align: center;"><b>Zeroing Type</b></p> 	<p><b>Select the zeroing type (only for Attachment)</b></p> <ul style="list-style-type: none"> <li>➤ Press and hold down the <b>M (5)</b> button to enter the Main Menu.</li> <li>➤ Select the <b>Zeroing Type</b> option with the <b>P (4) / C (6)</b> button.</li> <li>➤ There are four types for selection G1/G2/G3/G4.             <ul style="list-style-type: none"> <li>- G1 and G2 are recommended magnification of the day sight for 1x-4x.</li> <li>- G3 and G4 are recommended magnification of the day sight for 5x-9x.</li> </ul> </li> <li>➤ Briefly press of the <b>M (5)</b> button to select one zeroing type.</li> </ul>	

<p><b>More</b></p> 	<p><b>Enter the secondary menu for more settings (when as Attachment)</b></p> <ul style="list-style-type: none"> <li>➤ When the CH50W is as the attachment, press and hold down the <b>M (5)</b> button to enter the Main Menu.</li> <li>➤ Select the <b>More</b> menu option with the <b>P (4) / C (6)</b> button.</li> <li>➤ Briefly press of the <b>M (5)</b> button to enter the submenu for more settings, including battery type, image calibration, time setting, defective pixels calibration, factory reset and return to the main menu.</li> </ul>	
<p><b>Image calibration</b></p> 	<p><b>Image calibration (only for Attachment)</b></p> <ul style="list-style-type: none"> <li>➤ Select the <b>Image calibration</b> option with the <b>P (4) / C (6)</b> button in the <b>More</b> submenu.</li> <li>➤ Briefly press of the <b>M (5)</b> button to enter the image calibration interface.</li> <li>➤ Calibration the image with the <b>P (4) / C (6)</b> button.</li> <li>➤ Switch the movement direction with a short press of the <b>M (5)</b> button.</li> <li>➤ When the movement is done, long press the <b>M (5)</b> button to save and exit the image calibration function.</li> <li>➤ For the details, please refer to the section <b>Image Calibration</b>.</li> </ul>	
<p><b>Time Setting</b></p> 	<p><b>Time and date setting (only for Attachment)</b></p> <ul style="list-style-type: none"> <li>➤ Select the <b>Time Setting</b> option with the <b>P (4) / C (6)</b> button in the <b>More</b> submenu.</li> <li>➤ Briefly press of the <b>M (5)</b> button to enter the time setting interface.</li> </ul>	

	<ul style="list-style-type: none"> <li>➤ The time and date are displayed as Year. Month. Day   Hour: Minute format.</li> <li>➤ Switch among year, month, day, hour and minute with a short press of the <b>M (4)</b> button. The selected item will turn green and two triangle icons appear above and below the value.</li> <li>➤ Select the correct value with the <b>P (4) / C (6)</b> button.</li> <li>➤ Press and hold the <b>M (5)</b> button to save the setting and exit to the home screen.</li> </ul>	
<p><b>Pixels Defect Calibration</b></p> 	<p><b>Calibrate the defective pixels</b></p> <p>Defect pixels are pixels that do not change brightness compare with others on the image, they are either brighter or darker than surrounding pixels. Clip series offer the possibility of removing any defective pixels on the sensor using software, as well as to cancel any deletion.</p> <ul style="list-style-type: none"> <li>➤ Select the <b>Pixels Defect Calibration</b> option with the <b>P (4) / C (6)</b> button in the <b>More</b> submenu.</li> <li>➤ Briefly press of the <b>M (4)</b> button to enter the pixels defect calibration interface.</li> <li>➤ A small cross cursor will appear on the center of the screen.</li> <li>➤ And then, move the cursor align with the defective pixel with a short or long press the <b>P (4) / C (6)</b> button.</li> <li>➤ Press the <b>M (5)</b> button briefly to switch the movement direction (up-down or right-left).</li> <li>➤ After selecting the defective pixel, press and hold the <b>P (4) + C (6)</b> buttons at the same time to calibrate the defective pixel,</li> </ul>	

	<p>and long press the same button again for cancelation.</p> <ul style="list-style-type: none"> <li>➤ Repeat the above processes until all blind pixels are calibrated.</li> <li>➤ The number of the calibrated blind pixel is displayed at the bottom of the screen.</li> <li>➤ When the calibration is done, press and hold the <b>M (5)</b> button to exit the calibration and back to the home screen.</li> </ul>
<p style="text-align: center;"><b>Factory Reset</b></p> 	<p><b>Reset to the Factory Settings</b></p> <ul style="list-style-type: none"> <li>➤ Select the <b>Factory Reset</b> option with the <b>P (4) / C (6)</b> button in the <b>More</b> submenu.</li> <li>➤ Short press the <b>M (5)</b> button to select whether to restore the factory settings.</li> <li>➤ Select <b>Y</b> or <b>N</b> with the <b>P (4) / C (6)</b> button, and the selected option will turn green.</li> <li>➤ Selecting the “√” is to reset to the default, and the “×” is to and exit to the home screen.</li> <li>➤ Confirm the selection with a short press of the <b>M (5)</b> button.</li> <li>➤ When the “√” is performed, the device will automatically reboot and reset to the factory settings.</li> </ul> 
<p style="text-align: center;"><b>Return</b></p> 	<p><b>Return to the main menu</b></p> <ul style="list-style-type: none"> <li>➤ Select the <b>Return</b> option by <b>P (4) / C (6)</b> button in the <b>More</b> submenu.</li> <li>➤ Short press the <b>M (4)</b> button to return to the upper menu.</li> </ul>

## 15 Time Setting (Only for Attachment)

Time setting function will only enable when the CH50W is used as an attachment.

- In the home screen, long press the **M (4)** button to enter the main menu interface.
- Select the **More** option with the **P (4) / C (6)** button, and enter the submenu with a short press of the **M (5)** button.
- Select the **Time Setting** option with the **P (4) / C (6)** button in the **More** submenu, and enter the time setting interface with a short press of the **M (5)** button.
- The time and date are displayed as Year. Month. Day | Hour: Minute format.
- Switch among year, month, day, hour and minute with a short press of the **M (4)** button. The selected item will turn green and two triangle icons appear



above and below the value.

- Select the correct value with the **P (4) / C (6)** button.
- Press and hold the **M (5)** button to save the setting and exit to the home screen.

## 16 Wi-Fi function

Clip CH50W is equipped with a Wi-Fi module, which enables the device to connect wirelessly to the external devices such as computers and smart phones.

- In the home screen, press and hold the **M (5)** button to enter the menu.
- Select the **Wi-Fi** option with the **P (4) / C (6)** button.
- Briefly press of the **M (5)** button to turn the Wi-Fi function on.
- Search the Wi-Fi named "CH50W\_XXXXXX" on your external device, where XXXXXX represents the SN code of the device.
- Select the Wi-Fi and enter the password to establish a connection. The initial password is 12345678.
- And then, the device can be controlled through the InfiRay Outdoor.

## Set Wi-Fi name and password

The Wi-Fi name and password of your device can be set in the APP.

- In APP, select and click the "Settings" icon  to enter the Settings interface.
- In the text box, enter and submit the new Wi-fi name (SSID) and password.
- It needs to restart the device to take the new name and password effect.

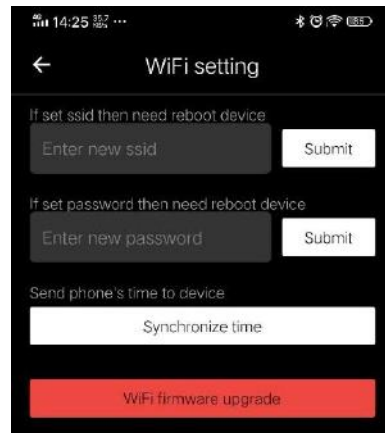

### Note

- Restore factory settings, the Wi-Fi name, password, and system time are restored to the factory default Settings.

## 17 Bluetooth Remote Control



Clip C Series is equipped with external devices that can be connected via bluetooth. The key layout of bluetooth remote control and mobile phone APP is consistent with the key on the Clip C device, including power button, menu button and correction button. The functions and operation methods are also corresponding with Clip C device.

- Turn on the Bluetooth function of the device (referring to the **Main Menu - Bluetooth**).
- Long press the **Power** button on the remote control for 15 to 30s until the bluetooth icon on the screen turns to , which means the connection is done and the remote control is ready to use.



- After connecting to the device, if the signal is lost, the remote control will continue to search for connection within 1 minute.
- The remote control will automatically shut down if no bluetooth signal is found within 1 minute.

## 18 Technical Inspection

A technical inspection of the device is recommended before use.

- Check the external appearance of the device (there should be no cracks in the casing).
- Check the condition of the lens and eyepiece (there should be no cracks, greasy spots, dirt or other deposits)
- Check the condition of the rechargeable battery (this should be charged) and the electrical contacts (there should be no presence of salts or oxidation).

## 19 Maintenance

Maintenance should be carried out at least twice a year and consist of the following actions.

- Wipe the external surfaces of metal and plastic parts free of dust and dirt with a cotton cloth. Silicone grease maybe used for this.
- Clean the electrical contacts of the battery and battery slot on the unit using a non-greasy organic solvent.
- Check the glass surfaces of the eyepiece and the lens. If necessary, remove dust and sand from the lenses (preferably using a non-contact method). Cleaning of the external surfaces of the optics should be done with substances designed especially for this purpose.

## 20 General Trouble Shooting

The table lists all the problems that may occur when operating the device. Carry out the recommended checks and troubleshooting steps in the order shown in the table. If there are defects that are not listed in the table or it

is impossible to repair yourself, please contact with us as soon as possible. Private demolition is strictly prohibited.

Trouble description	Probable reason	Trouble shooting
Fail to start up	Wrong battery installation.	Reinstall the batteries observing polarity
	Batteries are fully exhausted or low power.	Change and install new batteries.
	Battery cover is not tightly closed.	Close tightly the battery cover.
Fail to work with an external power supply	Insufficient external supply voltage.	Check the voltage of external power supply.
Image is fuzzy, not clear, with vertical stripes and uneven background.	No calibration for a long time.	Perform the calibration according to the section Operation.
Image is too dark.	Low screen brightness.	Adjust the screen brightness.
Blurred image with clear GUI	The objective lens is not focused.	Adjust the focus ring of the objective lens until the image becomes clear.
	There is dust or condensate on the interior or exterior optical surfaces of the lens.	Wipe off the outside optical surfaces with a soft cotton cloth. Let it dry by leaving it in a warm environment for 4 hours.
No analog video output	The video out function is not turned on.	Turn the video out function in the Main Menu.
	Data cable doesn't support data transmission.	Replace a new data cable.
Point of impact does not match the aiming point.	Image calibration needs to be done.	Do image calibration according to the section 13 Image Calibration.

## 21 Legal and Regulatory Information

Wireless transmitter module frequency range:

**Bluetooth: 2.402-2.480GHz (For EU)**

Wireless transmitter module power<20dBm (only for EU)

 IRay Technology Co., Ltd. thus declares that the Clip C series complies with the directives 2014/53/EU and 2011/65/EU. The full text of the EU declaration of conformity as well as additional information are available at: [www.infirayouordoor.com](http://www.infirayouordoor.com).

 This device may be operated in all member states of the EU.

### FCC Statement

**FCC ID: 2AYGT-CLIP**

#### Labeling requirements

This device complies with part 15 of the FCC Rules. Operation is subject to

the following two conditions: (1) This device may not cause harmful interference, and (2) this device must accept any interference received, including interference that may cause undesired operation.

#### Information to the user

Any Changes or modifications not expressly approved by the party responsible for compliance could void the user's authority to operate the equipment.

**Note:** The manufacturer is not responsible for any radio or TV interference caused by unauthorized modifications to this equipment. Such modifications could void the user's authority to operate the equipment.

**Note:** This equipment has been tested and found to comply with the limits for a Class B digital device, pursuant to part 15 of the FCC Rules. These limits are designed to provide reasonable protection against harmful interference in a residential installation. This equipment generates uses and can radiate radio frequency energy and, if not installed and used in accordance with the instructions, may cause harmful interference to radio communications. However, there is no guarantee that interference will not occur in a particular installation. If this equipment does cause harmful

interference to radio or television reception, which can be determined by turning the equipment off and on, the user is encouraged to try to correct the interference by one or more of the following measures:

- Reorient or relocate the receiving antenna.
- Increase the separation between the equipment and receiver.
- Connect the equipment into an outlet on a circuit different from that to which the receiver is connected.
- Consult the dealer or an experienced radio/TV technician for help.

The device has been evaluated to meet general RF exposure requirement.

The device can be used in portable exposure condition without restriction.

### **Body-worn Operation**

This device was tested for typical body-support operations. To comply with RF exposure requirements, a minimum separation distance of 0.5cm must be maintained between the user's body and the handset, including the antenna. Third-party belt-clips, holsters, and similar accessories used by this device should not contain any metallic components. Body accessories that do not meet these requirements may not comply with RF exposure

requirements and should be avoided. Use only the supplied or an approved antenna.

We, IRay Technology Co., Ltd., hereby declare that this product was tested conforming to the applicable FCC rules under the most accurate measurement standards possible, and that all the necessary steps have been taken and are in force to assure that production units of the same equipment will continue to comply with the Commissions requirement.