



FL35R/FH35R

FINDER II

Thermal Imaging Monocular

Operating Manual



IRay Technology Co., Ltd.

Add: 11th Guiyang Street, YEDA, Yantai 264006, P.R. China

Tel: 0086-400-998-3088

Web: www.infirayoutdoor.com

Email: infirayoutdoor@infiray.com



www.infirayoutdoor.com

WARNING!

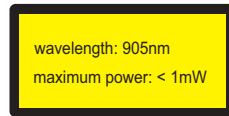

Information for the user

An additional warning for Class 1M and 2M laser products. This warning shall state that viewing the laser output with telescopic optical instruments (for example, telescopes and binoculars) may pose an eye hazard and thus the user should not direct the beam into an area where such instruments are likely to be used.

SPECIFICATION

Model	FL35R	FH35R
Microbolometer		
Resolution, pixels	384 x 288	640 x 512
Pixel size, μm	12	
NETD, mk	≤ 40	≤ 35
Frame refresh rate, Hz	50	
Optical Specifications		
Objective Lens, mm	35 / F1.0	
Field of view, degree	7.5 x 5.7	12.6 x 10.1
Optical magnification, x	3.4 ~ 13.6	2 ~ 8
Digital zoom, x	1 / 1.5 / 2 / 2.5 / 3 / 3.5 / 4	
Minimum focusing distance, m	1	
Focusing range of eyepiece, D	-5 ~ +5	
Detection range, m (Target size: 1.7mx0.5m, P(n)=99%)	1818	
Display		
Type	OLED	
Resolution, pixels	1024 x 768	
Operational Specifications		
Battery type	Li-ion battery pack	
Max. battery life(t=25°C)*, h	6	5.5
Laser rangefinder range, m	800 \pm 1	
Amount of built-in memory, GB	32	
APP compatibility	Support	
Dimension, mm	160 x 90 x 50	
Weight, g	≤ 400	
IP code	IP67	
Operation temperature, °C	-20 ~ +50	

* Actual operation time depends on the intensity of Wi-Fi use and the built-in video recorder.

PACKAGE CONTENTS

- Finder II Thermal Monocular
- Portable Bag
- Type C USB cable
- HDMI cable
- Power adapter
- IBP-2 battery pack *2
- IBC-2 battery charger
- Hand strap
- Neck strap
- Cloth for cleaning optics
- Operating manual

* Improvements may be made to the design and software of this product to enhance its useful features.

* Technical parameters of the device may be improved without prior notice of the customer.

DESCRIPTION

The Finder II series are easy to carry and can be operated with one hand. With its compact size and light weight, it can be placed in the pocket any time. The built-in laser ranging can quickly locate the target distance. The ergonomic construction and powerful function make the Finder II series to be the best choice for outdoor exploration.

DISTINGUISHING FEATURES

- 12 μm thermal imaging detector
- High image quality
- Integrated laser rangefinder
- Display off function
- OLED display
- Long detection distance
- Ultraclear mode for harsh weather conditions

- Cool hue and warm hue for selection
- 32GB Build-in memory
- Support photo and video recording
- Support APP connection via Wi-Fi
- Built-in digital compass and motion sensor
- Replaceable Battery Pack
- Convenient user interface

UNITS AND CONTROLS

1. Lens cap
2. Lens focus ring
3. Power button
4. Menu button
5. Up/Ranging button
6. Down/Photo button
7. Laser rangefinder
8. IBP-2 battery pack
9. Eyepiece
10. Infrared sensors switch
11. Eyepiece diopter adjustment
12. LED indicator
13. Type C port
14. HDMI port



LED indicator displaying the current status of the device

LED Color	LED Status	Operating Mode
●	Normal	Fully charged
	Flashing	Standby
●	Normal	Charging
	Flashing	Less than 10% battery level

BATTERY AND SAFETY

Finder II series is supplied with a quickly removable 18650 Li-ion battery pack, which enabled the device to be used for up to 5.5h. The battery should be fully charged before first use.

Battery Pack Installation

- Turn up the puller (15) on the battery pack (8), and align the orange line (D) on the battery pack (8) with the triangle symbol (C) on the battery slot (16) and push the battery pack (8) into the battery slot (16).
- When the battery pack is completely inserted into the battery slot, turn the puller (15) clockwise to lock the battery pack.
- Close the puller (15), and the battery pack is completely installed.
- Finder II series can only be powered by this battery pack. If other battery packs are used, it may cause irreparable loss, damage to the device, and can even possibly cause fire.

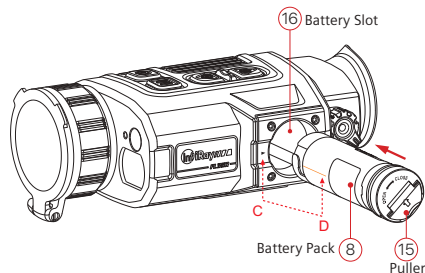

Method 1: Charging with Type-C Port

- Align the orange vertical line on the battery pack with the white triangle symbol next to the battery compartment on the Finder II, and install the battery pack into the battery compartment of the product. For details, see **Battery Pack Installation**.
- Connect the Type C end of the data cable (18) to the Type C port (13) of the product.
- Connect the other end of the data cable (18) to the power adapter (19) that comes with the product, or connect to another USB power socket with a rated output voltage not exceeding 5V.
- Plug the adapter (19) into a 100-240V power socket (20) for charging.
- when charging, the LED indicator will change to red.

LED indicator displaying the current status of the device

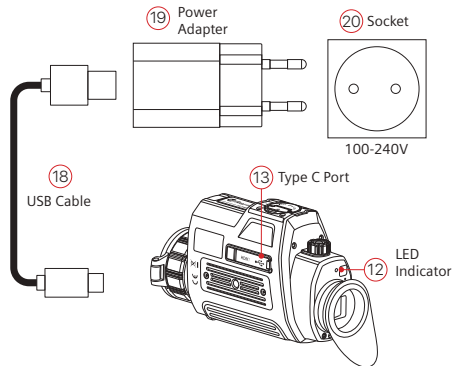



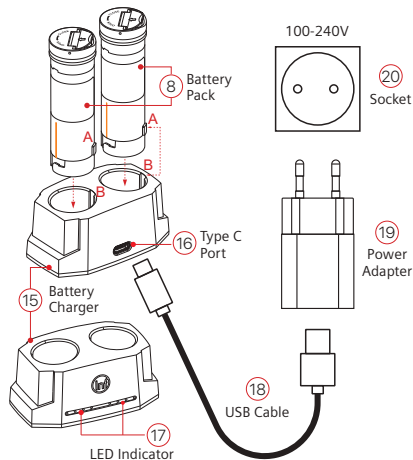

Method 2: Charging with Battery Charger

- Align the positioning block (A) of the battery pack (8) with the groove (B) of the battery charger (15), and insert the battery pack (8) into the battery charger (15).
- Connect the plug of the USB Type-C cable (18) to the USB connector of the power adapter (19). Plug the power adapter (19) into a socket 100-240V (20) (110V for US).
- Connect the other end of the USB cable (18) to the Type-C port (16) of the battery charger (15).
- After finishing the above steps, the LED indicator (17) on the battery charger (15) will display the battery charge state.
- After the battery is fully charged, remove the battery pack from the battery charger.



Battery charge status (see table).

LED Indicator	Battery charge status
	Battery level is from 1% to 25%.
	Battery level is from 25% to 50%.
	Battery level is from 50% to 75%.
	Battery level is from 75% to 99%.
	Battery is fully charged.

Note: Two batteries can be charged at the same time: the second slot is designed for it.



Safety Measures

- Use this battery charger to charge the battery pack only. Otherwise it will cause irreparable damage to the battery pack or charger and even may cause fire.
- Before a long storage time, the battery pack should be partially charged, not fully charged or discharged.
- Do not charge the battery immediately after you bring it from the cold to the warm. Wait 30 to 40 minutes for it to warm up.
- Do not use the charger if it is modified or damaged.
- The device should be charged at a temperature of 0°C ~ +45°C. Otherwise the battery life will be significantly reduced.
- When charging, please don't leave the battery unattended.
- Do not expose the battery to high temperature or open flame.
- Do not immerse the battery in water.
- The battery pack has short circuit protection. But situations that may lead to short circuits should be avoided.
- Do not charge the battery for more than 24 hours after it is already fully charged.



- It is not recommended to connect third-party devices that consume more power than allowed.
- Do not disassemble or modify the battery pack without professional instructions. Do not knock or drop the battery pack.
- The recommended operating temperature for the device is -20°C ~ +50°C. Do not use the device beyond this temperature range, which may shorten the battery life.
- When the device is used under sub-zero temperature, the battery capacity drops, which is normal and does not indicate a defect.
- Please keep the battery pack out of the reach of children.

EXTERNAL POWER SUPPLY

Finder II series supports external power supply, such as the portable power source (5V).

- Connect the external power supply to the **Type-C port (13)** of the device.
- The device will automatically switch to the external power supply and charge the **battery pack (8)** at the same time.
- At this time, the battery icon on the display will become to the charging icon  and the power indicator will turn red, and then turn green after the battery is fully charged.
- If an external power supply is connected, but no battery pack is installed, the battery icon will become a USB icon  and the power indicator will turn green.
- When the external power supply is disconnected, Finder II series will automatically switch to the battery pack power supply and will not shut down.

BUTTON OPERATIONS

Button	Device status / operation mode	First short press	Next short press	Long press
Power button 	The device is off.	--	--	Power on device
	Home screen state	Standby	Wake up the device	Power off device
	Defective pixels calibration interface	calibrate a defective pixel	Undo the pixel calibration	Cancel all calibrations of this operation with shutter correction
	Shortcut menu/ Main menu	Return to the home screen	Standby	--
Menu button M	Home screen state	Open shortcut menu 1	Open shortcut menu 2	Open main menu
	Shortcut menu 1	Open shortcut menu 2	Exit the shortcut menu	--
	Shortcut menu 2	Exit the shortcut menu	Open shortcut menu 1	--
	Main menu	Confirm value, enter menu option	Confirm value, enter menu option	Exit menu option / main menu
	Defective pixels calibration interface	Switch cursor movement direction	Switch cursor movement direction	Save and exit calibration
Up/ Ranging button 	Home screen state	Turn on the laser ranging function	--	--
	Laser ranging mode	Single ranging	--	Switch ranging mode between single and continuous mode
	Shortcut menu 1	Adjust E-zoom	Adjust E-zoom	--
	Shortcut menu 2	Adjust display brightness	Adjust display brightness	--
	Main menu	Navigation up	Navigation up	--
Down/ Photo button 	Defective pixels calibration interface	Move one pixel up/ right	Move one pixel up/ right	Move ten pixels up/ right
	Home screen state	Take a photo	Take a photo	Start video recording
	Video recording	Take a photo	Take a photo	Stop and save video recording
	Shortcut menu 1	Image mode adjustment	Image mode adjustment	--
	Shortcut menu 2	Adjust image sharpness	Adjust image sharpness	--
	Main menu	Navigation down	Navigation down	--
Up+ Down	Defective pixels calibration interface	Move one pixel down/left	Move one pixel down/left	Move ten pixels down/left
	Home screen state	Shutter correction	Shutter correction	Background correction

MENU/STATUS BAR ICONS

	White Hot
	Black Hot
	Red Hot
	Target Highlight
	Ironbow
	Rainbow
$\times 1 / \times 1.5 / \times 2 / \times 2.5 / \times 3 / \times 3.5 / \times 4$	Digital zoom
	Display brightness
	Image sharpness
	Automatic calibration
	Manual calibration
	Ultraclear mode
	Wi-Fi
	Video out
	PIP
	Digital compass
	Motion sensor
	Auto display off
	Microphone
	Switch unit
	More
	Calibration mode
	Image Hue
	Defective pixel calibration
	Compass calibration
	Time and Date
	System information

	Factory reset
	Return to the Main Menu
	Single ranging
	Continuous ranging
	Battery indication
	Battery charging

OPERATION

WARNING! The lens of Finder II series must not be pointed at any sources of intense energy, such as laser-emitting devices or the sun. This may damage the electronic components in the device. Damage caused by failure to comply with the operating guidelines is not covered under warranty.

Power on and image adjustment

- Remove the **lens cap (1)**. Press and hold the **Power (3) button** for 2s to power on the device. Then, the home screen appears after 10s.
- Rotate the **eyepiece diopter adjustment (11)** to adjust the resolution of the icons on the display. After the adjustment is completed, for the same user, when using it again there is no need to adjust the diopter again.
- Rotate the **lens focus knob (2)** to focus on the object observed.
- Set the digital zoom, image mode, screen brightness and image sharpness with a short press of the **Menu (4) button** (Refer to the **Shortcut Menu** section in this manual for details).

Shut Down

- After using the device, press and hold the **Power (3)** button for 3 seconds. The shutdown countdown screen will appear.
- When the countdown from 3 to 0 is completed as indicated by the countdown icon, the device is powered off. Then release the button. The display is off, the indicator is off, and the device is shut down.



Standby

- The standby mode can let the device into a sleep state (turn off the display screen, the main chip is standby).
- During use, press the **Power (3)** button briefly, which allows it to be quickly turned off, if necessary.
- Press the **Power (3)** button again to wake up the device.

HOME SCREEN

When the device booted up, the home screen shows upon. There is some general information shown on the interface. Detail as follows:

- **Upper left corner**--Color palette, magnification, calibration mode, Wi-Fi (on), Ultraclear mode (on), Microphone (on), Automatic screen off (on),
- **Upper right corner**--Battery level

- **Lower left corner**--Time and date
- **Lower right corner**--Video output icon (on).



The color of the battery icon represents the current battery level. When the battery icon is shown in red, it indicates that the battery is low. Please charge it in time.

Icon	Color	Battery level
	Blue	30%-100%
	Yellow	20%-30%
	Red	Less than 10%
	---	Charging

CALIBRATING THE SENSOR

When the image is degraded or uneven, it can be improved by calibration. Calibration enables the detector temperature background to be equalized and defects in the image to be eliminated.

There are two calibration modes: manual calibration (M) and automatic calibration (A).

Select the required mode in the **CALIBRATION** section of the **MAIN MENU**.

- **A mode (automatic)**. The device is calibrated autonomously by the software algorithm. The lens cap need not be secured (the sensor is closed by an internal shutter).

- **M mode (manual).** The device needs to be calibrated manually.
 - Short press the **Up (5)+Down (6)** button for shutter calibration, and long press for background calibration.
 - The lens cap should be closed for background calibration.

 **Note**

- Manual shutter calibration and manual background calibration are still possible even in mode A.
-

PHOTOGRAPHING AND VIDEO RECORDING

Finder II Series thermal imager is equipped with a function for video recording and photographing an observed image onto the built-in memory card.

The files of images and videos will be named after the time, so it is recommended to reset the system time in the **Main Menu** or to synchronize the system time and date in the Settings of the APP before using the photo and video function. For specific operations, you can download the operating instructions of the APP from the company's website.

Photographing

- Take a photograph with a short press of the **Down/Photo (6)** button in the home screen. The image freezes for 0.5 seconds with a photo icon (📷) displayed on the upper-right corner of the display.
- The picture file is saved to the build-in memory card.

Video Recording

- In the home screen, press and hold the **Down/Photo (6)** button to start video recording.
- A tooltip  showing the recording time (showing in MM:SS (minutes: seconds) format) will appear in the upper right corner of the display.
- The red dot in the tooltip flashes during recording.
- During recording, short press the **Down/Photo (6)** button to take a photo also.
- Stop the video recording by pressing and holding down the **Down/Photo (6)** button.
- Video and picture files are stored in the built-in memory card after video recording has been turned off.



 **Note**

- You can enter and work on the menu during video recording.
 - The recording time is accumulated in minutes until the recording stops, that is, the time shows 60:00 after 59:59.
 - The maximum duration of a video recording file is 10 minutes. When it's more than 10 minutes, the video will be recorded onto a new file.
 - The number of files is limited by the capacity of the device's built-in memory. Regularly monitor the amount of free memory in the built-in memory card, transferring footage and photos to other media to free up space on the memory card.
-

Memory Access





When the device is turned on and connected to a computer, it is recognized by the computer as a flash memory card, which is used to access the device's memory and make copies of pictures and videos.

- Turn on the device and connect it to the computer through the USB cable.

- Double-click "my computer" on the desktop - double-click to open the device named "Infiray"  - then click and open the device named "Internal Storage"  to access memory.
- There are different folders named by time in memory .
- Recorded videos and photographs are saved in these folders in the format: IMG_HHMMSS_XXX.jpg (for photos) and VID_HHMMSS.mp4 (for video). HHMMSS- hour/minute/second; XXX - three-digit common file counter for photos which is NOT reset.

LASER RANGEFINDER FUNCTION

FL35R/FH35R is built-in laser rangefinder module.

- Short press the **Up/Ranging (5)** button to switch on the laser rangefinder function in the home screen.
- A blue cursor  appears automatically on the screen, and the tooltip  239m at the bottom of the screen displays the current ranging mode and the distance of the target indicated by the cursor.
- There are two kinds of ranging modes: single ranging  and continuous ranging . Press and hold the **Up/Ranging (5)** button to switch between the two modes.



- In the single ranging mode, short press the **Up/Ranging (5)** button is required for ranging.

- In the continuous ranging mode, the distance of the target indicated by the cursor will be refreshed automatically every 1 second, without any keystroke operation.
- The measurement range and accuracy is 800m±1m, and it will be affected by fog and heavy rain and other weather.
- After the measurement is completed, short press the **Power (3)** button to exit the laser rangefinder function.

SHORTCUT MENU FUNCTION

The basic settings (use of the smooth digital zoom function, display brightness adjustment, image mode and sharpness adjustment) are changed via the Shortcut Menu.

- In the home screen, by pressing the **Menu (4)** button to enter shortcut menu 1-shortcut menu 2-exit the menu accordingly.
- After entering the menu, press the **Up (5)** button to set the parameters at the top of the screen and press the **Down (6)** button to set the parameters at the bottom of the screen.



- ▶ **Smooth Digital Zoom-** by pressing the **Up (5)** button to change the digital zoom value from 1.0 to 4.0 in the shortcut menu 1.
- ▶ **Image Mode-** by pressing the **Down (6)** button to change the image mode in the shortcut menu 1. The icons from left to right are white hot, black hot, red hot, hot target highlight, ironbow and rainbow.

- ▶ **Display Brightness**- by pressing the **Up (5)** button to change the display brightness level from 1 to 4 in the shortcut menu 2.
- ▶ **Image Sharpness**- by pressing the **Down (6)** button to change the image sharpness level from 1 to 4 in the shortcut menu 2.
- An automatic exit from the menu occurs after 10 seconds of inactivity. Also, it will return to the home screen quickly with a short press the **Power (3)** button.

MAIN MENU FUNCTIONS

- Enter the menu with a long press of the **Menu (4)** button in the home screen.
- Press the **Up (5) / Down (6)** buttons to move through the menu functions, and the background of the option will become blue simultaneously.
- Press the **Menu (4)** button to set the parameters of the current option, or open the menu item.
- On the "**More**  "option, short press the **Menu (4)** button to enter the sub menu for more settings.
- The button operation of the sub menu is the same as that of the Main Menu.
- Press and hold down the **Menu (4)** button to exit the menu.
- An automatic exit from the menu occurs after 10 seconds of inactivity. Also, it will return to the home screen quickly with a short press the **Power (3)** button.



Composition and Description of the Main Menu

- 👁 **Ultraclear** - Selection of the Ultraclear mode
 - Press and hold the Menu button (4) to enter the menu.
 - Select the 'Ultraclear' option.
 - Short press Menu button (4) to turn the Ultra-clear on/off.
 - When the Ultraclear mode is on, the image contrast is enhanced, which is suitable for rainy, foggy and other harsh weather conditions.
- 📶 **Wi-Fi** - Selection of the Wi-Fi function
 - Press and hold the Menu button (4) to enter the menu.
 - Select the 'Wi-Fi' option.
 - A short press of the Menu button (4) switches the Wi-Fi on/off.
 - The Wi-Fi icon is displayed in the upper-left status bar when it is on.
- 📺 **Video Out**-Selection of the video out function
 - Press and hold the Menu button (4) to enter the menu.
 - Select the 'Video out' option.
 - A short press of the Menu button (4) switches the video out on/off.
 - The Video out icon is displayed in the lower-right corner when it is on.
- 🖼 **PIP Mode**- Selection of the Picture in Picture Mode
 - Press and hold the Menu button (4) to enter the menu.
 - Select the 'PIP Mode' option.
 - Switch the mode on/off with a short press of the Menu button (4).
 - A 2x magnified image in a separate 'window' appears at the top of the display simultaneously with the main image.

- Ⓐ **Digital Compass** - Selection of the Digital Compass
 - Press and hold the Menu button (4) to enter the menu.
 - Select the 'Digital Compass' option.
 - A short press of the Menu button (4) switches the compass on/off.
 - The compass bearing is displayed in the top center of the image.

- 📏 **Motion Sensor** - Selection of the Motion Sensor
 - Press and hold the Menu button (4) to enter the menu.
 - Select the 'Motion Sensor' option.
 - Switch the Motion sensor function on/off with a short press of the Menu button(4) .

When enabled, relevant functions will appear on the right side of the image, that the horizontal scale plate represents the dip angle, while the vertical represents the pitch angle.



- ☐ **Automatic Display-off** - Selection of the Auto Display-off
 - Press and hold the Menu button (4) to enter the menu.
 - Select the 'Automatic Display-off' option.
 - A short press of the Menu button (4) switches on/off.
 - The icon is displayed in the upper-left status bar when it is on.

- 🎤 **Microphone**- Selection of the Mic function.
 - Press and hold the Menu button (4) to enter the menu.
 - Select the 'Microphone function' option.
 - Press the Menu (4) button to switch the MIC on/off.
 - The icon is displayed on the status bar when it is on.

- ☑ **Length Unit** - Selection of the length unit

There are two units for selection: meter (M) and yard (Y).

 - Press and hold the Menu button (4) to enter the menu.
 - Select the 'Length Unit' option.
 - Briefly press the Menu button (4) to select M or Y.

- ⊞ **More** - Get more settings
 - Press and hold the Menu button (4) to enter the menu.
 - Select the 'More' option.
 - A short press of the Menu button (4) to enter the sub menu for more settings.

- ⊗ **Calibration Mode** - Selection of calibration mode.

There are two calibration modes: automatic(A) and manual(M).

 - Press and hold the Menu button (4) to enter the menu.
 - Select the 'Calibration Mode' option.
 - A short press of the Menu button (4) to select A or M.

Automatic(A) Ⓐ

Calibration requirements in the automatic mode are determined by the software algorithm, with the calibration process being started automatically.

Manual(M) Ⓜ

The user independently sets the calibration requirements according to the image being observed.

- ✨ **Image Hue** - Selection of image hue.

There are two hues for selection: cool (C) and warm (W).

 - Press and hold the Menu button (4) to enter the menu.
 - Select the 'Image Hue' option.
 - A short press of the Menu button (4) to select C or W.
 - The switch between the warm and cool hues is not appears at the top of the display simultaneously with the main image.

Cold hue mode (C)

Image will be more contrast, more hierarchy, and more obvious targets.

Warm hue mode(W)

Image will be softer, it can be reducing the visual fatigue of the observer, and long time observation is not dazzling.

⊕ Defective Pixels Calibration

When using the device, defective (broken) pixels may appear on the sensor: i.e., bright or dark points of constant brightness that are visible on the image. Finder II Series offers the possibility of removing any defective pixels on the sensor, as well as to cancel any deletion.

- Open the sub menu by pressing the Menu button (4).
- Select the 'Defective Pixels Calibration' option
- Enter the Defective Pixels Calibration interface with a short press of the Menu button (4).
- A white cross cursor will appear on the display.
- A 2x magnified image of the cross cursor area (PIP) will appear on the lower-left corner of the display that is required to facilitate a search for the defective pixel and to align the marker with it.
- A tooltip will appear at the bottom of the display, which displays the current number of defective pixels calibrated, the moving direction (horizontal ↔ and vertical ↕ directional arrows) and the position of the cursor.
- The horizontal and vertical arrows indicate to move the cursor with the coordinates along the X and Y axes.
- A short press of the Menu button (4) switches the cursor direction from the



horizontal to the vertical and vice versa.

- The icon and text will be changed from white to blue when this direction is activated.
- Use the Up (5)/Down (6) buttons to move the cursor to align its centre with the defective pixel. With a short press to move 1 pixel and long press to move 10 pixels each time.
- After the cursor aligns with the defective pixel, delete the defective pixel with a short press of the Power button (3).
- Then, by moving the cursor across the display, you can delete the next defective pixel.
- Short press the Power button (3) again in the same position to undo the calibration.
- Each time you add or reduce a blind pixel, the number of defective pixels calibrated in the tooltip will change accordingly.
- Long press the Power button (3) to cancel all calibrations done this operation.
- When the cursor is moved near the PIP and prompt box, the PIP and prompt box are automatically moved to the top of the display.
- To exit and save the Defective Pixels Calibration function, press and hold down the Menu button(4).
- No operation within the 10s will exit the interface without saving data.

⊙ Compass Calibration - Calibrate the digital compass

- Open the sub menu by pressing the Menu button (4).
- Select the 'Compass Calibration' option with the Up (5) / Down (6) button.
- Enter the compass calibration interface with a short press of the Menu button (4).
- An icon like a triaxial coordinate appears on the screen.

- Rotate the device at least one 360° in three axial directions in 25 seconds according to the direction shown as the icon to complete the compass calibration.



- Press the Power button (3) briefly to terminate and exit the calibration without saving within 25 seconds.

⌚ Time Settings - Reset the system date and time

- Open the sub menu by pressing the Menu button (4).
- Select the 'Time Settings' option
- Enter the time settings interface with a short press of the Menu button (4), that is displayed as Year. Month. Day | Hour: Minute format.
- Short press the Menu (4) button to switch between digits.
- Select the correct value with a short press of the Up (5)/ Down (6) button.
- Long press the Menu button (4) to exit to the upper interface.



i System Information - View system information of this device

- Open the sub menu by pressing the Menu button (4).
- Select the 'System Information' option
- Open the system information box with a short press of the Menu button (4).
- Long press the Menu button (4) to exit to the upper interface.

↻ Factory Reset - Restore Factory Settings

- Open the sub menu by pressing the Menu button (4).
- Select the 'Factory Reset' option
- Enter the 'Factory Reset' sub menu with a short press of the Menu button (4).
- Select the option '✓' to reset to factory settings or 'X' to cancel with the Up (5) / Down (6) buttons.
- Confirm your selection with a short press of Menu button (4).



The following settings will be restored to their factory state before being set by the user:

Image mode -white hot **Image sharpness** - level 1
Digital zoom -x1 **Display brightness** - level 3
Image hue - warm **Calibration mode** - A
System time - 00:00 2020/01/01
Video out / PIP / MIC / Compass / Motion sensor - off
Automatic Display off/Ultraclear mode / Wi-Fi - off

⚠ Note

- Restore factory settings will format memory, so please save the data in advance.
- Restore factory settings, the defective (broken) pixels that has been calibrated may reappear.

↶ Return To The Main Menu

- Open the sub menu by pressing the Menu button (4).
- Select the 'Return to Main Menu' option
- Return to the main menu with a short press of the Menu button (4).

Wi-Fi FUNCTION

The Finder II series is equipped with wireless communication with external devices (computer, smartphone) via Wi-Fi.

- Press and hold the **Menu (4)** button to enter the menu.
- Select the 'Wi-Fi' option.
- A short press of the **Menu (4)** button switches the Wi-Fi on.
- The device is recognized by an external device under the label 'Finder_xxxxx-xxxxxx', xxxxx-xxxxxx is the SN code of the device.
- Enter the password on an external device, and establish a connection. The initial password is 12345678.
- And then, the device can be controlled through the APP.

Set Wi-Fi name and password

The Wi-Fi name and password of your device can be set in the APP.

- Click the "setting" icon  in the APP to enter the setting interface.
- In the text box, enter and submit the name (SSID) and password of the new Wi-Fi.
- It needs to restart the device to take the new name and password effect.



Note

- When factory Settings are restored, the Wi-Fi name and password are also restored to factory default Settings.

PIP FUNCTION

PIP (Picture in Picture) function enables you to view a magnified digital zoom image in a separate 'window' simultaneously with the main image.

- Press and hold the **Menu (5)** button to enter the menu.
- Select the 'PIP Mode' option.
- A short press of the **Menu (5)** button switches the mode on/off.
- A separate window appears at the top of the display simultaneously with the main image.
- The image in the separate window is captured from the center area of the main image and then 2x magnified. But when the laser cursor is on, the PIP image is the image centered on the laser cursor center.

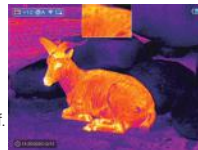

UPDATE AND APP TECHNOLOGY

In order to continuously improve the product performance and provide better user experience, the software program, as well as parameters and operating instruction of the device will be constantly updated. Users can go to the official website (www.infirayoutdoor.com) to download and update.

The Finder II series support APP technology, and can be connected to a smartphone or tablet PC via Wi-Fi for real-time image transmission, control operations, and program updates.

About InfiRay Outdoor

- You can download and install the **InfiRay Outdoor** app on www.infirayoutdoor.com or



App store. Otherwise, you can download the app by scanning the QR code.

- When installation completed, open **InfiRay Outdoor** application.
- If your device is already connected with a mobile device, please switch on the mobile data in mobile device. After connection, the update detection is performed automatically with a prompt in the application. Click '**Now**' to download the updates or click '**Later**' to update later.
- **InfiRay Outdoor** will automatically store the last connected device. So, if your device has not connected with your mobile device, but linked to **InfiRay Outdoor** before, the update prompt will appear if there is an update when turning on **InfiRay Outdoor**. You can download the update first via mobile Wi-Fi and then connect your device with mobile device to finish the update.
- After finishing the update, the device will root.
- Instructions for using **InfiRay Outdoor** can also be downloaded from the official website.

TECHNICAL INSPECTION

A technical inspection of the device is recommended before use.

- Check the external appearance of the device (there should be no cracks in the casing).
- Check the condition of the lens and eyepiece (there should be no cracks, greasy spots, dirt or other deposits)
- Check the condition of the rechargeable battery (this should be charged) and the electrical contacts (there should be no presence of salts or oxidation).

MAINTENANCE

Maintenance should be carried out at least twice a year and consist of the following actions.

- Wipe the external surfaces of metal and plastic parts free of dust and dirt with a cotton cloth. Silicone grease may be used for this.
- Clean the electrical contacts of the battery and battery slot on the unit using a non-greasy organic solvent.
- Check the glass surfaces of the eyepiece and the lens. If necessary, remove dust and sand from the lenses (preferably using a non-contact method). Cleaning of the external surfaces of the optics should be done with substances designed specially for this purpose.

TROUBLESHOOTING

This table lists all the problems that may arise when operating the device. Carry out the recommended checks and repairs in the order shown in the table. If a defect should occur that is not listed in the table, or if it is impossible to repair the defect yourself, the device should be returned for repair.

Malfunction	Possible reason	Correction
Thermal imager does not be powered on.	Battery completely discharged	Charge the battery
Does not operate from external power source.	USB cable damaged External power source discharged	Replace USB cable Charge external power source (if necessary).

Malfunction	Possible reason	Correction
Image is unclear, with vertical lines and uneven background.	Calibration required	Perform image calibration according to Section 'Calibration' of the Manual.
The image is too dark.	Low brightness level set.	Adjust display brightness.
Colored lines appeared on display or the image has disappeared.	The device was exposed to static electricity during operation.	After exposure to static electricity, the device may either reboot automatically or require turning off and on again.
Poor image quality/ reduced detection distance	These problems may occur during observation in difficult weather conditions(snow, rain, fog, etc.).	
Smartphone or tablet cannot be connected to the device	The device password has been changed.	Delete the network and reconnect using the device password
	The device is in an area with a large number of Wi-Fi networks that may cause interference.	To ensure stable Wi-Fi operation, relocate the device to an area with fewer Wi-Fi networks, or into an area with none.

Malfunction	Possible reason	Correction
Wi-Fi signal non existent or interrupted	The device is outside the area of Wi-Fi coverage. There are obstacles between the device and the receiver (e.g. concrete walls.)	Relocate the device into direct line of sight of the Wi-Fi signal.
When used in low-temperature conditions, the image quality of the surroundings is worse than in positive temperature conditions.	In positive temperature conditions, objects being observed (surroundings and background) heat up differently because of thermal conductivity, thereby generating a high-temperature contrast. Accordingly, the image quality produced by the device will be higher. In low-temperature conditions, objects being observed (background) do, as a rule, cool down to roughly the same temperature because of which temperature contrast is substantially reduced and the image quality (detail) is poorer. This is a feature of thermal imaging devices.	

IMPORTANT SAFETY INFORMATION

Environmental Influences

WARNING! Never point the lens of the device directly at intense heat sources such as the sun or laser equipment. The objective lens and eyepiece can function as a burning glass and damage the interior components. The warranty does not cover damage caused by improper operation.

Risk Of Swallowing

Caution: Do not place this device in the hands of small children. Incorrect handling can cause small parts to come loose which may be swallowed.

Safety Instructions For Use

- Handle the device and battery pack with care: rough handling may damage the battery pack.
- Do not expose the device to fire or high temperatures.
- Only use the battery charger included in the delivery package.
- The battery capacity decreases when operated in a cold ambient temperature. This is not a fault and occurs for technical reasons.
- Always store the device in its carrying bag in a dry, well-ventilated space. For prolonged storage, remove the batteries.
- Do not expose your device to extreme temperatures lower than -20°C and higher than $+50^{\circ}\text{C}$.
- The product shall only be connected to a USB Type C interface.
- If the device has been damaged or the battery is defective, send the device to our after-sales service for repair.

Safety Instructions For The Power Supply Unit

- Check the power supply unit, cable and adapter for visible damage before use.
- Do not use any defective parts. Defective components must be replaced.
- Do not use the power supply unit in wet or humid environments.
- Only use the original cable provided with the battery charger.
- Do not make any technical modifications.

For further information and safety instructions, please refer to the Operation Instructions provided. This is also available on our website in the download center: www.infrayoutdoor.com.

Disposal Of Batteries



In the European Union, this symbol indicates that the battery used in this product may not be disposed of in domestic waste and must be collected for disposal separately. When returning used batteries, please use a collection system that may exist in your country.

The materials and substances in the batteries may have a detrimental impact on health and the environment. By depositing empty batteries at a recycling facility, you are contributing to the protection, maintenance and improvement of the quality of our environment. Please only return discharged batteries. The battery used does not contain mercury, cadmium or lead in quantities exceeding the limits defined in Directive 2006/66/EC.

User information on the disposal of electrical and electronic devices (private households)



The WEEE symbol on products and/or accompanying documents indicates that used electrical and electronic products must not be mixed with ordinary household waste. For proper treatment, recovery and recycling, take these products to the appropriate collection points where they will be accepted without charge.

In some countries, it may also be possible to return these products to your local retailer when you purchase a corresponding new product. The proper disposal of this product serves to protect the environment and prevents possible harmful effects on human beings and their surroundings, which may arise as a result of incorrect handling of waste.

More detailed information on your nearest collection point is available from your local authority. In accordance with state legislation, penalties may be imposed for the improper disposal of this type of waste.

For business customers within the European Union

Please contact your dealer or supplier regarding the disposal of electrical and electronic devices. He will provide you with further information.

Information on disposal in other countries outside of the European Union

This symbol is only applicable in the European Union. Please contact your local authority or dealer if you wish to dispose of this product and ask for a disposal option.

Intended Use

The device is intended for displaying heat signatures during nature observation, remote hunting observations and for civil use. This device is not a toy for children.

Use the system only as described in this instruction manual. The manufacturer and the dealer accept no liability for damages which arise due to non-intended or incorrect use.

Function Test

- Before use, please ensure that your device has no visible damage.
- Test to see if the device displays a clear, undisturbed image.
- Check that the settings for the thermal imaging monocular are correct. See the notes in the section Operation.

Installing/Removing The Battery

The Finder II series thermal imaging monocular is equipped with a battery pack. The battery pack can be moved and charged, referring to the section Battery Pack for details.

Observation With And Without Glasses

Thanks to the flexible eyeshade, the Finder II series can be used with or without glasses. It offers a full field of view in both cases.

Legal and Regulatory Information

Wireless transmitter module frequency range:

WLAN: 2.412-2.472GHz (For EU)

Wireless transmitter module power<20dBm (only for EU)



IRay Technology Co., Ltd. thus declares that the Finder II series complies with the directives 2014/53/EU and 2011/65/EU. The full text of the EU declaration of conformity as well as additional information are available at: www.infirayoutdoor.com.

This device may be operated in all member states of the EU.

This equipment meets the government's requirements for exposure to radio waves. The guidelines are based on standards that were developed by independent scientific organizations through periodic and thorough evaluation of scientific studies. The standards include a substantial safety margin designed to assure the safety of all persons regardless of age or health.

The highest SAR value reported under this standard during product certification for use at the head is 0.005W/kg and when properly worn on the body is 0.016W/kg. This device was tested for typical body-worn operations with the back of the handset kept 0.5cm from the body.

Body Operation

This device was tested for typical body-support operations. To comply with RF exposure requirements, a minimum separation distance of 0.5cm must be maintained between the user's body and the handset, including the antenna. Third-party belt-clips, holsters, and similar accessories used by this device should not contain any metallic components. Body

accessories that do not meet these requirements may not comply with RF exposure requirements and should be avoided. Use only the supplied or an approved antenna.

FCC Statement

FCC-ID: 2AYGT-26X

Labeling Requirements

This device complies with part 15 of the FCC Rules. Operation is subject to the following two conditions: (1) This device may not cause harmful interference, and (2) this device must accept any interference received, including interference that may cause undesired operation.

Information To User

Any changes or modifications not expressly approved by the party responsible for compliance could void the user's authority to operate the equipment.

Note: The manufacturer is not responsible for any radio or TV interference caused by unauthorized modifications to this equipment. Such modifications could void the user's authority to operate the equipment.

Note: This equipment has been tested and found to comply with the limits for a Class A digital device, pursuant to part 15. These limits are designed to provide reasonable protection against harmful interference when the equipment is operated in a commercial environment. This equipment generates, uses, and can radiate radio frequency energy and, if not installed and used in accordance with the instruction manual, may cause harmful interference to radio communications. Operation of this equipment in a residential area is likely to cause harmful interference in which case the user will be required to correct the interference at his own expense.

This equipment meets the government's requirements for exposure to radio waves. The guidelines are based on standards that were developed by independent scientific organizations through periodic and thorough evaluation of scientific studies. The standards include a substantial safety margin designed to assure the safety of all persons regardless of age or health.

The highest SAR value reported under this standard during product certification for use at the head is 0.011W/kg and when properly worn on the body is 0.034W/kg. This device was tested for typical body-worn operations with the back of the handset kept 0.5cm from the body.

Body Operation

This device was tested for typical body-support operations. To comply with RF exposure requirements, a minimum separation distance of 0.5cm must be maintained between the user's body and the handset, including the antenna. Third-party belt-clips, holsters, and similar accessories used by this device should not contain any metallic components. Body accessories that do not meet these requirements may not comply with RF exposure requirements and should be avoided. Use only the supplied or an approved antenna.

We, IRay Technology Co., Ltd., hereby declare that this product was tested conforming to the applicable FCC rules under the most accurate measurement standards possible, and that all the necessary steps have been taken and are in force to assure that production units of the same equipment will continue to comply with the Commissions requirements.