



IRay Technology Co., Ltd.

Tel: 0086-400-999-3800

Email: infrared@infiRay.com

Web: www.infrared.com

Add.: 11th Guiyang Street, YEDA, Yantai 264006, P.R. China



Search InfiRay Outdoor



User Manual V1.0

GEMINI

Multi-spectral Thermal Imaging Binocular

IMPORTANT SAFETY INFORMATION

Environmental influences

WARNING! Never point the lens of the device directly at intense heat sources such as the sun or laser equipment. The objective lens and eyepiece can function as a burning glass and damage the interior components. The warranty does not cover damage caused by improper operation.

WARNING! Caution Use of controls or adjustments or performance of procedures other than those specified herein may result in hazardous radiation exposure.

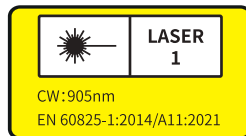

Ergonomics notes

Caution: Take breaks after longer periods of use to avoid wrist pain.

Risk of swallowing

Caution: Do not place this device in the hands of small children. Incorrect handling can cause small parts to come loose which may be swallowed.

Safety instructions for use

- Handle the device with care: rough handling may damage the internal battery.
- Do not expose the device to fire or high temperatures.
- Only use the battery charger included in the delivery package.
- The maximum operating temperature of the adapter is 25°C.
- The battery capacity decreases when operated in a cold ambient temperature. This is not a fault and occurs for technical reasons.
- The recommended temperature for using this product is -25° to +55°.
- Temperature exceeding this range will affect the service life of the product.
- Do not store the device for long periods at temperatures below 25°C or above 50°C, or this will permanently reduce the capacity of the battery.
- Always store the device in a dry, well-ventilated space.
- If the device has been damaged or the battery is defective, send the device to our after-sales service for repair.
- Before using this product in an environment with water, ensure that the USB-C connector is tightly covered.

Safety instructions for the power supply unit

- Check the power supply unit, cable and adapter for visible damage

before use.

- Do not use any defective parts. Defective components must be replaced.
- Do not use the power supply unit in wet or humid environments.
- Only use the original cable provided with the battery charger.
- Do not make any technical modifications.

For further information and safety instructions, please refer to the Operation Manual provided. This is also available on our website in the download center: www.infirayoutdoor.com.

User information on the disposal of electrical and electronic devices (private households)



The WEEE symbol on products and/or accompanying documents indicates that used electrical and electronic products must not be mixed with ordinary household waste. For proper treatment, recovery and recycling, take these products to the appropriate collection points where they will be accepted without charge. In some countries, it may also be possible to return these products to your local retailer when you purchase a corresponding new product. The proper disposal of this product serves to protect the environment and prevents possible harmful effects on human beings and their surroundings, which

may arise as a result of incorrect handling of waste.

More detailed information on your nearest collection point is available from your local authority. In accordance with state legislation, penalties may be imposed for the improper disposal of this type of waste.



2006/66/EC (battery directive): This product contains a battery that cannot be disposed of as unsorted municipal waste in the European Union. See the product documentation for specific battery information. The battery is marked with this symbol, which may include lettering to indicate cadmium (Cd), lead (Pb), or mercury (Hg). For proper recycling, return the battery to your supplier or to a designated collection point. For more information see: www.recyclethis.info.

For business customers within the European Union

Please contact your dealer or supplier regarding the disposal of electrical and electronic devices. He will provide you with further information.

Information on disposal in other countries outside of the European Union

This symbol is only applicable in the European Union. Please contact your local authority or dealer if you wish to dispose of this product and ask

for a disposal option.

Intended use

The device is intended for displaying heat signatures during nature observation, remote hunting observations and for civil use. This device is not a toy for children.

Use the device only as described in this operating manual. The manufacturer and the dealer accept no liability for damages which arise due to non-intended or incorrect use.

Function test

- Before use, please ensure that your device has no visible damage.
- Test to see if the device displays a clear, undisturbed image.
- Check that the settings for the device are correct. See the notes in the section Operation.

Observation with and without glasses

Thanks to the flexible eye-shade, the GEMINI series can be used with or without glasses. It offers a full field of view in both cases.

1 Specifications

Model	GEL35R	GEH50R
Thermal Imaging Specifications		
Resolution, pixel	384×288	640×512
Pixel Size, μm	12	12
NETD, mk	≤25	≤25
Frame Rate, Hz	50	50
Objective Lens, mm	35	50
Field of View, °	7.5×5.6	8.8×6.6
Optical Magnification, ×	4.8~19.2	4.1~16.4
Detection Distance (human 1.7x0.5)	1800	2600
Digital Night Vision Imaging Specifications		
Resolution, pixel	1920×1080	
Pixel Size, μm	4	
Frame Rate, Hz	50	
Objective Lens, mm	35	
Field of View, °	9.4×7.0	
Optical Magnification, ×	3.8~15.2	
Laser Rangefinder		
Max, Rangefinder Distance, m	1200	

Measuring Accuracy, m	±1(3-100m); ±(1+L×0.25%)(100-1200m,L is the distance to the target)
Eyepiece	
Focal Length of Eyepiece,mm	12.5
Magnification, ×	20
Eye Relief, mm	15
Eye Relief Diameter, mm	7
Diopter Adjustment, D	-5~+5
Available Pupillary Range, mm	61~72
Display	
Resolution,pixel	1024×768x2 OLED
Size,inch	0.39
Battery Specifications	
Battery Type/Capacity/Output Voltage	Two 18650 Lithium-ion batteries /3.2Ah/3.7V
Voltage	7.4
System Functions	
Digital Zoom, ×	1~4
Image Mode	Visible light, infrared (white hot, black hot, red hot, iron), fusion
Intelligent Image Algorithm	Infrared highlight, Infrared edging, hotspot tracking
PIP	√

Full color fusion	√
Image Capture and Video/Audio Recording	√
Video Playback	√
Wi-Fi Transmission (ios & android)	√
Electronic compass	√
Microphone	√
940nm Infrared Flashlight	√
Type-C interface	Power supply, data export, firmware update

Other Specifications

IP Rate	IP66	
Memory, GB	32GB EMMC interface	64GB EMMC interface
Operating Temperature, °C	-25~+55	
Weight (no battery), g	<900	<960
Dimension, mm	198x154x78	
Operating Time, h	>6	

* Actual operating time will depend to what extent the Wi-Fi and built-in video recorder is used.

➤ Improvements may be made to the design and software of this product to enhance its features without prior notice to the customer.

2 Package Contents

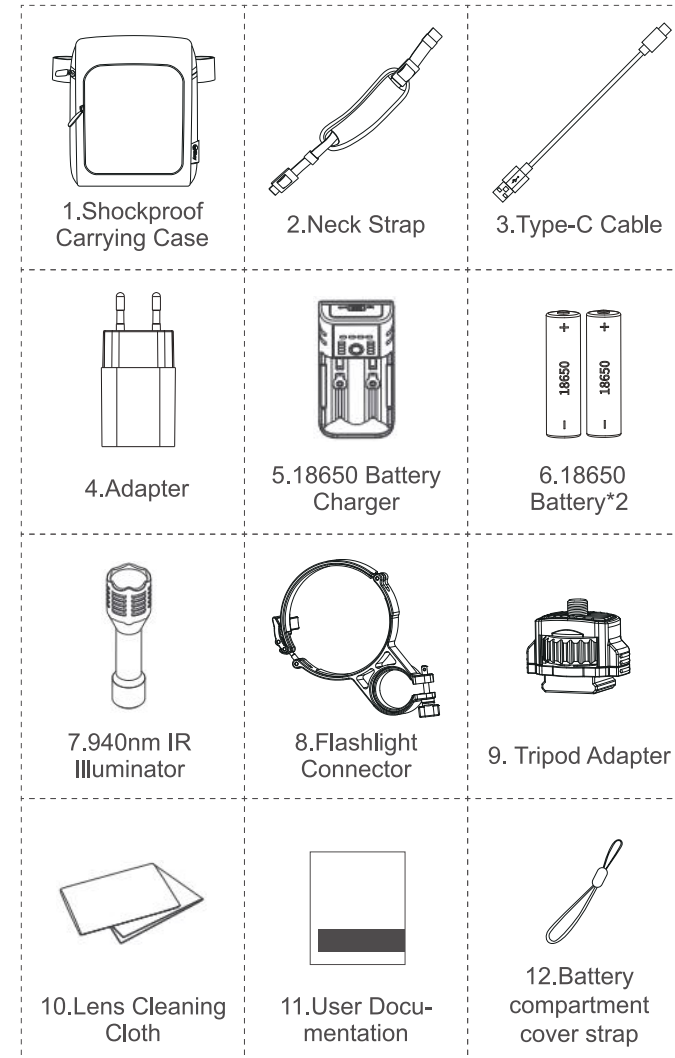

3 Product Overview

GEMINI series binocular have integrated high-sensitivity thermal imaging detector, laser range finding, Wi-Fi, DMC, microphone and 1024×768 OLED. The 1920×1080 visible light Min. illumination detectors are available for some models. It is ultra-light in body, plug-and-play, smart and simple and can bring you excellent holding experience. The binocular can be used for 24/7 observation, it is suitable for scenarios such as police and law enforcement, mountain forest protection, geological prospecting, wilderness security protection, etc.

4 Main Functions

- Image capture, recording, and video playback
- Wi-Fi image transmission
- PIP, Hotspot Tracking , Fusion, Infrared highlight, Infrared edging
- DMC
- Laser range finding from 3m to 1200m
- Adjust interpupillary distance between 61mm and 72mm, and ±5D diopter
- Mobile APP interconnection
- Type-C power supply, data export, firmware update
- Support multi languages such as English, German, Russian, French, Spanish, Portuguese, Italian, Czech, Polish, Hungarian, Dutch, Norwegian, Swedish, Slovak

5 Product Appearance

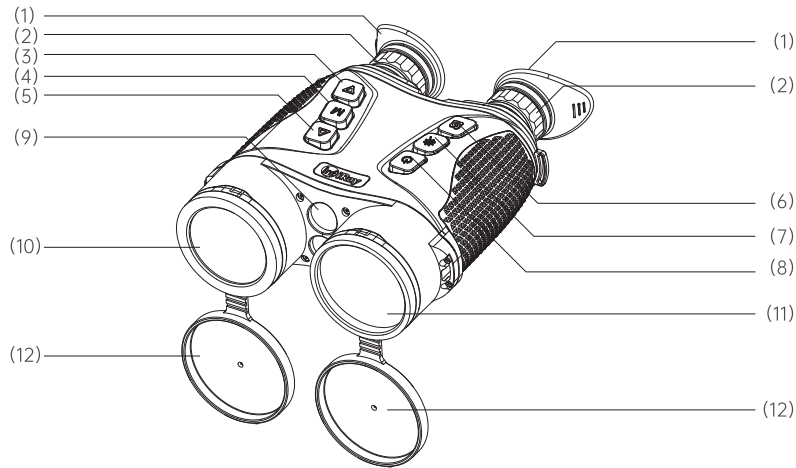

Figure 1 Front View

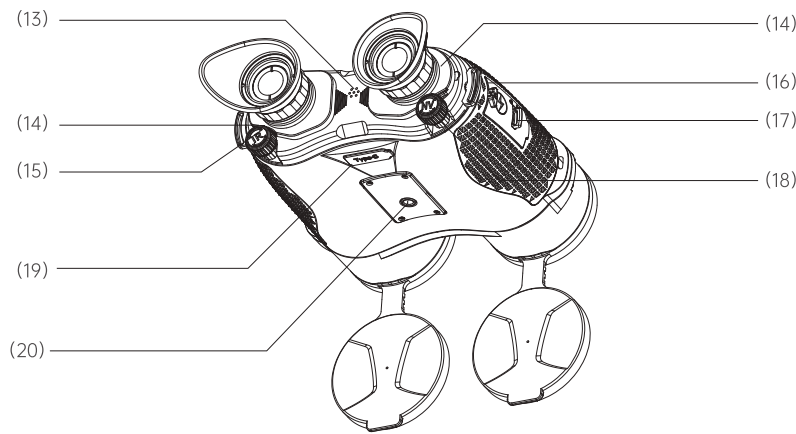

Figure 2 Rear View





- (1) Eye cup
- (2) Eyepiece
- (3) Down Button
- (4) Menu Button
- (5) Up Button
- (6) Camera Button
- (7) Range finding Button
- (8) Power Button
- (9) Laser Range Finding Window
- (10) Digital night vision Lens
- (11) Infrared lens
- (12) Lens Cap
- (13) Microphone
- (14) Interpupillary Distance Adjustment
- (15) Infrared Focus Ring
- (16) Neck strap buckle
- (17) Battery Compartment
- (18) Digital night vision Focus Ring
- (19) Type-C Interface
- (20) Tripod Interface

1. Focus ring: After the device is turned on, align at the observation target. When the distance of the observation target changes, the image may be blurred. At this time, you need to turn the focus ring to focus again until the image is clear.

2. Lens cap: When the device is not in use, you need to cover the lens cap to protect the lens.

3. Type-C data cable: This data cable supports power supply, data export, firmware update.

6 Button Descriptions

Button	Operation	Functions
Power Button 	Short press	No menu: Standby/Wakeup With menu: exit/return
	Hold for 1.5s	Power on/off
Range Finding Button 	Short press	Single range finding
	Long press	Start/ End continuous range finding
Camera Button 	Short press	Image capture
	Long press	Start/stop video recording
Up Button 	Short press	No menu: E-zoom cycles through 1×~4×, step 1×
		With menu: move upwards/toggle parameters
	Long press	No menu: PIP Mode cycles through Off,IR,NV and Fusion
		With menu: the option is shifted left in time/ magnetic declination settings interface
Menu Button M	Short press	No menu: enter the shortcut menu
		With menu: enter the next menu or confirm/cancel
	Long press	No menu: enter the system menu
		With menu: exit the shortcut/system menu
Down Button 	Short press	No menu: Image Mode cycles through NV, IR and Fusion
		With menu: move downwards/ toggle parameters
	Long press	No menu: Color Palettes cycle through WhiteHot,BlackHot, RedHot and Iron
		With menu: the option is shifted right in time/ magnetic declination settings interface
Up Button+Menu Button	Short press	Shutter correction
	Long press	Background correction
Down Button+Menu Button	Short press	Switch between Day and Night in visual scenarios
	Long press	Switch among General, Highlight and Edging in Infrared scenarios
Up Button+Down Button	Short press	No menu: enter fusion settings interface
	Long press	Zero declination angles of the DMC Settings

7 Types of Power Supply

- **Type 1:** Insert two 18650 batteries into the binocular following the below illustration, pay attention to the polarity.

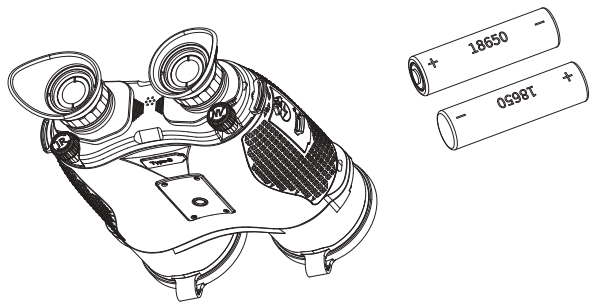

Figure 3 Types of Power Supply

- **Type 2:** Connect one end of the Type-C cable (20) to the Type-C connector(19) on the binocular, connect the other end of the Type-C cable (20) to the power adapter (21). Insert the adapter plug (21) into the 110-240V socket (22).

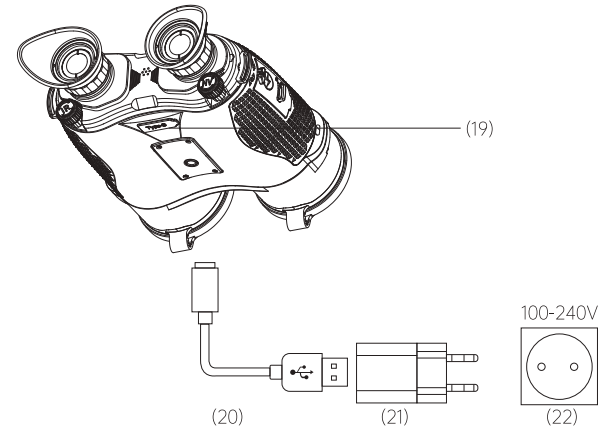

Figure 4 Power supply via Type-C Cable

- The nominal voltage and current is 7.4V/0.4A with battery as power supply, and the nominal voltage and current is 5V/0.6A when powered via Type-C cable.
- During use, the power is low if the battery icon turns red. Please replace the battery or power the device using a Type-C cable to avoid data loss.
- Never use a damaged or modified charger.
- Don't leave battery unattended when charging.
- Do not expose the battery to high temperature or to a naked flame.
- Do not remove the battery when the binocular is on.
- Avoid using the battery at the temperature above the temperature shown in the table, this may decrease the battery's life.
- Store the device in a dry and ventilated environment.
- Keep the battery out of the reach of children.

8 Mounting of IR Illuminator

The IR illuminator with wavelength of 850nm or 940nm can be mounted on the binocular in lowlight conditions and in the darkness.

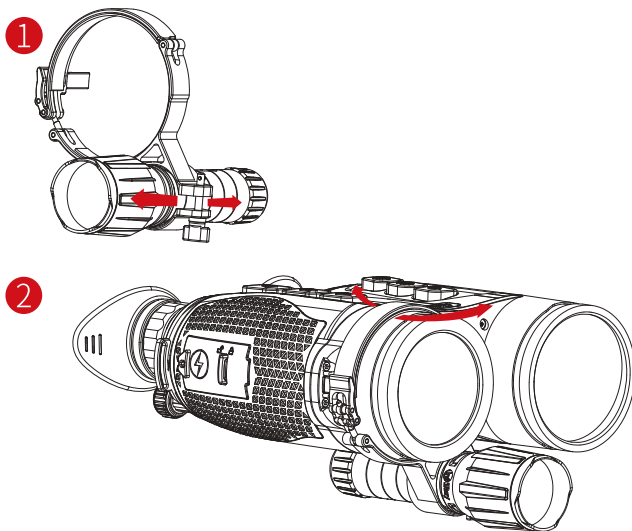

Figure 5 IR Illuminator Mounting Illustrations

9 Quick Start Guide

- **Power device on:** Long press the power button (8) for 1.5 secs, the starting logo will be displayed on the screen after 1 second.



Figure 6 Start-up Interface

- When an infrared image is displayed in the eyepiece, the binocular enters the operating status.
- Rotate the diopter adjustment knob (2) to adjust the resolution of the icon on the display. The diopter adjustment knob is used to adjust the eyepiece diopter for users with different degrees of myopia.

- **Quick Menu:** On the home screen, short press the menu button (4) to open quick menu, then the WiFi, DMC, Microphone, Hotspot Tracking and IR Enhance can be set. Short press Up button (5)/Down button (3) to toggle among the different function options and short press the menu button (4) to switch parameters, short press the power button (8) to exit/back to the previous level.
- **System Menu:** On the home screen, long press the menu button (4) to enter the system menu interface to get more functions. Short press the Up button (5)/Down button (3) to toggle among different function options, short press the Menu button (4) to switch parameters, then short press the power button (8) to exit/back to the previous level.
- **Image Capture/Video Recording:** On the home screen, short press the Camera button (6) to start/end image capture. Then long press the Camera button (6) to record videos.
- **Laser Range Finding:** Short press the LRF Button (7) to perform single range finding; Long press the LRF button (7) to perform continuous range finding.
- **Power Device Off:** Long press the power button (8) for 3 secs, the shutdown interface will be displayed in 3 secs. Release the power

button (8) to cancel during shutdown count down.

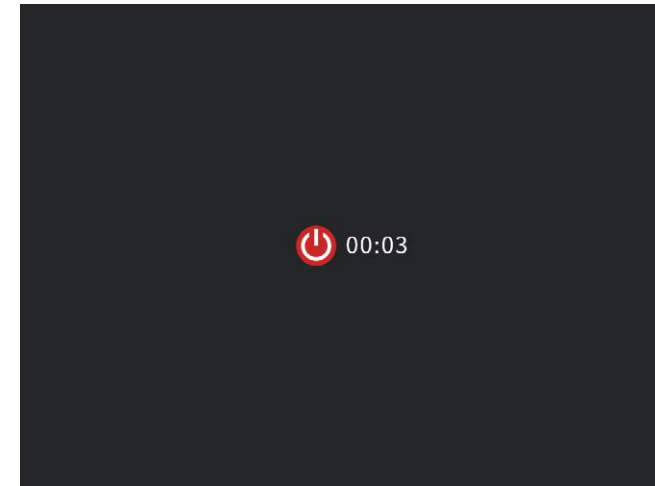

Figure 7 Shutdown Interface

- **Standby:** On the home screen, short press the power button (8) to enable standby mode. Short press the power button (8) again to wake up the device. The device will shut down after standby for 30min.



10 Status Bar



Figure 9 Main Interface

1. Time and date: display the current time and date. It can be modified in System Menu → System Settings → Time Settings.
2. Image Mode: short press the Down button (3) to switch among White-hot, Blackhot, Redhot and Iron.
3. Infrared Polarity: long press the Down button (3) to switch among visible light (NV), Infrared (IR) and Fusion (FU).

4. Image Scenarios: In NV Mode, short press the Down button (3) + Menu button (4), switch between Day (☀️) and Night (🌙). In IR Mode, long press the Down button (3) + Menu button (4), switch among General (🌐), Highlight (👉), Edging (👤).
5. Electronic zoom: short press the up button (5), electronic zoom +/-, step size is 0.1x, the image can be reduced/enlarged by 1x~4x at the center of the display; long press the up button (5), electronic zoom +/-, step size is 1x.
6. Laser Range Finding: short press the LRF button (7), for single range finding (🔴); Long press the LRF button (7) for continuous range finding (🔴);
7. Storage capacity: when the remaining storage capacity is less than 100M, this icon will be displayed.
8. Microphone: set through Shortcut Menu → Startup. When microphone is enabled, the icon will be displayed.
9. Wi-Fi image transmission: set through Shortcut Menu → Startup. When Wi-Fi is enabled, the icon will be displayed.
10. Type-C: when Type-C cable is connected, the icon will be displayed: display (🔌).

11. Battery level: real-time battery level display, display  when the battery level is low, display  when no battery is inserted.

12. Azimuth: display the current azimuth information in real time. When it is used for the first time or the location is changed, it can be calibrated through System Menu→Location→DMC.

13. Pitch angle: display the current pitch angle information in real time. You can calibrate it through System Menu→Location→DMC when it is used for the first time or the location is changed.

14. Tilt angle: display the current tilt angle information in real time, and it can be calibrated through System Menu→Location→DMC when it is used for the first time or the location is changed.

15. Range finding distance: short press the range finding button to display the range finding distance in real time.

11 Image Calibration

When the image is degraded or non-uniform, it can be improved by calibration. Calibration can equalize the background temperature of the detector and eliminate the image defects (such as vertical stripes, phantom images, etc.). There are two calibration modes - Shutter Calibration and Background Calibration.

- **Shutter Calibration:** Short press the Up button (5) + Menu button (4), the device will perform shutter calibration based on the software algorithm, it's unnecessary to close the lens

cap (the internal shutter blocks the sensor) for shutter calibration. The shutter calibration type can be set in the system menu. Refer to the System Menu-System Settings-Shutter Calibration Section.

- **Background Calibration:** Short press the Up button (5) + Menu button (4), if the thermal image is not satisfying even after shutter calibration, you can try to close the infrared lens cap and click Yes to perform background calibration. As shown in the following figure:

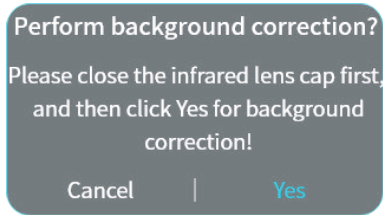

Figure 10 Background Calibration Interface

12 Photography and Video Recording

GEMINI series is equipped with a function for video recording and photography of the observed image which is saved on the built-in 64GB memory storage. The photo and video files are named with time, so it is suggested to synchronize date and time in the **InfiRay Outdoor** application before using the photo and video functions, or you can synchronize Date & Time in System

Menu-Time-Satellite Time/Time Settings.

Photography

- On the home screen, short press the Camera button (6) to capture an image.
- When taking a photo, the photo icon flashes below the status bar in the upper left corner of the screen. The photo is taken successfully when the thumbnail

appears on the bottom right corner of the screen.

- Photos are stored in the built-in storage.
- When “the memory space is insufficient” box is prompted on the interface, check and transfer videos and images to other media to free up the space.



Figure 11 Image Capture

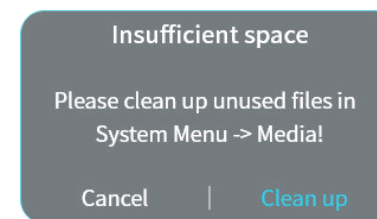

Figure 12 Insufficient Space

Video Recording

- On the home screen, long press the Camera button (3) to start the video recording function.
- Then, the recording timer in the format of the HH: MM: SS (hour: minute: second) will appear on the upper left of the display.
- The other operations to the device are supported during recording.
- Long press the Camera button (6) again to stop and save the video recording.
- All videos and photos will be saved in the build-in storage.



Figure 13 Video Recording

13 Digital Zoom

- GEMINI series support to cycle switch digital zoom from 1× to 4× by short pressing the Up button (5), in 1× increment.
- The corresponding magnification is displayed in the status bar, as shown in the following figure:



Figure 14 Digital Zoom Interface

14 Fusion Settings

- Short press the Up button (5) + Down button (3) to enter fusion settings interface. As shown in the following figure:



Figure 15 Fusion Settings Interface

- Short press the menu button (4) to switch X/Y coordinate; Short press the Up button (5) to move the visual image leftward/upward by one step; Short press the Down button (3) to move the

visual image rightward/down-

- ward by one step.
- Short press the Power button (8) to exit, the parameters won't be saved; Short press the Up button (5)+Down button (3), a prompt box will pop up: Save this operation? As is shown in the following figure:

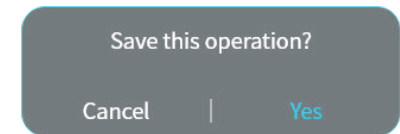

Figure 16 Fusion Saving Prompt

- Short press the Menu button (4) to cancel/confirm this operation.

15 DMC Zero Declination Angle Settings

During the installation or transportation of the DMC, there may be a slight deviation, resulting in a slight deviation in the DMC information. In this case, it can be addressed by setting zero declination angles of the DMC.

- Long press the Up button (5) + Down button (3) to enter the DMC Zero Declination Angle Settings interface. As shown in the following figure:

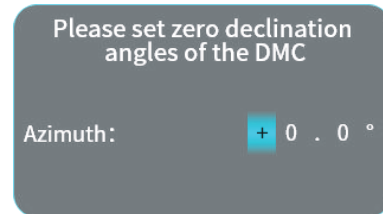

Figure 17 DMC Zero Declination Angle Settings Interface

- Short press the Power button (8) to exit directly without saving the parameters; Short press the Menu button (4) to save the parameters and exit.

16 Quick Menu Functions

- On the Home Screen, short press the Menu button (4) to enter the quick menu.
- Short press the Up button (5) /Down button (3) to toggle between functions, then press the Menu button (4) to confirm.
- Short press the Power button (8) to exit /back to the previous level, press and hold the Menu button (4) to hide the quick menu.



Figure 18 Shortcut Menu

1. WiFi: short press the Menu button (4) to enable WiFi, disabled by default.
2. DMC: short press the Menu button (4) to enable DMC, disabled by default.
3. Microphone: short press the Menu button (4) to enable Microphone, disabled by default.

4.Hotspot Tracking: short press the menu button (4) to enable hotspot tracking, which will make real-time track on the hottest object on the screen mark with a 32*32 red box, disabled by default. As shown in the following figure when it is enabled.



Figure 19 Hotspot Tracking

5.IR Enhance: short press the Menu button (4) to enable IR Enhance to present more details, disabled by default.

17 System Menu Functions

- On the Home Screen, long press the Menu button (4) to enter the system menu.
- Press the Up button (5)/Down button (3) to toggle between functions, then press the Menu button (4) to select the option, press the UP button (5)/Down button (3) to switch parameters.
- Press the Power button (8) to exit back to the previous level, press and hold the menu button (4) to hide the system menu.

Display Settings



Figure 20 Display Menu

- 1.Screen Brightness: real-time adjustment on screen brightness adjustment, adjustment range 1-5, 3 by default.
- 2.Image Brightness: real-time adjustment on IR/NV image brightness, adjustment range 1-5, 3 by default, supported in IR or NV mode.
- 3.Image Contrast: real-time

adjustment on IR/NV image contrast, adjustment range 1-5, 3 by default, supported in IR or NV mode.

4.Reticle: the reticle will be displayed on the screen center when it is enabled, enabled by default.

Media



Figure 21 Media Menu

1.File Browse

Short press the Menu button (4) and turn to media browse interface. As shown in the following figure:

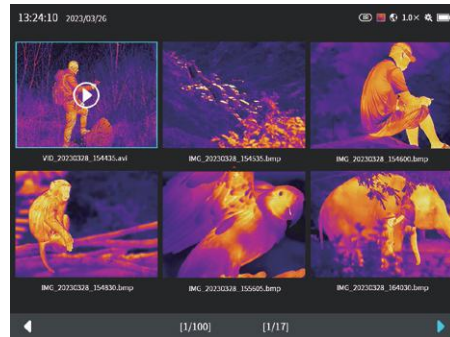

Figure 22 Image Selection Interface

>Image Browse

- Short press Up button(5)/ Down button (3), move to select images, then short press Menu button (3) to present Play / Delete option. As shown in the following figure:

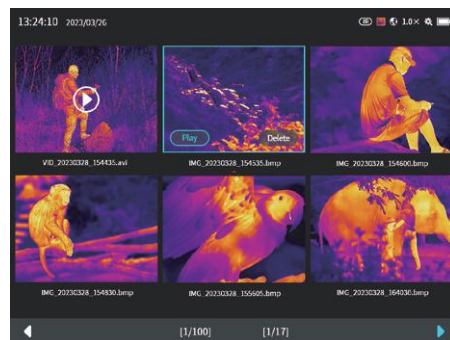

Figure 23 Image Selection Interface

- Short press Up button (5)/ Down button (3) to select Play, then short press menu button (3) to enter full-screen play interface. As shown in the following figure:

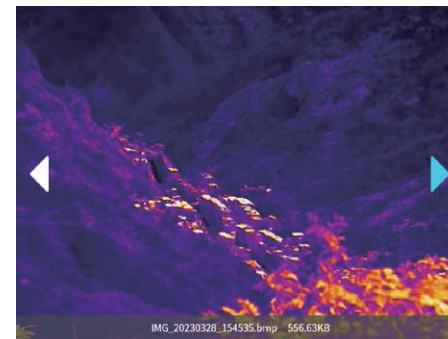

Figure 24 Image Play Interface

- On the play interface, short press Up button (5)/ Down button (3) to switch image/video, short press Power button (8) to return to the previous menu.

>Video Browse

- Short press Up button (5)/ Down button (3) to select the video, then short press Menu button (4) to present Play/Delete option. As shown in the following figure:

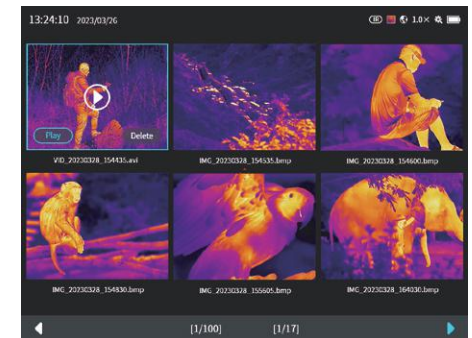

Figure 25 Video Selection Interface

- Press Up button (5)/ Down button (3) to select Play, continue to short press Menu button (4) to enter full-screen play interface. As shown in the following figure:



Figure 26 Video Play Interface

- Short press the Menu button (4) to pause on the full-screen play interface. As shown in the following figure:



Figure 27 Video Pause Interface

- On video play interface, short press up button (5)/down button

(3) to switch image/video, short press power button (8) to return to the previous menu.

Image/Video Deletion

- On the media interface and full-screen image/video play interface, long press menu button (4) to present Delete interface. As shown in the following figure:

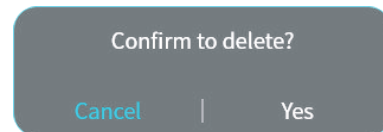

Figure 28 Image/Video Delete Interface

- If the media file is empty, the prompt is as shown in the following figure:



Figure 29 Image/Video Delete Interface

2. Waterproof Overlay: When this function is enabled, date, DMC, and ranging distance information will be displayed on local recorded videos, captured images and Wi-Fi transmission.

Location Settings

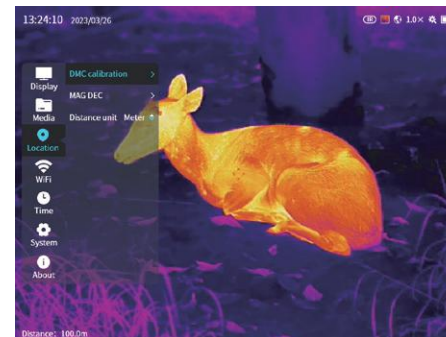

Figure 30 Location Settings Menu

1. The built-in azimuth module should be calibrated if the binocular is transported from the manufacturing place to different places of use due to the influence of magnetic field and gravity. The calibration

procedures are as shown in the following figure:

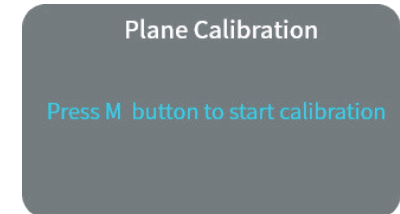

Figure 31 Calibration Step 1

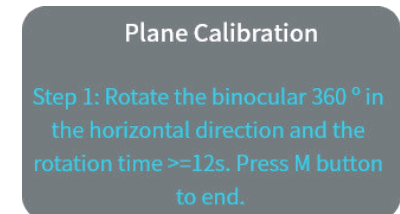

Figure 32 Calibration Step 2

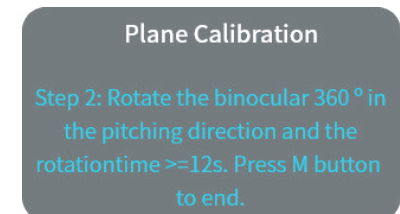

Figure 33 Calibration Step 3



Figure 34 Calibration Step 4

2. Magnetic Declination: the magnetic declination parameters can be

set, as shown in the following figure:

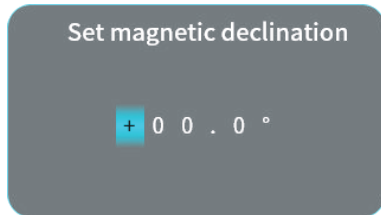

Figure 35 Magnetic Declination Settings

- 3. Altitude Unit: Meter/Foot, meter by default.
- 4. Range-finding Unit: Meter/Foot, meter by default.

Wi-Fi Settings



Figure 36 Wi-Fi Settings Menu

1. Wi-Fi Name: can be viewed only, the name can be set via App,

setting range is 1-32 characters, the initial name is GEMINI_ the latter six characters of Mac, for example: GEMINI_78C132.

- 2. Encryption Type: None/WPA2, WPA2 by default.
- 3. Password: can be viewed only, the password can be set via App, setting range is 8-16 characters, the initial password is 12345678.

Time Settings

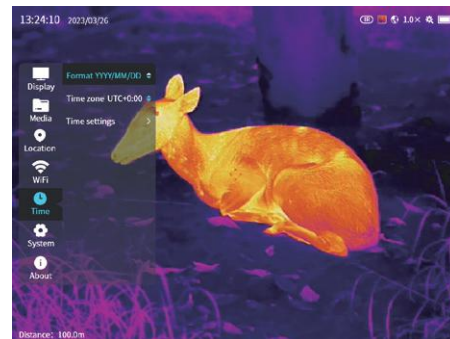

Figure 37 Time Settings Menu

1. Date format: Y/M/D, D/M/Y or M/D/Y. Y/M/D by default.

- 2. Time zone settings: time zone can be set, local time zone is displayed by default.
- 3. Time settings: it can be used when the satellite time is disabled, the setting parameters are as shown in the following figure:

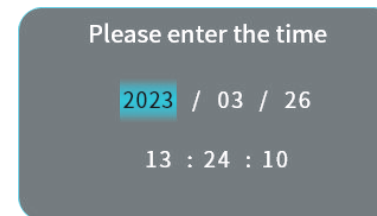

Figure 38 Time Settings Interface

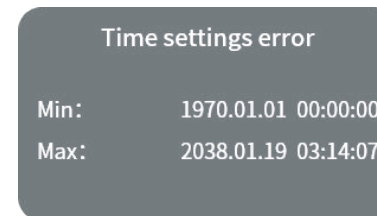

Figure 39 Time Settings Error Interface

System Settings



Figure 40 System Settings Menu

- 1. Language: English / German / Russian / French / Spanish / Portuguese / Italian / Czech / Polish / Hungarian / Dutch / Norwegian / Swedish / Slovak, English by default.
- 2. Volume: adjustment range is 1-5, 3 by default.
- 3. Format: the image and video data will be deleted and cannot be recovered after formatting, so please backup first. As shown in the

following figure: will be deleted and cannot be recovered after restoring system, all the parameters will restore to factory default settings, so please backup first.As shown in the following figure:

4.Restore system: the image and video data will be deleted and cannot be recovered after restoring system, all the parameters will restore to factory default settings, so please backup first.As shown in the following figure:

cannot be recovered after restoring system, all the parameters will restore to factory default settings, so please backup first.As shown in the following figure:

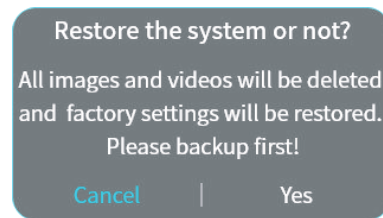

Figure 43 Restore System Interface



Figure 44 System Recovery Success

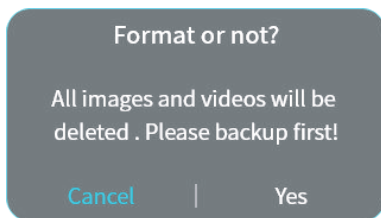

Figure 41 Format Interface



Figure 42 Format Succeed

4.Restore system: the image and video data will be deleted and

5.Shutter CORR:
Auto/Manual,Auto by default.

About



Figure 45 About Menu

1.Storage info: total capacity, used capacity and remaining capacity are displayed on storage info. As shown in the following figure:

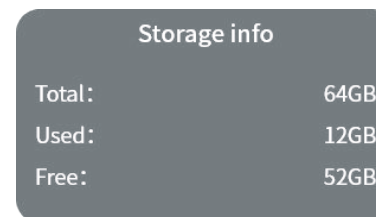

Figure 46 Storage Info

2. System information: The MODEL, device PN (DEV_PN), device SN (DEV_SN), infrared module

PN (CORE_PN), infrared module SN (CORE_SN), ARM version, algorithm (ALG) version, LOGIC version, NIOS version, and MAC address are displayed on system info. As shown in the following figure:

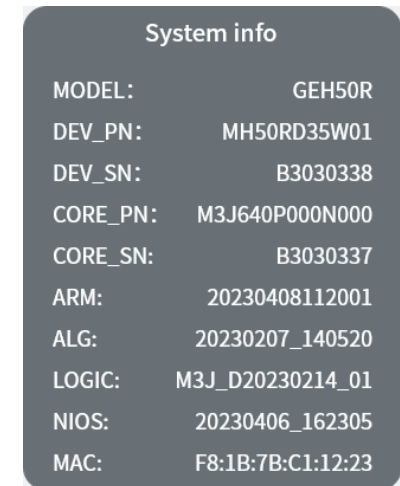

Figure 47 System Info

18 Wi-Fi Function

The GEMINI series can be can connect with the mobile device (laptop or mobile phone) for data transmission via Wi-Fi function.

- Turn Wi-Fi on in the quick menu. (For more information, please refer to Quick Menu-Enabled Items-Wi-Fi).
- After the Wi-Fi function is on, search for the Wi-Fi signal with the name "GEMINI_XXXXXX" on the mobile device, XXXXXX is the last 6 digits of the device MAC address.
- Select the Wi-Fi and enter the password to connect. The initial password is 12345678.
- When Wi-Fi is successfully connected, it supports to control the device via the InfiRay Outdoor App downloaded in the mobile device.

Setting Wi-Fi Name and Password

The name and password of the Wi-Fi in GEMINI series can reset on the InfiRay Outdoor App.

- After the device is connected to the mobile device, locate and click the 'Settings' icon  on the InfiRay Outdoor image screen to enter the

Settings interface.

- In the text box, enter and submit the new Wi-Fi name (SSID) and password.
- It needs to reboot the device to take the new name and password effect.

Note: If the device is reset to the factory settings, the name and password of the Wi-Fi will also be restored to the default settings.

19 Firmware Update

- Notifications about updates will be posted on the official website or social media or InfiRay Outdoor APP.
- Connect the PC to the device via Type-C cable, and open the USB flash drive on the PC.
- Download the update file in the official website (www.infirayoutdoor.com) and store it to the folder named "update" in the memory space of GEMINI.
- Long press the Power button (7) to reboot the device;
- The device will automatically search for the update file stored in the folder named "update" in the memory space of GEMINI.
- Please make sure the device is fully charged before updating.

20 InfiRay Outdoor

- GEMINI series thermal imaging binocular support InfiRay Outdoor Technology, which allows you to transmit the image from the binocular to smartphone or tablet via Wi-Fi in real time mode.
- You can find the detailed instruction about InfiRay Outdoor at the site www.infirayoutdoor.com.
- Download and install the InfiRay Outdoor at the official website (www.infirayoutdoor.com) or app store or scanning the QR code below.



21 Technical Inspection

It is recommended to carry out a technical inspection each time before using the binocular. Check the following:

- The appearance (there should be no cracks on the body).
- The condition of the object lens and eyepiece (there should be no cracks, greasy spots, dirt or other deposits).
- The battery status (it should be charged).
- The controller/button should be in working order.

22 Maintenance

The maintenance should be carried out at least twice a year and includes the following steps:

- Wipe the surface of metal and plastic parts to clear off dust and dirt with a cotton cloth. Silicone grease may be used for cleaning process.
- Clean the electric contacts and battery slots on the device using a non-greasy organic solvent.

- Check the glass surface of the eyepiece and lens. If necessary, clear off the dust and sand on the lens (it is perfect to use a non-contact method).

Use a specialized wiping tool and solvent to clean the optical surfaces.

23 Legal and Regulatory Information

Wireless transmitter module frequency range:

WLAN: 2.412-2.472GHz (For EU)

Wireless transmitter module power < 20dBm (only for EU)

 IRay Technology Co., Ltd. thus declares that the GEMINI multi-spectral thermal imaging binocular complies with the directives 2014/53/EU and 2011/65/EU. The full text of the EU declaration of conformity as well as additional information are available at: www.infirayoutdoor.com.

This device may be operated in all member states of the EU.

Body-worn Operation

This device was tested for typical body-support operations. To comply with RF exposure requirements, a minimum separation distance of 0.5cm must be maintained between the user's body and the handset, including the antenna. Third-party belt-clips, holsters, and similar accessories used by this device should not contain any metallic components. Body accessories that do not meet these requirements may not comply with RF exposure requirements and should be avoided. Use only the supplied or an approved antenna.