

MATE

Thermal Imaging Attachment



User Manual

MAH50R

V1.0

IMPORTANT SAFETY INFORMATION

Environmental influences

WARNING! Never point the lens of the device directly at intense heat sources such as the sun or laser equipment. The objective lens and eyepiece can function as a burning glass and damage the interior components.

Risk of swallowing

Caution: Do not place this device in the hands of small children. Incorrect handling can cause small parts to come loose which may be swallowed.

Safety instructions for use

- Handle the device with care: rough handling may damage the internal battery.
- Do not expose the device to fire or high temperatures.
- Do not disassemble the device to access the battery. The battery is not meant to be replaced by the end user.
- The battery capacity decreases when operated in a cold ambient

temperature. This is not a fault and occurs for technical reasons.

- The recommended temperature for using this product is -20° to +50°. Otherwise, it will affect the service life of the product.
- Do not store the device for long periods at temperatures below -20°C or above 50°C, or this will permanently reduce the capacity of the battery.
- Always store the device in a dry, well-ventilated space.
- If the device has been damaged or the battery is defective, send the device to our after-sales service for repair.
- Before using this product in an environment with water, ensure that the Type C cover is tightly covered.

Safety instructions for the power supply unit

- Check the power supply unit, cable and adapter for visible damage before use.
- Do not use any defective parts. Defective components must be replaced.
- Do not use the power supply unit in wet or humid environments.
- Only charge the device at temperatures ranging between 0°C and 50°C.

- Do not make any technical modifications.

For further information and safety instructions, please refer to the User Manual provided. This is also available on our website in the download center: www.infirayouordoor.com.

Disposal of batteries



Directive 2006/66/EC (battery directive): This product contains a battery that cannot be disposed of as unsorted municipal waste in the European Union. For battery details, refer to the documentation of the specific product. The battery is marked with this symbol, which may include Cd (indicating cadmium), Pb (indicating lead), or Hg (indicating mercury). For proper recycling, please return the battery to your supplier or send it to a designated collection point. For more information, visit www.recyclethis.info.

User information on the disposal of electrical and electronic devices (private households)



2012/19/EU (WEEE directive): Products marked with this symbol cannot be disposed of as unsorted municipal waste in the European Union. For proper recycling, please return this product to your local supplier when purchasing a new equivalent product, or send it to a designated collection point.

For more information, visit www.recyclethis.info.

For business customers within the European Union

Please contact your dealer or supplier regarding the disposal of electrical and electronic devices. He will provide you with further information.

Information on disposal in other countries outside of the European Union

This symbol is only applicable in the European Union. Please contact your local authority or dealer if you wish to dispose of this product and ask for a disposal option.

Intended use

The device is intended for displaying heat signatures during nature

observation, remote hunting observations and for civil use. This device is not a toy for children.

Use the device only as described in this instruction manual. The manufacturer and the dealer accept no liability for damages which arise due to non-intended or incorrect use.

Function test

- Before use, please ensure that your device has no visible damage.
- Test to see if the device displays a clear, undisturbed image.
- Check that the settings for the thermal imaging camera are correct.

See the notes in the section Operation.

Installing/removing the battery

The MATE series thermal imaging attachment is equipped with a battery pack. It cannot be removed.

1 Specifications

Specs	MAH50R
Detector Specifications	
Resolution, pixels	640 × 512
Pixel size, um	12
NETD, mk	≤ 18
Frame rate, Hz	50
Optics Specifications	
Objective lens, mm	50
Field of view (H x V), degrees	8.8 × 7.0
Field of view (H x V), m @ 100 m	15.4 × 12.3
Magnification, X	Attachment mode: ×1 Monocular mode: ×1/×2/×4
Detection range, m (Target size: 1.7m×0.5m, P(n)=99%)	2600
Display Specifications	
Type	AMOLED
Resolution, pixels	1024 × 768
Batteru Power Supply	

Battery	Built-in battery + IBP-6 InfiRay battery Pack x 2
Max. operating time(22°C), h	4 + 2.5*2
External power supply	5V (Type-C)
Physic Specifications	
Wi-Fi/APP	Support (InfiRay outdoor)
Photo/video recorder	Support
MIC	Support
Memory capacity, GB	32
IP Rating	IP67
Operating temperature, °C	-20~+50
Weight, g	560
Dimension, mm	146 × 75 × 73
Connections and Compatibilities	
Max. recoil power on rifled weapon (Eo), Joules	6000
Recommended magnification of the day scope, x	G1/G2: 1X- 5X G3/G4: 6X – 10X
Click value@100m, cm	1.6
Adapter ring	M52 adapter

Connections and Compatibilities

Laser rangefinder	Support, 1200m
Ballistic calculation	Support

* The actual operating time depends on the intensity of using Wi-Fi, video recorder, laser rangefinder.

- Improvements may be made to the design and software of this product to enhance its useful features. Technical parameters of the device may be improved without prior notice of the customer.

2 Package Contents

- MATE Series Thermal Imaging Attachment
- Clip-on universal adapter*
- IBP-6 InfiRay battery pack * 2
- Power adapter
- Type C cable
- Side-entry picatinny rail
- Remote control base and bandage

- Remote control cover
- Heated target for zeroing (x10)
- Lens cloth
- Quick start guide

3 Description

MATE series are all-new generation front attachment designed as the infrared expansion device of the day light optics.

Different from the night vision device based on image enhancement, MATE doesn't need external light source and isn't influenced by strong light exposure. It can be used in the night or bad weather conditions such as fog, rain, smog and can detect the objects through obstacles such as branch, tall grass, dense bushes and so on. MATE has a wide range application including night hunting, observation and terrain orientation, search and rescue operations.

Using the MATE Series Front Attachment includes several benefits over night hunting with traditional optics or even the night vision devices.

Attaching the MATE Series to a traditional scope delivers the same creature comforts of shooting with day optics you are accustomed to, including your existing reticle and eye relief. The MATE Series Front Attachment even allows you to continue utilizing your riflescope's variable magnification

4 Features

- Built in LRF, 1200m
 - Ballistic calculation
 - Built-inQuick “monocular-attachment” conversion
 - Quick mounting and removal of attachment
 - 12µm thermal imaging detector
 - 1024×768 high resolution AMOLED display
 - No re-zeroing required and quick attached
 - Magnesium alloy housing
 - Familiar precision
 - Photographing / Video recording
- Support APP connecting via Wi-Fi
 - Wireless remote control
 - Four image modes – White hot, Black hot, Red hot, Color
 - Three scene modes – Forest, Flatland, City
 - Monocular's digital zoom: ×1, ×2, ×4
 - Degree of protection IP67

5 Components and Controls

1. Eyepiece
2. Eyepiece bayonet-type ring
3. Down button
4. Menu (M) button
5. Camera button
6. Up button
7. Lens focus knob
8. Lens cover
9. Objective lens
10. Power button
11. Microphone
12. Type-C port
13. Bottom picatinny rail
14. Laser rangefinder









6 Guidelines For Operation

The MATE series has been designed for long-term use. To ensure sustainable performance, please adhere to the following:

- Before use make sure that you have mounted and adjusted the device according to the instructions of the section “**Operation**”.
- Store with the lens cap on in the carrying case.
- Switch off the device after use.
- **Attempts to disassemble or repair the device will void the warranty!**
- The device is designed for use in various operating temperatures. However, if it has been brought indoors from cold temperatures, do not turn it on for 2 to 3 hours. This will prevent external optical surfaces from condensation.
- To ensure reliable performance, it is recommended to carry out regular technical inspections of the unit.

7 Description of Controls

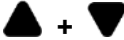
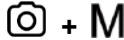
Button	Current Status	Short Press	Long Press
Power button 	Power off	---	Power on the device
	Home screen	Standby the device	Power off the device
	Standby	Wake up the device	
	Menu interface	Save and return to the upper interface	
Up button 	Home screen	Single range	Continuous range
	Menu interface	Scroll up options	---
	Zeroing / Pixels defect correction interface	Move one pixel to the Up every time	Move 10 pixels to the Up every time
Down button 	Home screen	Shutter correction	Background correction
	Menu interface	Scroll down options	---
	Zeroing / Pixels defect correction interface	Move one pixel to the Down every time	Move 10 pixels to the Down every time
Camera button 	Home screen	Take a picture	Video recording
	Zeroing / Pixels defect correction interface	Move one pixel to the Left every time	Move 10 pixels to the Left every time

Menu button M	Home screen	Enter shortcut menu interface	Enter Main Menu interface
	Menu interface	Adjust parameter	Save and exit to the home screen
	Zeroing / Pixel defect correction interface	Move one pixel to the Right every time	Move 10 pixels to the Right every time
Up + Down buttons 	Zeroing interface	---	Save and set the coordinate of the zeroing position as (0,0)
	Pixels defect correction interface	---	Add / Delete defect pixels
Camera + Menu buttons 	Zeroing interface / Pixels defect correction interface	---	Save and exit to the home screen
Down + Menu buttons 	Home screen	---	Switch between Attachment mode and Monocular mode

8 Installation

MATE series can be used as a monocular or front attachment for day light scope. Original design allows the monocular to be quickly converted into attachment and vice versa.

You can quickly switch the operation state of the MATE between the monocular mode and the attachment mode with a long press of the **Down (3) + Menu (4)** buttons for 3s.

As a front attachment

MATE as an attachment is designed to use a day light scope both in the nighttime and daytime in inclement weather (fog, smog, rain etc.).

When use as a front attachment, please ensure MATE is in attachment mode, in which the status bar at the top of the screen shows G1/G2/G3/G4.



To mount it on a day device, please follow instructions as follows:

- Please make sure that the day device is zeroed before installation.
- Measure the outer diameter of the lens of your day scope.
- According to the outer diameter of the objective lens of your day device, choose a suitable adapter (bought separately) with M52*0.75 internal thread.
- Screw the selected adapter onto the eyepiece of the MATE.
- Install firmly the adapter with MATE together onto the objective lens of your day device.
- Then you can use MATE as a front attachment.

As a monocular

- When used as a monocular, it needs to switch to the monocular mode, in which the status bar at the top of the screen shows x1/ x2/ x4.

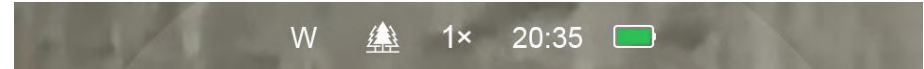

- For a better observation experience, the InfiRay Monocular **(15)** is suggested to use (bought separately from the InfiRay website).
- Screw the InfiRay Monocular **(15)** onto the eyepiece of the MATE.
- In monocular mode, the MATE supports up to 4x electronic zoom, and with the 4x24 InfiRay Monocular **(15)**, you will be able to obtain up to 16x amplification.



9 Operation

- Open the lens cover (8).
- Press and hold down the **Power (10)** button for 3s to power the device on. Wait for 5s until thermal image appears on the display.
- **Lens Focus Adjustment:** rotate the lens focus ring (7) to focus on the object being observed.
- **Calibration:**
 - **Shutter correction:** calibration the image with a short press of the **Down (3)** button for shutter correction
 - **Background correction:** long press the **Down (3)** button, the display will appear the prompt for “Cover lens during calibration” icon, then close the lens cover (8) to complete background correction.
- **Image settings:** short press the **Menu (4)** button to enter the Shortcut Menu interface, to set electronic zoom (only for Monocular mode) / image mode / Brightness / Scene mode / Sharpness level.
- **Power Off:** long press **Power (10)** button for 3s to power off the MATE.

- **Standby Mode:** Press the **Power (10)** button briefly to standby the device for power saving. And press the **Power (10)** button again to wake it up.

10 Zeroing (only for Attachment mode)

When MATE is installed on the day scope as an infrared extension component, if the reticle of the day scope is not in the center of the infrared image, the image zeroing function can be used to shift the infrared image to ensure the position consistency between the day scope image and the infrared image.

- Please finish the calibration of the day scope before mounting MATE.
- Install MATE on the day scope referring to the **Installation** section.
- Then aiming at the target at 100 meters and shoot. Measure the horizontal distance and vertical distance between the bullet hitting point and the aiming point afterwards.

- In the home screen, press and hold down **Menu (4)** button to enter the Main Menu interface.

- Press the **Up (6) / Down (3)** button to select the Zeroing Profile option () and select a zeroing profile with a short press of the **Menu (4)** button.

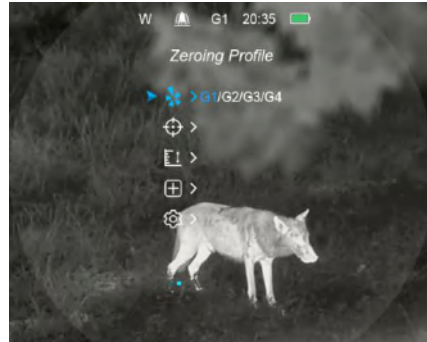

- Then select the Zeroing option () and short press the **Menu (4)** button to enter the Zeroing interface.



- In the zeroing interface, short or long press the **Up / Down / Camera / Menu** button briefly to move the position of infrared image until the target on the infrared image is consistency with the reticle center of the day scope.

- When the zeroing is done, long press **Menu (4) + Camera (5)** buttons to save and exit the zeroing interface, or hold down **Up (6) + Down (3)** buttons for 3s to save and set the coordinate of the zeroing position as

(0,0) and exit to the home screen.

11 Photography and Video recording

MATE series is built-in 32GB storage space for photography and video recording. The files of images and videos will be named by time, so it is recommended to set the time in the Main Menu or synchronize the time in the Settings of the InfiRay Outdoor APP before using the photography and video recording function.

Photography

- Press the **Camera (5)** button in the home screen to take a photo. The screen freezes for 0.5s, and a photo icon appears on the screen.
- Photographs are saved in a built-in storage space.
- When the exclamation mark icon () appears on the right side of the



camera icon, it prompts that the memory space is insufficient. Check and transfer videos and images to other media to free up the space.

Video recording

- In the home screen, press and hold down the **Camera (5)** button to start a video recording.
- A recording timer displays on the top of the screen. the time format is MM:SS (minute: second).
- During recording, it is still possible to take a photo with a short press of the **Camera (5)** button.
- Also, you can enter and navigate the menu function during video recording
- Press and hold down the **Camera (5)** button to stop and save the recording.
- The video and photo are saved in the built-in storage space.



Note

- You can open and operate the menu during video recording.
- The images taken and the videos recorded are stored in the built-in memory space in the format of PIC_HHMMSS.jpg (image) and VIDEO_HHMMSS.mp4 (video), with HHMMSS indicating hour/minute/second.
- The maximum duration of a video recording file is 30 minutes. When the duration is more than 30 minutes, the video will be automatically recorded onto a new file.
- The number of files is limited by the internal memory space of the device. Check the remaining space regularly, and transfer your videos and images to other media to free up the space on the memory card.

Memory Access

When the device is turned on and connected to a computer, it is recognized by the computer as a flash memory card, which is used to access the device's memory and make copies of pictures and videos.

- Turn on the riflescope and connect it with the computer via Type-C cable.

- Double click “my computer” on the desktop - double click to open the device named “InfiRay” - double click and open the device named ‘Internal Storage’ to access built-in memory.
- There are different folders named by time in the storage.
- Recorded photos and videos in that day are saved in the folders
- Select desired files or folders to copy or delete.

12 Shortcut Menu

- In the home screen, press the **Menu (4)** button briefly to enter the shortcut menu interface. The functions are as followings:

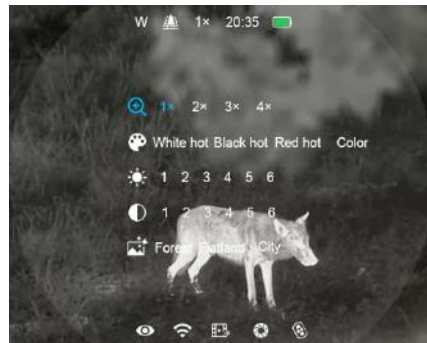

- **E-zoom (🔍 , only for Monocular mode)**: short press the **Menu (4) / Camera (5)** button to E-zoom the image from x1 to x4.
- **Image mode (🎮)** : short press the **Menu (4) / Camera (5)** button to switch the image mode from White hot、Black hot、Red

hot、Color.

- **Screen Brightness (☀️)**: short press the **Menu (4) / Camera (5)** button to switch the screen brightness from level 1 to level 6.
- **Image Contrast (🌓)**: short press the **Menu (4) / Camera (5)** button to switch the image contrast from level 1 to level 6.
- **Scene Mode (🌲)**: short press the **Menu (4) / Camera (5)** button to switch the scene mode among Forest, Flatland and City.
- Press the **Up (6) / Down (3)** button briefly to switch the function options.
- Press and hold the **Menu (4)** button to exit to the home screen or exit automatically if no operation within 5s.

13 Main Menu



- In the home screen, press and hold down the **Menu (4)** button for 3 seconds to enter the main Menu interface.
- In the main Menu, press the **Up (6) / Down (3)** button briefly to switch the menu option.
- Press the **Menu (4)** button briefly to adjust the parameters of present



option or enter to the submenu.

- Press and hold down **Menu (4)** button for 3 seconds to exit to the home screen.
- Press the **Power (10)** button briefly to save and exit to the upper interface.







Main Menu function description

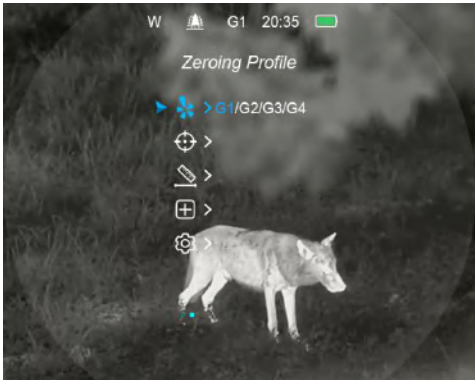

<p>Ultraclear</p> 	<p>Turn Ultraclear mode on/off</p> <ul style="list-style-type: none"> ● Press and hold down the Menu (4) button to enter the Main Menu. ● Select the Ultraclear option with the Up (6) / Down (3) button. ● Turn the Ultraclear mode on /off with a short press of Menu (4) button, along with the sound of shutter calibration. ● The icon will be displayed on the bottom status bar when the Ultraclear mode is on. ● Ultraclear Mode will show more image details under the cloudy, rainy, foggy and other harsh weather conditions.
<p>Wi-Fi</p> 	<p>Turn Wi-Fi function on/off</p> <ul style="list-style-type: none"> ● Press and hold down the Menu (4) button to enter the Main Menu. ● Select the Wi-Fi option with the Up (6) / Down (3) button. ● Turn the Wi-Fi function on /off with a short press of Menu (4) button. ● The icon will be displayed on the bottom status bar when the Wi-Fi is on.



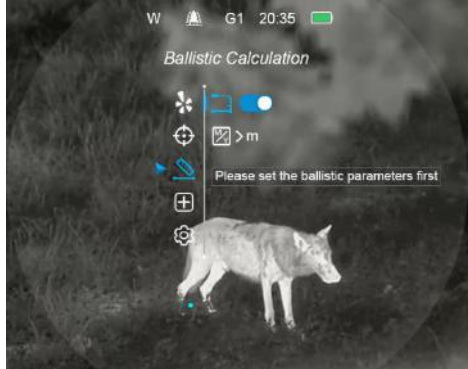

	<ul style="list-style-type: none"> ● When Wi-Fi is on, it can be connected with the mobile phone APP.
<p>Video Output</p> 	<p>Turn video output on/off</p> <ul style="list-style-type: none"> ● Press and hold down the Menu (4) button to enter the Main Menu. ● Select the Video Output option with the Up (6) / Down (3) button. ● Briefly press of the Menu (4) button to turn video output on/off. ● The icon will be displayed on the bottom status bar when the video output function is on. ● Video output function enable connectivity with an external display or recording device.
<p>Auto shutter calibration</p> 	<p>Turn the Auto shutter calibration on/off</p> <ul style="list-style-type: none"> ● Press and hold down the Menu (4) button to enter the Main Menu. ● Select the Auto shutter calibration option with the Up (6) / Down (3) button. ● Briefly press of the Menu (4) button to set the Auto shutter calibration mode on / off. ● The icon will be displayed on the bottom status bar when the Auto shutter calibration is on. ● When the Auto shutter calibration is on, the shutter will automatically when the Image quality deteriorates.
<p>Video UI</p> 	<p>Turn on/off the function of video recording with UI</p> <ul style="list-style-type: none"> ● Press and hold down the Menu (4) button to enter the Main Menu. ● Select the Video UI option with the Up (6) / Down (3) button. ● Briefly press of the Menu (4) button to set the Video UI mode on / off. ● The icon will be displayed on the bottom status bar when the Auto shutter calibration is on.





	<ul style="list-style-type: none"> ● If the Video UI function is on, the UI information will be recorded with the video.
<p>Zeroing Profile</p> 	<p>Select the Zeroing Profile (only for Attachment mode)</p> <ul style="list-style-type: none"> ● Press and hold down the Menu (4) button to enter the Main Menu. ● Select the Zeroing Profile option with the Up (6) / Down (3) button. ● There are four types for selection: G1/G2/G3/G4. <p>For MAH50:</p> <ul style="list-style-type: none"> - G1/G2: Recommended magnification of the day light optics for 1x-5x - G3/G4: Recommended magnification of the day light optics for 6x-10x <p>For MAL38:</p> <ul style="list-style-type: none"> - G1/G2: Recommended magnification of the day light optics for 1x-5x - G3/G4: Recommended magnification of the day light optics for 6x-8x <p>For MAL25:</p> <ul style="list-style-type: none"> - G1/G2/G3/G4: Recommended magnification of the day light optics for 1x-5x <ul style="list-style-type: none"> ● Briefly press of the Menu (4) button to Switch and select one zeroing type.







<p style="text-align: center;">Zeroing</p> 	<p>Zeroing (only for Attachment mode)</p> <ul style="list-style-type: none"> ● Press and hold down the Menu (4) button to enter the Main Menu. ● Select the Zeroing option with the Up (6) / Down (3) button. ● Briefly press of the Menu (4) button to enter the Zeroing interface. ● In the zeroing interface, short press the Up / Down / Camera / Menu button briefly to move the position of infrared image. ● Long press Menu (4) + Camera (5) buttons to save and exit the zeroing interface, or hold down Up (6) + Down (3) buttons for 3s to save and set the coordinate of the zeroing position as (0,0) and exit to the home screen. For the details, please refer to Section 10 Zeroing. 
<p style="text-align: center;">Ballistic calculation</p> 	<p>Ballistic calculation</p> <ul style="list-style-type: none"> ● Press and hold down the Menu (4) button to enter the Main Menu. ● Select the Range Notification option with the Up (6) / Down (3) button. ● Briefly press of the Menu (4) button to enter the Ballistic calculation interface. ● Briefly press Menu (4) to turn on/off Ballistic calculation function. You need to set the parameters of the Ballistic calculation through the InfiRay Outdoor APP before perform the ballistic calculation function. <p>Note: When setting the ballistic calculation parameters through the InfiRay Outdoor APP , you need to ensure that the</p> 

	<p>zeroing profile (G1/G2/G3/G4) settings in the APP are consistent with the MAH50R device.</p> <ul style="list-style-type: none"> ● Select Meters or Yards for range unit <p>Note: When the ballistic calculation is on, short press the Up (6) button to perform a single range.</p> <p>The distance value and the recommended ballistic offset (MOA / CM) will be displayed, and automatically disappear after 10 seconds.</p>	
<p>Pixels Defect Correction</p> 	<p>Pixels Defect Correction</p> <ul style="list-style-type: none"> ● Press and hold down the Menu (4) button to enter the Main Menu. ● Select the Pixels Defect Correction option with the Up (6) / Down (3) button. ● Briefly press of the Menu (4) button to enter the Pixels Defect Correction Interface. ● A reticle will appear in the center of the screen and the number of corrected defect pixels will display at the bottom of the screen. ● And then, moving the reticle to select the Defect Pixels by pressing the Up / Down / Camera / Menu button. ● After selecting the Defect Pixels, press and hold the Up (6) + Down (3) buttons at the same time to correct the blind pixels. <p>When the Add message appears on the bottom of the screen for a short time, the correction is successful.</p>	

	<ul style="list-style-type: none"> ● At the same position, press and hold the Up (6) + Down (3) buttons again to cancel the correction with the Del message appearing for a short time. ● The number of the defect pixels changes each time adding or deleting pixels correction. ● Repeat the above operations to continue selecting defect pixels. ● When the correction is done, press and hold the Camera (5) + Menu (4) buttons until display shows “Do you want to save these settings?” and “Yes” and “No” options. Select ‘Yes’ to save and exit, or select ‘No’ to cancel saving and exit. ● Switch the selection with the Up (6) / Down (3) button, and confirm your selection with the Menu (4) button. 	
<p>Settings</p> 	<p>This function is used to set the date, time, language, factory reset and view the device information.</p> <ul style="list-style-type: none"> ● Press and hold the Menu (4) to enter the main menu. ● Select the Settings option with the Up (6) / Down (3) button. ● Press the Menu (4) briefly to enter the submenu. ● This menu item allows you to configure the following settings. 	
<p>Date setting</p> 	<p>Date setting</p> <ul style="list-style-type: none"> ● In the settings submenu interface, select the Date option with the Up (6) / Down (3) button. The date is displayed in year/month/day format. 	

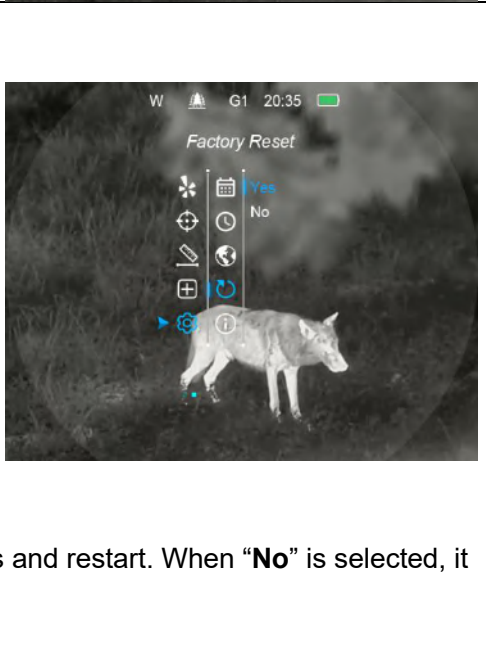
	<ul style="list-style-type: none"> ● Press the Menu (4) briefly to activate the date reset function. Two small triangle symbols are displayed above and below the 'Year' in default. ● Briefly press the Menu (4) button to switch among Year, Month, Day and Exit option. ● Press the Up (6) / Down (3) button to set the number. 	
<p style="text-align: center;">Time setting</p> 	<p>Time setting</p> <ul style="list-style-type: none"> ● In the settings submenu interface, select the Time option with the Up (6) / Down (3) button. The time is displayed in 24-hours format as Hour: Minute. ● Briefly press the Menu (4) button to activate the time reset function. Two small triangle symbols are displayed above and below the 'Hour' in default. ● Briefly press the Menu (4) button to switch between Hour, Minute and Exit option. ● Press the Up (6) / Down (3) button to set the time. 	
<p style="text-align: center;">Language</p> 	<p>Language setting</p> <ul style="list-style-type: none"> ● In the settings submenu interface, select the Language option with the Up (6) / Down (3) button. ● Enter the Language submenu with a short press of the Menu (4) button. 	

	<ul style="list-style-type: none"> ● Press the Up (6) / Down (3) button to select the language desired. ● Confirm your selection with a short press of the Menu (4) button and return to the upper interface automatically. 	
<p style="text-align: center;">Factory Reset</p> 	<p>Reset to the factory settings</p> <ul style="list-style-type: none"> ● In the settings submenu interface, select the Factory Reset option with the Up (6) / Down (3) button. ● Press the Menu (4) button to enter the Factory Rest interface. ● Press Up (6) / Down (3) button to select “Yes” or “No”. ● Confirm your selection with a short press of the Menu (4) button and return to the upper interface automatically. ● When “Yes” is selected, MATE will restore the factory settings and restart. When “No” is selected, it will return to the upper menu interface. 	
<p style="text-align: center;">Info</p> 	<p>System Information</p> <ul style="list-style-type: none"> ● In the settings submenu interface, select the Info option with the Up (6) / Down (3) button. 	

		<ul style="list-style-type: none"> ● Press the Menu (4) button to show the relevant information. ● This item allows the user to view the following information: the device model, GUI version, PN and SN number, Wi-Fi version, and FPGA version. ● Press and hold Menu (4) button to exit the Info interface. 	
--	--	---	---

14 Wi-Fi Function

MATE series has a built-in Wi-Fi module, which enables the device to connect wirelessly to external devices such as smart phones.

- Press and hold down the **Menu (4)** button to enter the Main Menu.
- Turn Wi-Fi function on /off with a short press of **Menu (4)** button.
- Retrieve the Wi-Fi signal named "**XXXXX_XXXXXX**" with an external device such as smart phone, which **XXXXX** represents the model and **XXXXXX** represents the SN code of the device.
- Select the Wi-Fi, and enter the password on the mobile device to set up

the connection. The initial password is 12345678.

- When Wi-Fi is successfully connected, you can control the device via InfiRay Outdoor APP.

Set the Wi-Fi name and password

The MATE series allows users to change the name and password of device Wi-Fi in the **InfiRay Outdoor** APP.

- After connected with the mobile device, find and click the "Setting" icon  in the **InfiRay Outdoor** to enter the setting interface.
- In the text box, enter and submit the new name (SSID) and password of the Wi-Fi.
- It needs to reboot the device to take the new name and password effect.
- Otherwise, clicking the synchronize time option in the setting interface can synchronize the time on the MATE with the mobile device.



Note : When restored factory settings, the Wi-Fi name, password, and system time are restored to the factory default settings.

15 Remote Control

MATE button module can be removed from the MATE and installed at any position of the gun with its own accessory as a remote control.

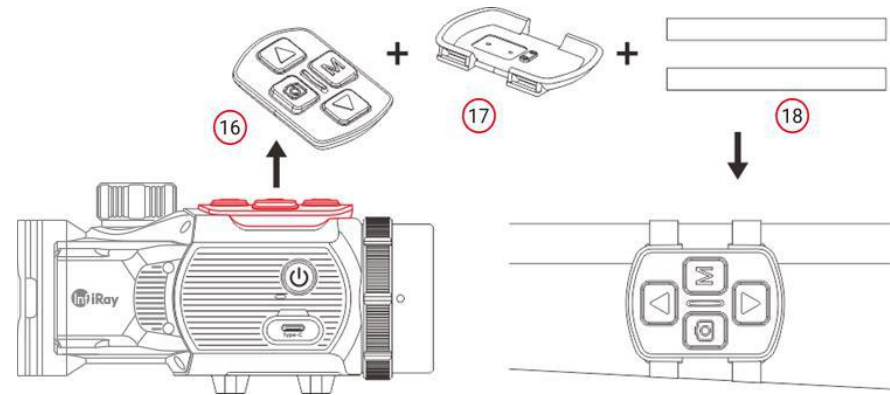

- Remove the button module **(16)** from MATE unite.
- Install the button module **(16)** on the base **(17)** provided with the package.
- Thread the two magic straps **(18)** into the base **(17)** and attach the module onto the suitable position of your gun.
- Then you can control the MATE remotely.
- The remote control has a built-in battery that can be used continuously for more than 30 days.
- If the battery runs out, reattach the button module **(16)** to the MATE and charge it automatically via the pogo pin.

16 Update and InfiRay Outdoor

better user experience, the software program, as well as parameters of the device will be constantly updated. Users can go to the official website (www.infirayouordoor.com) to download and update.

The MATE series support InfiRay Outdoor app technology, that can transmit the image via Wi-Fi from your scope to a smartphone or tablet and update the program.

Download and install the InfiRay Outdoor app from the official website (www.infirayouordoor.com) and app store, or scan the QR code below to download directly.



17 Technical Inspection

A technical inspection of the device is recommended before use.

- Check the external appearance of the device (there should be no cracks in the casing).
- Check the condition of the lens and eyepiece (there should be no cracks, greasy spots, dirt or other deposits)
- Check the condition of the rechargeable battery (this should be charged) and the electrical contacts (there should be no presence of salts or oxidation).

18 Maintenance

Maintenance should be carried out at least twice a year and consist of the following actions.

- Wipe the external surfaces of metal and plastic parts free of dust and dirt with a cotton cloth. Silicone grease maybe used for this.
- Clean the electrical contacts of the battery and battery slot on the unit using a non-greasy organic solvent.
- Check the glass surfaces of the eyepiece and the lens. If necessary, remove dust and sand from the lenses (preferably using a non-contact

method). Cleaning of the external surfaces of the optics should be done with substances designed especially for this purpose.

Carry out the recommended checks and troubleshooting steps in the order shown in the table. If there are defects that are not listed in the table or it is impossible to repair yourself, please contact with us as soon as possible. Private demolition is strictly prohibited.

19 General Trouble Shooting

The table lists all the problems that may occur when operating the device.

Trouble description	Probable reason	Trouble shooting
Fail to start up	Battery is low power	Charge your MATE or use the InfiRay Battery Pack
Fail to work with the remote control	Remote battery is low power	Attach the remote to the MATE's body and charge it via the pogo pin
Image is fuzzy, not clear, with vertical stripes and uneven background	No calibration for a long time	Perform the shutter calibration or background calibration
Image is too dark	Low screen brightness	Adjust the screen brightness
Blurred image with clear GUI	The objective lens is not focused	Adjust the focus ring of the objective lens until the image becomes clear
	There is dust or condensate on the interior or exterior optical surfaces of the lens	Wipe off the outside optical surfaces with a soft cotton cloth. Let it dry by leaving it in a warm environment for 4 hours
No analog video output	The video output function is not turned on	Turn the video output function in the Main Menu

	Data cable doesn't support data transmission	Replace a new data cable
Point of impact does not match the aiming point	Zeroing needs to be done	Do zeroing according to the section 12
	Zeroing profile is incorrect	Check the zeroing profile setting

20 Legal and Regulatory Information

Wireless transmitter module frequency range:

Bluetooth: 2.402-2.480GHz (For EU)

Wireless transmitter module power < 20dBm (only for EU)



We hereby declares that the radio equipment Mate series is in compliance with the Directives 2014/53/EU and 2011/65/EU

FCC Statement

FCC ID: 2AYGT-2N-00

Labeling requirements

This device complies with part 15 of the FCC Rules. Operation is subject to the following two conditions: (1) This device may not cause harmful interference, and (2) this device must accept any interference received, including interference that may cause undesired operation.

Information to the user

Any Changes or modifications not expressly approved by the party responsible for compliance could void the user's authority to operate the equipment.

EMC: Class A

Note: This equipment has been tested and found to comply with the limits for a Class A digital device, pursuant to part 15 of the FCC Rules. These limits are designed to provide reasonable protection against harmful interference when the equipment is operated in a commercial environment. This equipment generates, uses, and can radiate radio frequency energy and, if not installed and used in accordance with the instruction manual, may cause harmful interference to radio communications. Operation of this equipment in a residential area is likely to cause harmful interference in which case the user will be required to correct the interference at his own expense.

To comply with RF exposure requirements, a minimum separation distance of 0.00 cm must be maintained between the user's body and the handset, including the antenna.