

PFN640+

**Multi-functional night-vision
monocular user guide**

Publisher's note

The user manual details the multi-purpose use method and matters needing attention of multi-purpose night-vision monocular, to ensure the personal safety of operators, as well as to the utility of monocular goggles reasonable and effective maintenance and use, at the same time in order to ensure the normal use of multi-purpose night-vision monocular lifetime, the company requires the user to before using multi-purpose night-vision monocular,The following code of practice must be carefully read and strictly followed.

Prior to the publication of the new user manual, the use and maintenance of the multi-purpose night-vision monocular shall be subject to this reference. Other materials are for reference only.If any problem is found in use, please give feedback in time for study and modification.

The contents of this User's Manual are only for customers' reference and shall not be used as the criteria for judging product acceptance.

Contents

I Overview.....	1
II Performance¶meter.....	2
2.1 Performance.....	2
2.2 Parameter.....	3
III Configuration.....	4
IV Operation.....	5
4.1 Warning.....	5
4.2 Attention.....	5
4.3 Prepare.....	5
4.3.1 Unpark.....	5
4.3.2 Install battery.....	6
4.3.3 Install accessories.....	7
4.4 Keys function.....	8
4.5 On-Off.....	8
4.6 Diopter adjustment.....	9
4.7 Infrared lens focus.....	9
4.8 Shortcut keys.....	10
4.9 Firmware update.....	11
4.10 USB connection.....	11
V Menu operation.....	11
5.1 Working mode.....	12
5.2 E-zoom.....	13
5.3 Image of polarity.....	13
5.4 Image brightness.....	14
5.5 Contrast.....	14
5.6 Screen brightness.....	14
5.7 File management.....	14
5.8 Reticle settings.....	15
5.8.1 Reticle style.....	15
5.8.2 Reticle brightness.....	16
5.8.3 Reticle color.....	16
5.8.4 Calibration distance.....	16
5.8.5 Reticle position adjustment.....	16
5.9 Advanced settings.....	17
5.9.1 Wi-Fi switch.....	17
5.9.2 Video output switch.....	18
5.9.3 Automatic/Manual correction.....	18
5.9.4 Unit selection.....	18
5.9.5 Calibration type.....	18
5.9.6 Compass calibration.....	18
5.9.7 Blind pixel clear.....	19
5.9.8 Formatting.....	20
5.9.9 Time setting.....	20
5.9.10 Factory setting recovery.....	21
5.9.11 Status bar hidden switch.....	21
5.9.12 Version information.....	21
VI Wi-Fi function.....	22
VII APP introduction.....	23
VIII Maintenance.....	24
IX Trouble removal.....	25

I Overview

Multi-functional night-vision monocular is a handheld, helmet, clip-on, direct aim multi-purpose equipment, which is used for individual reconnaissance. Its multi-purpose use mode is shown in Figure 1. The night-vision instrument is light in weight, small in size, easy to carry, and has the characteristics of long working time and good concealment.



Figure 1 Working mode

II Performance¶meter

2.1 Performance

- 1) Support 4 modes of use: handheld, helmet, clip-on and direct aim;
- 2) High performance 12 μ m VOx detectors provide clear images at night and in harsh weather conditions;
- 3) 0.39inch 1024 \times 768,AMOLED display;
- 4) E-zoom 1x-4x;
- 5) Wi-Fi program update, transfer files;
- 6) Electronic compass, flip to automatically enter helmet mode;
- 7) Up to 1600 images and 40 hours of video on 64G internal memory;
- 8) 3 types of calibration guns, support custom calibration distance;
- 9) The vibration absorbing bracket is connected to absorb shock vibration, and the image is more stable;
- 10) Protection grade: IP67。

2.2 Parameter

Table 1 Technical parameters

Detector	640×512/12μm
Lens	f25mm/F1.0
Human recognition	600m
Vehicle recognition	1070m
NETD	≤40mK
Frame rate	50Hz
FOV	17.2°×13.7°
Focusing range	1m-∞
Eyepiece	14 ^x
Diopter	-4~4
Exit pupil distance	15mm-35mm
Polarity	White、Black、Red、Color
Battery life	≥4h
Battery type	1×18650/1×18700
Display	1024×768,0.39
Storage	64G
Interface	Picatinny,Helmet mount
Weight	≤360g
Dimensions (mm)	115×65×48
IP rating	IP67
Operating temperature	-40°C~50°C
Storage temperature	-50°C~60°C

III Configuration

Table 2 Configuration

sn	Name	Number	Additional
1	Multi-functional night-vision monocular	1	
2	Charger	1	
3	Power supply	1	
4	Video output cable	1	
5	Eyepiece cup(Clip-on)	1	
6	Scope mounts	1	
7	Soldier bag	1	
8	Cleanning cloth	1	
9	Helmet mount	1	
10	Helmet adapter	1	
11	Battery cover	1	
12	Allen Wrench 2.5	1	
13	Allen Wrench 3.0	1	
14	M4×6,hexagon socket head cap screws	2	
15	M4×8,hexagon socket countersunk head screws	2	

IV Operation

4.1 Warning

- Do not direct the multi-functional night-vision monocular into the sun, carbon dioxide lasers, welding machines and other high-intensity radiation sources;
- The time interval between two switching machines should be greater than 20 seconds;
- Multi-functional night-vision monocular uses precise optical instruments and electronic equipment sensitive to static electricity. Please do not throw, knock or vibrate the multi-purpose monocular night-vision apparatus and its accessories, to avoid deformation of structural parts or installation size, etc.
- Do not disassemble the multi-purpose monocular night-vision instrument by yourself, otherwise it will affect the seal of the whole machine. If there is a fault, please contact the factory in time, otherwise it will not be guaranteed;
- When not in use and in transit, remove the battery and place the MNIV in a protective equipment box;
- When the battery is too low in the process of use, please replace the battery in time to avoid damage to the battery caused by over-discharge;
- Excessive use conditions specified in this manual may cause damage to the multi-purpose monocular night-vision apparatus.

4.2 Attention

- When you need to clean the non-optical surface of the multi-functional night-vision monocular, do not use chemical solvents, diluents and other scrubbing, you can use a clean, soft, dry flannelette to wipe the shell;
- multi-functional night-vision monocular lens is coated with an anti-reflection film. It should be cleaned only when it is visibly soiled. Frequent wiping of the lens may cause wear and tear of the lens coating. Please avoid touching the lens surface. The acid on the skin left by fingerprints can damage the coating and lens surface. (Only use a dedicated lens cloth to clean the lens);
- If you do not observe the target for a long time after the observation is finished or the machine is turned on, please turn off the machine in time to extend the effective use time of the multi-purpose monocular night-vision instrument.

4.3 Prepare

4.3.1 Unpark

Before using for the first time, please be sure to open the box to check whether the set is complete.

- Open the equipment box and check the uniformity according to the configuration table of multi-functional night-vision monocular (Table 2);

- Check whether the lens, body, eyepiece, keys and vibration absorber bracket components of the multi-purpose monocular night-vision instrument are obviously damaged;
- Check the infrared lens and eyepiece for smudge. If there are obvious stains, wipe the infrared lens with lens cloth to ensure the lens is clean.

4.3.2 Install battery

The night-vision is equipped with two lengths of battery cover, which can be adapted to batteries with two lengths of 65mm and 70mm, as shown in Figure 2.

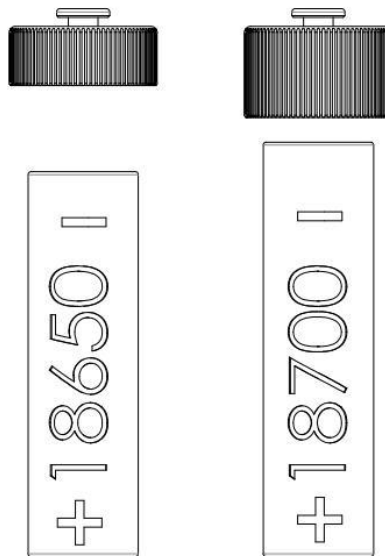

Figure 2 Install battery

- When installing the battery, please strictly follow the instructions on the label on the inner wall of the battery compartment and do not reverse install.
- Please be sure that the multi-functional night-vision monocular is turned off before dismounting the battery. Otherwise, it will cause serious damage to the equipment if the battery hatch is opened and the battery is removed under the boot state; Before using the multi-functional night-vision monocular for the first time, be sure that the battery is charged;
- Do not disassemble, throw, or make the battery short circuit in case of accidents;
- If the battery is used, charged and stored for a long time, it should be stopped immediately if overheating, discoloration, deformation, odor or other abnormal

phenomena are found.

Note: The night-vision cannot be shut down when using USB external power supply.USB external power supply 5V DC.

4.3.3 Install accessories

Install eyepiece cup:It is recommended to use a longer eyepiece cup for handheld mode and direct aim mode, and a shorter eyepiece cup for helmet mode and Clip-on mode.

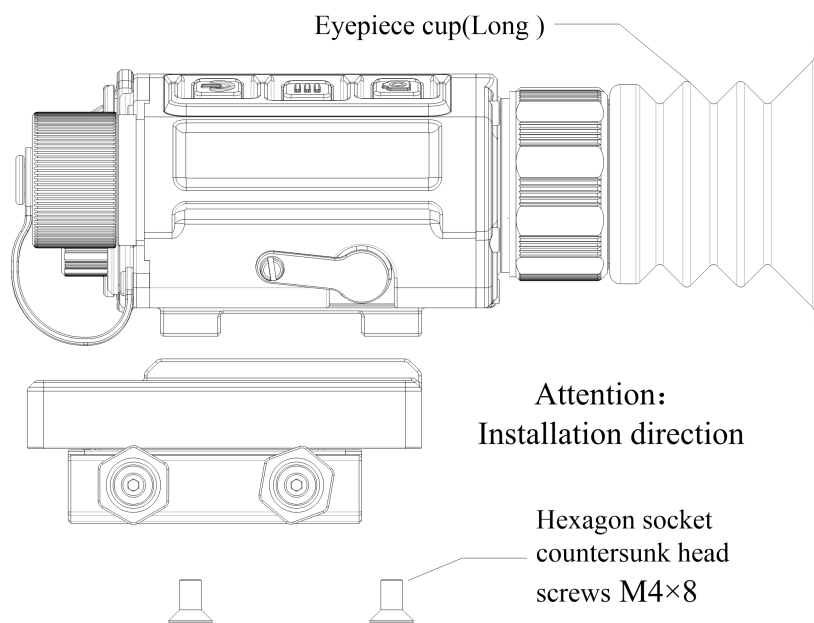

Figure 3 Install scope mounts

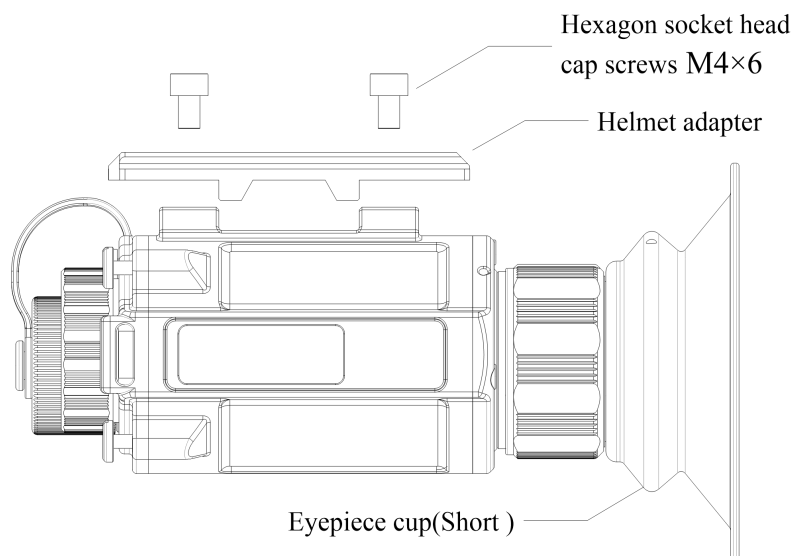

Figure 4 Install helmet adapter





Install scope mounts: The direct aim mode and Clip-on mode need to install the scope mounts, the installation direction is shown in Figure 3.

Install helmet adapter: The helmet adapter needs to be installed in helmet mode, as shown in Figure 4.

4.4 Keys function

The key diagram and function description of the multi-functional night-vision monocular are shown in Table 3.

Table 3 Key principle

Sn	Key	Current	Short press	Long press
1	Power 	Off	----	On
		Main interface	E-zoom	Off
		Menu	Switch options	----
		Reticle/Blind pixel correction	Move 1 pixel in the positive direction	Move 10 pixel in the positive direction
2	Menu 	Main interface	Enter menu	Switch mode
		Menu	Select	Return
3	Photo 	Main interface	Photo	On/Off record
		Menu	Switch options	----
		Reticle/Blind pixel clear	Move 1 pixel in the positive direction	Move 10 pixel in the positive direction
4	Power+Menu 	Main interface	On/Off sleep	----
5	Photo+Menu 	Main interface	Shutter correction	Background correction

Note: When performing image background correction, make sure the lens cover is closed.

4.5 On-Off

Long press power button 5 seconds turn on, as shown in Figure 5. Long press power

button in the power-on state to select shutdown according to the pop-up prompt, as shown in Figure 6.

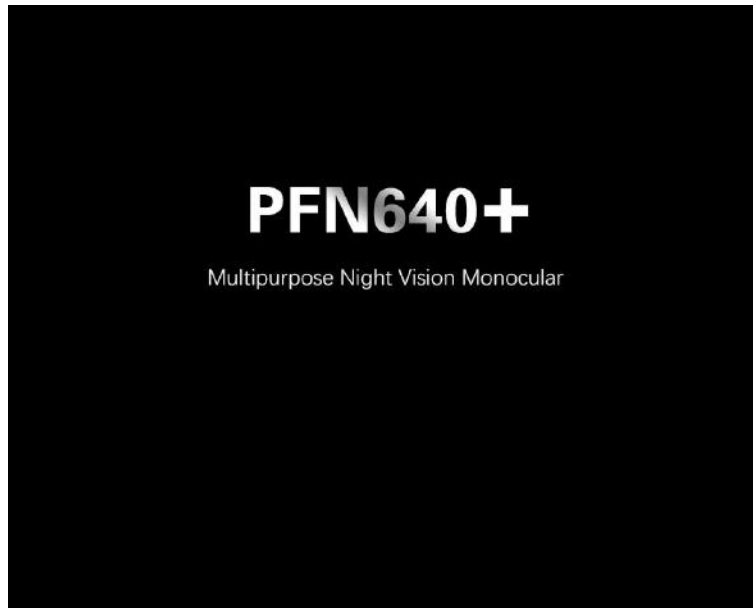

Figure 5 Boot screen



Figure 6 Shutdown prompt

4.6 Diopter adjustment

The night-vision has a diopter adjustment of $-4 \sim +4$. When the interface icon or text on the screen is blurred, it means that the eyepiece view does not match the user's view. Please adjust diopter.

After startup, slowly turn the eyepiece adjustment ring until the icon in the picture is clearly visible. Then the eyepiece has been adapted to the user's eye and the adjustment is completed.

4.7 Infrared lens focus

Focus by rotating the objective adjusting ring, until the image is clear.

4.8 Shortcut keys

Shortcut key operations are carried out in the main interface, as shown in Figure 7. If the status bar is automatically hidden, press any key to activate the status bar. After activation, you can perform shortcut operations.

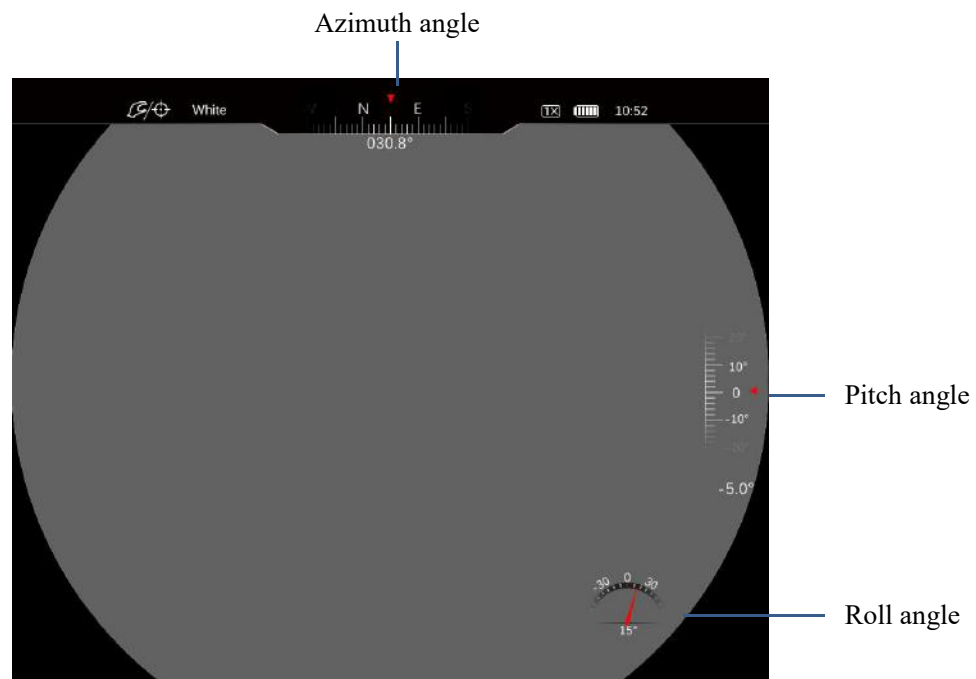

Figure 7 The main interface

Long press menu button to switch the working mode;

Short press power button to switch the E-zoom;

Short press power button + menu button to start sleep/cancel sleep; the night-vision will automatically shut down if there is no operation for more than 40 minutes;

Short press photo button + menu button to perform shutter correction; long press photo button + menu button to perform background correction. At this time, the display prompts to close the lens cover;

Short press photo button to take a photo, and icon will appear on the left side of the screen. After the photo is taken, the icon will disappear;

Long press photo button to record, and long press again to end the recording. When

recording, a recording icon will appear on the left side of the screen and the recording will be timed;

All files will be saved to the built-in memory card.

Note: a) Photographic operation can still be carried out during the video recording.

b) The maximum length of a single video file is 5 minutes. When the recording time exceeds 5 minutes, it will be automatically recorded into the next new file.

4.9 Firmware update

If the firmware to be upgraded has been uploaded to the device through Wi-Fi using the supporting software, the interface will prompt whether to upgrade the firmware when starting up, as shown in Figure 8. Users can choose whether to upgrade or not according to their needs.



Figure 8 Upgrade prompt

4.10 USB connection

Connect to USB. You can choose to use USB as a mobile storage device or as a serial port, as shown in Figure 9.



Figure 9 USB connect

V Menu operation

Short press the menu button to enter the menu, and repeatedly press power button/photo button to switch the menu of Working mode, E-zoom, Image polarity,

Image brightness, Contrast, Screen brightness, File management, Reticle setting and Advanced settings, as shown in Figure 10.

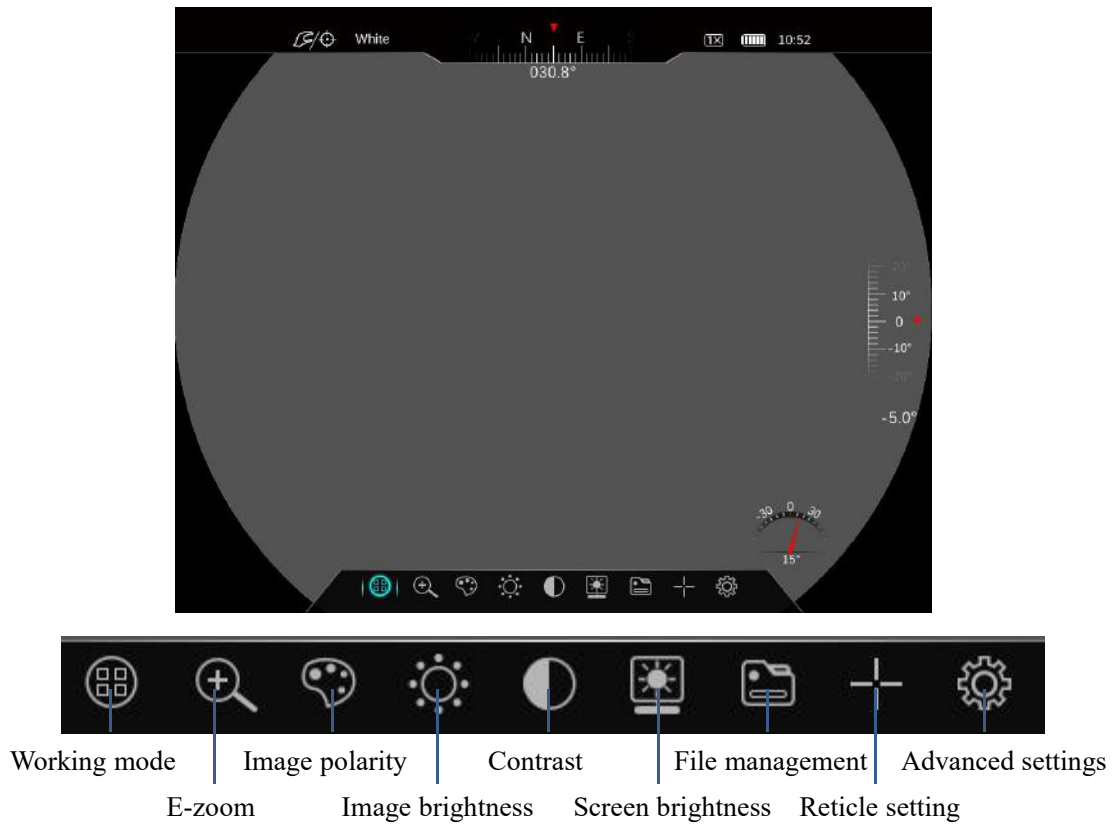

Figure 10 Menu

5.1 Working mode

Select the option of working mode, short press power button / photo button to switch Handheld / Direct aim and Clip-On, when the button is facing down, it will automatically enter the helmet mode. The current mode icon is located in the upper left corner of the display screen, as shown in Figure 11.



Figure 11 Working mode

By default, the length and width of the screen can be reduced to 70% in helmet mode and Clip-on. The Clip-on mode menu function only retains the working mode, image polarity, screen brightness, image brightness, contrast, and advanced settings. The

advanced settings provide Wi-Fi switch, video output switch, manual/automatic correction, and factory reset functions, such as Shown in Figure 12.

The recommended riflescope for Clip-on mode is 1x-4x.



Figure 12 Clip-on mode

5.2 E-zoom

The night-vision supports 1-4X image amplification to increase visual magnification. Select the E-zoom option, short press menu button to confirm this option, short press power button / photo button to realize 1×, 2×, 4× switch.(where 1 times is the default multiple of boot).

5.3 Image of polarity

Select the image polarity option, short press menu button to confirm this option, short press power button / photo button to realize the four polarity cycle switch of White, Black, Red and false Color.(White hot polarity is the default polarity)

5.4 Image brightness

Select the image brightness option, short press menu button to confirm this option, short press power button / photo button to adjust the image brightness, the image brightness is 0-9 level switch.(Level 5 is the factory default brightness, and the image brightness set in the last shutdown should be maintained after the machine is turned on.)

5.5 Contrast

Select the screen contrast option, short press menu button to confirm this option, short press power button / photo button to adjust the contrast, the contrast is 0-9 level switch.(Level 5 is the factory default contrast, and the contrast set in the last shutdown should be maintained after the machine is turned on).

5.6 Screen brightness

Select the screen brightness option, short press menu button to confirm this option, short press power button / photo button to adjust the screen brightness, the screen brightness is 0-9 level switch.(Level 5 is the factory default brightness, and the screen brightness set in the last shutdown should be maintained after the machine is turned on.)

5.7 File management

Please access the file management when Wi-Fi is off, otherwise you cannot enter the file management. After you enter file management, it is shown in Figure 13.

The file management interface consists of four areas: file list, file thumbnail, memory situation and operation menu.

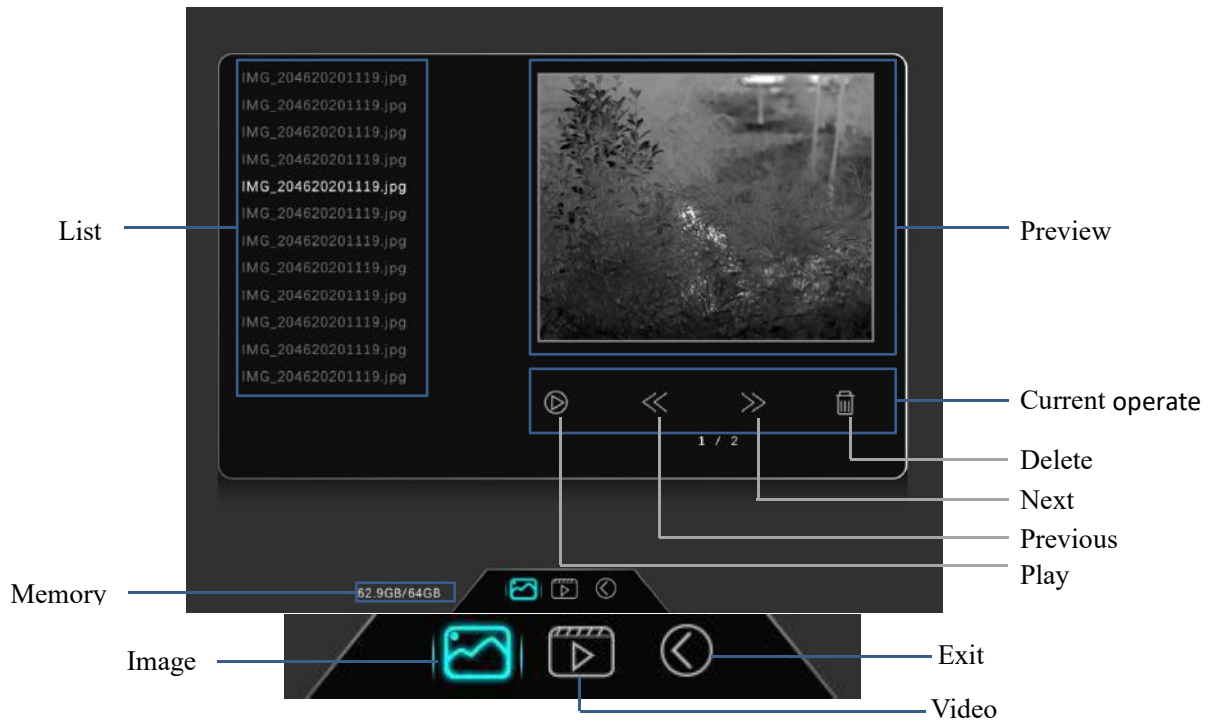

Figure 13 File management

5.8 Reticle settings

Under the Differentiation Settings menu, there are four function Settings to switch: Reticle style, Reticle brightness, Reticle color , Calibration distance and Reticle position, as shown in Fig. 14.

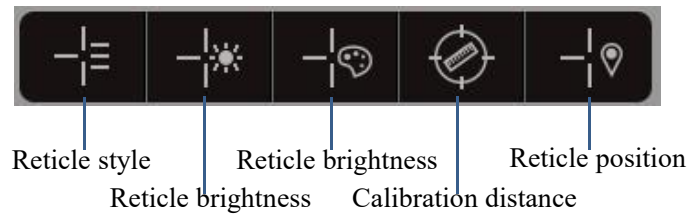

Figure 14 Reticle settings

5.8.1 Reticle style

The night-vision has 7 types of reticle styles for selection, as shown in Figure 15.



Figure 15 7 Reticle styles

5.8.2 Reticle brightness

The reticle brightness is 0-6 switch, a total of 7 kinds of partition brightness adjustable.

5.8.3 Reticle color

The reticle color has color of white, black, red, and green, a total of 4 kinds of reticle colors can be selected.

5.8.4 Calibration distance

The night-vision defaults with 100m, 200m and 300m calibration distances, corresponding to three types of calibration: A, B, and C. At the same time, it also supports user-defined setting of the calibration distance.

5.8.5 Reticle position adjustment

After entering the partition adjustment interface, the current calibration distance and calibration type can be displayed, select X for movement in the X direction and Y for movement in the Y direction.

Short press to move the partition in the corresponding direction by 1 pixel, long press to move 10 pixels, When calibrating distance at 100m, move 1 pixel to correspond to the change of 3.2cm in the status bar, as shown in Fig.16.

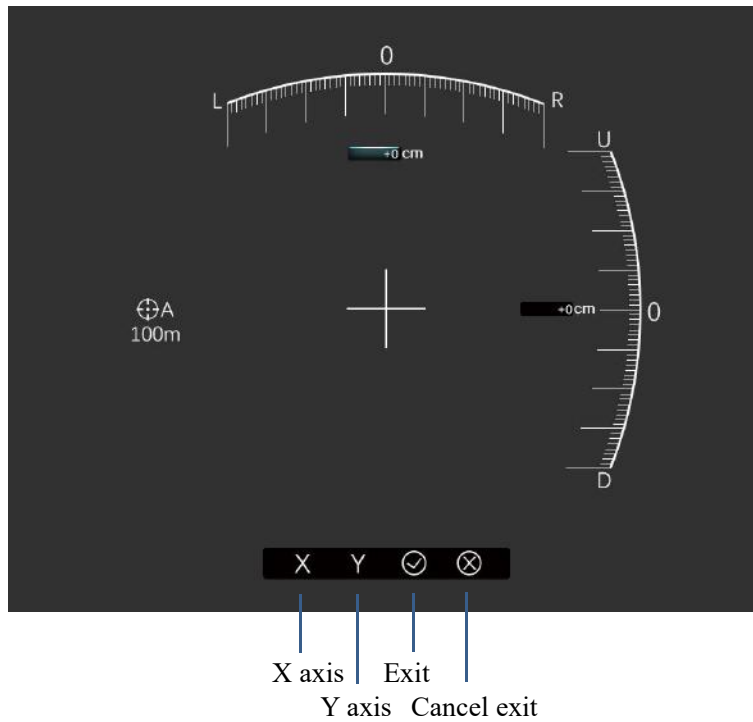

Figure 16 Reticle position adjustment

5.9 Advanced settings

Advanced settings include Wi-Fi switch, Video output switch, Automatic/Manual correction, Unit selection, Calibration type, Compass calibration, Blind pixel clear, Formatting, Time setting, Factory setting recovery, Status bar hidden switch and Version information, as shown in Figure 17.

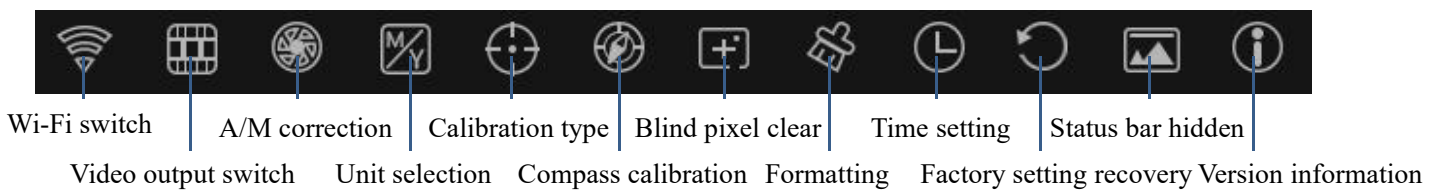

Figure 17 Advanced settings

5.9.1 Wi-Fi switch

After entering the advanced settings, short press menu button to enter the Wi-Fi switch option, short press power button/photo button to turn on or off Wi-Fi.

5.9.2 Video output switch

After entering the advanced settings, short press menu button to enter the video output switch option, short press power button/photo button to turn on or off the video output.

5.9.3 Automatic/Manual correction

After entering the advanced settings, short press menu button to enter the A/M correction options, short press power button/photo button to select A or M, where A means automatic shutter correction, and M means manual shutter correction.

5.9.4 Unit selection

After entering the advanced settings, short press menu button to enter the unit selection option, short press power button/photo button to select m or yd.

5.9.5 Calibration type

After entering the advanced settings, short press menu button to enter the calibration type option, short press power button/photo button to select A, B, C, respectively corresponding to 100m, 200m, 300m in the calibration distance selection, the current calibration type can be displayed at the reticle position adjustment interface.

5.9.6 Compass calibration

This operation is to calibrate the electronic compass. When the location of use is changed or the surrounding magnetic field environment changes greatly, this operation is needed to ensure the accuracy of the electronic compass.

Enter the compass calibration interface, and rotate the night-vision more than 360° along the arrows in X, Y and Z directions according to the icon on the screen to

calibrate the compass, as shown in Figure 18.

Automatically exit the compass calibration interface after 30 seconds (the button cannot be operated to exit).

Note: a) The rotation direction is not limited b) The rotation sequence of X, Y and Z is not limited, but the operation must be completed in all three directions c) The rotation axis is centered on the night-vision itself d) The rotation range must be greater than 360°

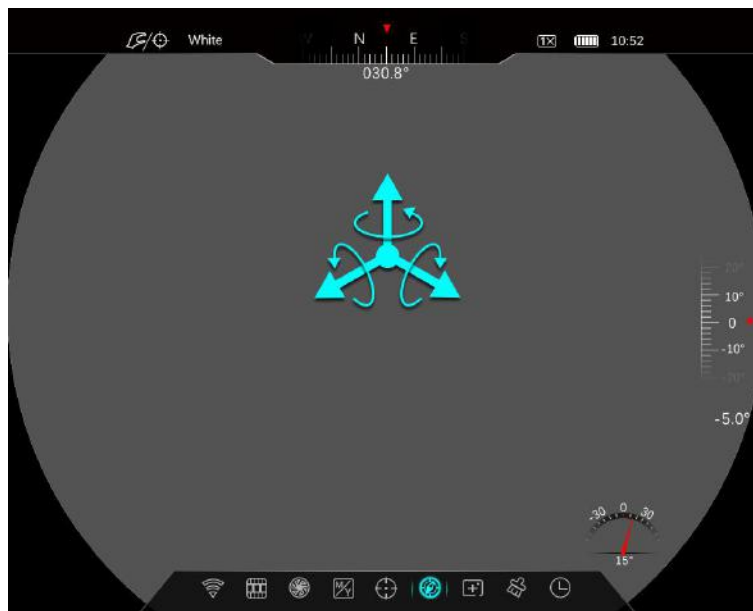

Figure 18 Compass calibration

5.9.7 Blind pixel clear

If the night-vision does not conform to the scene of the bright spots or dark spots (collectively referred to as blind elements), it can be operated to clear the blind pixel.

Under the option of blind pixel clear, press menu button to enter blind pixel clear.

Under the option of blind pixel clear, short press menu button to enter clear mode, and move the cursor by press power button/photo button (Short press to move 1 pixel, long press to move 10 pixels). After the cursor moves to the position of blind pixel, select the option of Add to confirm blind pixel clear, select the option of CXL to cancel blind pixel clear. Finally, select \checkmark to save and exit or select \times to cancel the save and exit to end this operation.

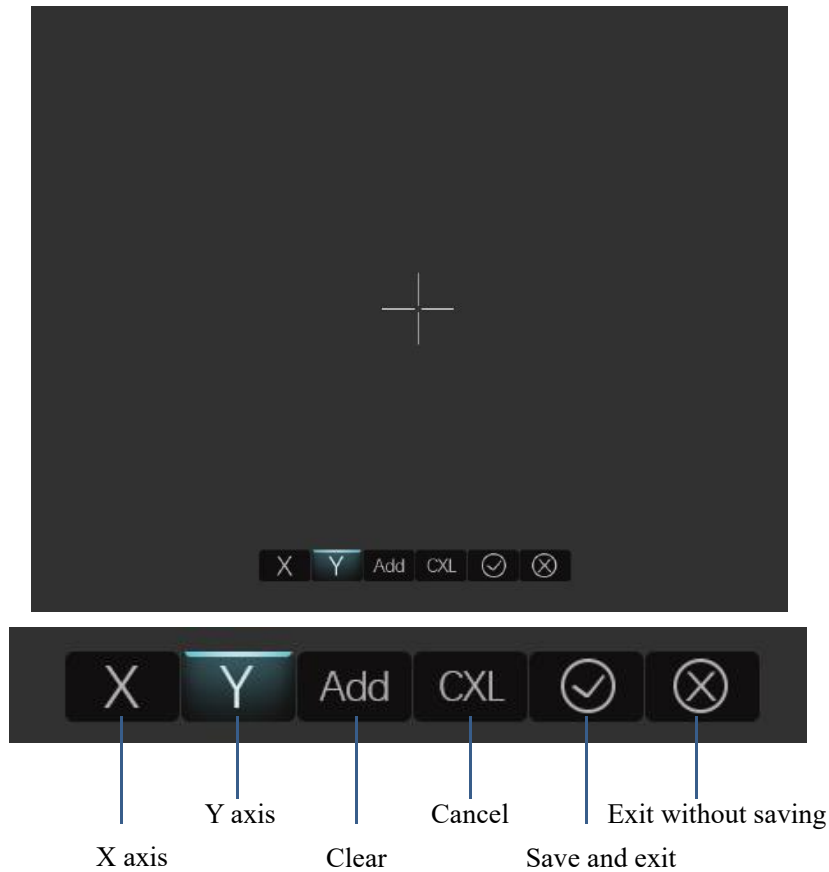

Figure 19 Blind pixel clear

5.9.8 Formatting

This function only formats the memory card.

After entering the formatting menu, a prompt box of whether to format will pop up, as shown in Fig. 20. Short press power button/photo button to select whether to format the memory card.

Note: Formatting operation is not reversible, please be careful. Do not perform other operations during formatting.



Figure 20 Formatting

5.9.9 Time setting

This action can be used to set the display time of the night-vision.

Enter the time setting interface, select the contents to be set according to the contents in the pop-up window, as shown in Fig. 21, and press power button/photo button to adjust the value. After setting, you can choose to save and exit or cancel the exit.

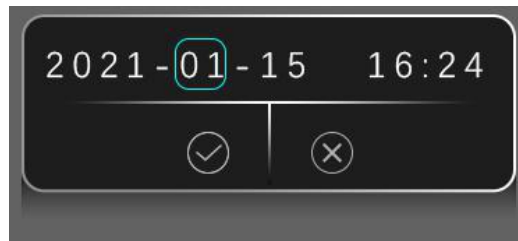

Figure 21 Time setting

5.9.10 Factory setting recovery

Under restore the factory default option, short press menu button, the next step operation pop-up window appears on the interface, as shown in Figure 22, the user chooses to confirm or cancel the operation according to the prompts.



Figure 22 Factory setting recovery

5.9.11 Status bar hidden switch

After entering the advanced settings, short press menu button to enter the status bar to hide the switch options, short press power button/photo button to turn on or off the automatic hiding of the status bar.

5.9.12 Version information

After entering the advanced settings, short press menu button to enter the version information, you can view the night-vision device model, software version and other information.

VI Wi-Fi function

The night-vision has a Wi-Fi module, and it can be connected to external devices (computers, phones) via Wi-Fi.

When Wi-Fi is turned on, search for the Wi-Fi named "INFRARE_XXXX" on the mobile device, where XXXX is a 4-digit serial code consisting of numbers and letters.

Select the Wi-Fi, enter the password and connect, the initial password is 123456789.

After the Wi-Fi connection is successful, the night-vision can be controlled through the APP on the mobile device. You can synchronize time and firmware upgrade operations in the Wi-Fi settings.

Take the Android as an example. Before updating the firmware, please copy the firmware to the mobile device in advance. The path is:

Android/data/com.infray.outdoor.wifiapp/files/infrared/others.

VII APP introduction

You can go to the website (www.xinfared.com) or search the infiray outdoor in the app store to download and install the app, or scan the QR code below for free download, as shown in Figure 23.



Figure 23 APP download

After the installation is complete, open the Infiray Outdoor app;

If your device is connected to a mobile device, please turn on the mobile data network on the mobile device. When the device is connected to the Internet, the update prompt will automatically pop up, click "Now" to download and update, or "Later" to update later;

Infiray Outdoor will automatically store the last connected device, so when the night-vision is not connected to a mobile phone or PC, open Infiray Outdoor, the APP will also automatically perform background update detection. If there is an update, if the mobile device is connected to the Internet, you can download the update first. After the download is complete, connect the night-vision to the mobile device to automatically update;

After the update installation is complete, long press power button to turn on, and enter the working state.

VIII Maintenance

- After the observation is completed or the target is not observed for a long time after starting the machine, the machine should be shut down in time to extend the effective use time of the night-vision.
- lens is an important optical component. During installation and use, avoid oil stains and various chemical substances to contaminate and damage the lens surface. After use, please cover the lens cap.
- When the night-vision is not in use and in transit, please remove the battery and place the night-vision in the equipment case.
- When long-term storage or not working, it should be stored in a cool and dry environment as far as possible.
- Do not use chemical solvents, diluents, etc. to scrub the machine case, you can use a clean, soft, dry flannelette to wipe.
- The lens should only be cleaned when it is obviously soiled. Please avoid touching the surface of the lens. The acid on the skin left by fingerprints will damage the coating and the surface of the lens.
- If not used for a long time, it should be electrified to check and calibrate once every six months.

IX Trouble removal

If there is a problem with the equipment, check and fix it according to the suggestions in the list. If the problem is not mentioned in the list, or cannot be repaired by yourself, please contact the supplier for repair.

Fault	Reason	Solution
Monocular can't open.	Low power	Charge
External power no available.	USB line damage	Change another use line
The image is not clear, vertical lines appear, or the background is uneven.	Need calibration	Do background correction or shutter correction in the menu
Image too dark	Brightness too low	Adjustment brightness in the menu
Poor image quality or reduced detection range .	Operating in the harsh environment	
Can't connect with phone or PC.	Wi-Fi code is wrong	Press the right code
	Disruptive by too much Wi-Fi net-work	Move the device far away from the area
Wi-Fi signal lost or interrupted .	Out of Wi-Fi coverage or there have obstruction	Reset the device where have Wi-Fi signal
When used at low temperatures, the image quality of the environment is worse than that at positive temperatures.	<p>Under the temperature condition above zero, the observed object (environment and background) will heat up differently due to different thermal conductivity, resulting in high temperature contrast, so the image quality will be higher.</p> <p>At low temperatures, the object being observed (the background) usually cools down to roughly the same temperature because the temperature contrast is greatly reduced and the image quality (detail) is poor, which is a feature of thermal imaging equipment.</p>	