

INFIRAY OUTDOOR
RICO MK2 LRF

Rugged Infrared Compact Optic



WARNING!

ITAR REQUIREMENTS

These products may be subject to export and foreign trade control laws of the United States and may not be exported without prior approval of the U.S. Department of State. Learn more at irayusa.com/ITAR.



CAUTION

Use of controls or adjustments or performance of procedures other than those specified herein may result in hazardous radiation exposure.

2601 State Hwy 121, Building 3, Suite 306, Lewisville, TX 75056
800.769.7125 info@irayusa.com

NOTICE: This product is a Class 3R laser product.

Explanatory Label



Mfr ID and Certification Label

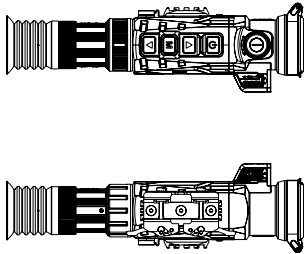
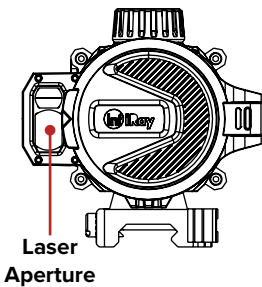

NOTE: There is no scheduled maintenance or service necessary to keep this product in compliance and no user service or maintenance is required.

This Laser Product is designated as Class 3R during all procedures of operation.

Wavelength: 900 nm

Laser Power for Classification: <700nJ

Emission Type: Pulsed, Invisible

Emission Frequency 10 kHz

Beam Diameter: 12 mm*2 mm

Divergence: 6 mRad*1mRad

INVISIBLE LASER RADIATION AVOID DIRECT EYE EXPOSURE CLASS 3R LASER PRODUCT

NOTES:

- There is no service required or allowed of this product by the end user.
- This product is to be serviced or repaired only by factory authorized technicians.
- This product is not to be opened or modified by the user.
- The user is not to modify the unit or remove protective covers or housing. Service is only to be handled by authorized factory trained technicians. This product has no user-serviceable parts.
- Do not point laser or allow laser light to be directed or reflected toward other people or reflective objects.
- Operators should be trained to not target the eyes of people, animals, and pets or aim at reflective objects, etc.
- There is a potential hazard of eye or skin exposure to laser radiation if the included instructions are not followed.
- This laser is never to be operated if the unit is defective or the cover or seal is damaged.
- Always operate the product with the aperture pointed downrange.

TABLE OF CONTENTS

1. Overview	2
2. Features	2
3. Tech Specs	3
4. Accessories	4
5. Components and Controls	5
6. Description of Control Buttons & Shortcuts ...	6
7. Quick Start Guide	8
8. Charging the Battery Pack	10
9. Installing the Battery Pack	11
10. Removing the Battery Pack	12
11. Battery Safety Warnings	12
12. External Power Supply	13
13. Mounting the RICO Mk2	13
14. Operating Instructions	15
15. Zeroing the RICO Mk2	20
16. Non-Uniformity Correction	21
17. Photography and Video Recording	22
18. Accessing the Internal Memory	24
19. Using The InfiRay Outdoor App	25
20. Integrated Laser Rangefinder	26
21. Digital Zoom	27
22. Ultra-Clear Mode	27
23. Main Menu Options and Descriptions	28
24. Basic Inspection	47
25. Basic Maintenance	47
26. Warranty	48
27. FCC Statement	49
28. General Troubleshooting	49
29. Notes	52

WARNING: CHOKING HAZARD

Children under 3 years old can choke or suffocate on small parts of this product. This product is not a toy; keep out of reach of children.

1. OVERVIEW

Built upon the RICO Mk1 series, the RICO Mk2 LRF was designed with an integrated 1,200-yard capable rangefinder, a 60hz refresh rate, and increased sensitivity to an impressive ≤ 20 mK. The RICO Mk2 features a high-performance 12 μm Micro II core, a 1750-yard detection range, and an ultra-high-contrast 2560 \times 2560 AMOLED HD display for an unparalleled viewing experience. The RICO Mk2 takes its image processing one step further with Advanced Image Correction and Automatic Image Optimization courtesy of its MATRIX III processor. An intuitive and easy-to-use interface combines with a picture-in-picture function, 5+ hour run-time, magnesium housing, 1000 G/s² shock resistance, and 32 GB of internal memory. The RICO Mk2 also unlocks advanced features such as a rotating zoom lever, magnetic charging port, and recoil activated video.

2. FEATURES

- 12 μm high-performance thermal detector
- ≤ 20 mK sensitivity
- 1200-yard integrated, high-precision laser rangefinder
- Stepped digital zoom from 1.0 \times –4.0 \times
- High image quality
- Magnesium alloy housing
- Quick-change rechargeable battery pack
- Maximum detection range 2400 yards
- HD 2560 \times 2560 AMOLED display
- High frame frequency: 60Hz
- Multiple reticle types and color options
- Supports multiple charging options, including a durable magnetic charging cable
- Recoil activated video
- Multiple zero profiles and ranges
- Built-in 32 GB storage to support image capture and video recording
- Built-in Wi-Fi module
- Mobile device App compatible
- Built-in gravity sensor
- Picture in Picture (PIP)
- User-friendly interface
- Pixel calibration functions

3. TECH SPECS

RICO MK2 LRF	RH50R
SENSOR	
Resolution	640×512
Pixel Size	12 μm
Frame Rate	60hz
Sensor Sensitivity	≤20 mK
Image Processing	MATRIX III
Core	InfiRay Micro II 640
OPTICS	
Objective Lens	50 mm f/1.0
Magnification	3×
Digital Zoom	4×, Stepped
Field of View	8.8° × 6.6°
Detection Range	2400 Yards
Display Type	1.03-inch Large-format AMOLED
Display Resolution	2560×2560
Color Palettes	White Hot, Black Hot, Red Hot, Rainbow, Violet, Crimson, Viridian
Reticle Types	8 (7 Static, 1 DIY)
Reticle Colors	Black Red, Black Green, White Red, White Green, Black White, White Black, Crimson, Viridian
Mounting System	Picatinny MIL-STD 1913 Rail
P.I.P.	Yes
Rangefinder	Integrated 1200 yd LRF
Eye Relief	60 mm
Diopter Range	-3 to +3
ELECTRONICS	
Onboard Recording	Video, Recoil-Activated Video, and Image
Onboard Storage	32 GB
Wireless Connectivity	Image and Video via App.
Data/Power Connector	USB-C
Power Supply	USB-C External, IBP-5 Li-ion Battery Packs (5+ Hours Each)
Start Up Time	<10 Seconds, Instant from Standby
PHYSICAL	
Size	9.50" × 3.00" 3.75 ?"
Weight	36.63 Oz
ENVIRONMENTAL/WARRANTY	
Warranty	5 Years
Housing Material	Magnesium Alloy
Ingress Protection	IP67
Operation Temperature	-4°F~122°F
Max. Recoil	1000 g/s ² (300 Win./7mm Mag)

4. ACCESSORIES

The RICO Mk2 rifle scope ships with everything you need to get out and hunt.

- 50mm Objective Lens Cap
- Standard Rubber Eyeguard
- Dual Throw Mount for RICO Mk2
- M5 Screws
- 3mm Hex Key and Spanner Tool
- Magnetic Charging Cable
- USB-C Cable
- IBP-5 Battery 4400 mAh
- IBC-5 Battery Charger
- USB Power Adapter
- Soft Case
- Lens Cloth
- User Manual



Various replacement accessories, are available for purchase. Contact 800-769-7125 or irayusa.com/support.

5. COMPONENTS AND CONTROLS

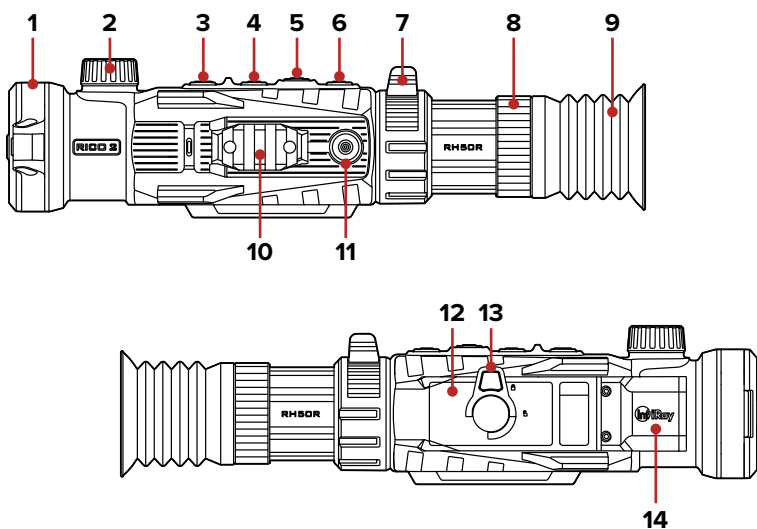



- 1 Objective Lens Cap
- 2 Objective Lens Focus Knob
- 3 Power Button
- 4 Up Button
- 5 Menu Button
- 6 Down Button
- 7 Zoom Lever
- 8 Eyepiece / Diopter Adjustment Ring
- 9 Eyeguard
- 10 Accessory Rail
- 11 Magnetic Charging Port / USB-C Port
- 12 IBP-5 Battery Pack
- 13 Battery Pack Pull-Ring
- 14 Laser Rangefinder

6. DESCRIPTION OF CONTROL BUTTONS AND SHORTCUTS

Power Button 		
Current Screen, Menu, or Device Status	Short Press	Long Press
Device off	---	Power on the device
Home screen	Perform a shuttered non-uniformity correction (NUC)	Power off the device
Main menu	Return to the previous menu without saving changes	---
Single or continuous rangefinding mode	Exit the rangefinding mode	Power off the device
Defect pixel correction & reticle zeroing interfaces	Exit the interface without saving	---

Up Button 		
Current Screen / Menu	Short Press	Long Press
Home screen	Enter single rangefinding mode	Enter continuous ranging mode
Single rangefinding mode	Take a rangefinding measurement	Switch from single to continuous rangefinding
Continuous rangefinding mode	---	Exit the rangefinding mode
Main menu / quick menu	Move the cursor up	---
Defect pixel correction & reticle zeroing interfaces	Move the cursor 1 pixel in the positive direction	Move the cursor 10 pixels in the positive direction



Power Button  + Up Button 		
Current Screen / Menu	Short Press	Long Press
Home screen	Enter the standby screen	---

Up Button  + Down Button 		
Current Screen / Menu	Short Press	Long Press
Home screen	Perform a shuttered non-uniformity correction (NUC)	---

Menu Button 		
Current Screen / Menu	Short Press	Long Press
Home screen	Enter the quick menu	Enter the main menu
Main menu	Change menu options; enter submenu; or confirm submenu changes and return	Save and return to home screen
Quick menu	Toggle through the menu options	Exit the quick menu
Defective pixel correction interface	Select / deselect axis of movement (X or Y)	Correct pixel(s) and return to previous
Reticle zeroing interface	Select / deselect the axis of movement (X or Y)	Save the new reticle position

Down Button 		
Current Screen / Menu	Short Press	Long Press
Home screen	Take a photo	Start / stop recording video
Main menu / quick menu	Move the cursor down	---
Defect pixel correction & reticle zeroing interfaces	Move the cursor 1 pixel in the negative direction	Move the cursor 10 pixels in the negative direction

Zoom Lever	
Current Screen / Menu	Rotate
Home screen	Adjust the digital zoom
In the screen brightness menu	Adjust the screen brightness

Menu Button  + Down Button 		
Current Screen / Menu	Short Press	Long Press
Home screen	---	Activate / deactivate reticle (Long press for 15 seconds)

7. QUICK START GUIDE

Step 1: Prepare to Use the RICO Mk2

1. Compare the box contents to the accessories list and examine each for any shipping damage. See **Accessories** on page 4.
2. Check the lens to ensure there are no smudges or dirt present. Clean with the included lens cloth, if necessary.
3. Charge the battery pack (12). See **Charging the Battery Pack** on page 10.
4. Install the eyeguard (9).
5. Mount the RICO Mk2 to the weapon. See **Mounting the RICO Mk2** on page 13.

Step 2: Turn On the RICO Mk2

1. Open the objective lens cap (1).
2. Long press the **Power**  **Button** for 3 seconds to power on the RICO Mk2.
3. Rotate the eyepiece diopter adjustment ring (8) until the interface icons are clear.

WARNING: Do not point the objective lens toward intense energy sources, such as the sun. This may render the electronic components inoperative. The warranty does not cover damage caused by improper operation.

Step 3: Adjust Settings in the Quick Menu

Short press the **Menu**  **Button** to enter the quick menu to adjust the following settings (see **Using the Quick Menu** on page 18):

1. Set the color palette to white hot, black hot, red hot, rainbow, violet, crimson, or viridian.
2. Select an image brightness level, from 0–10.
3. Select an image contrast level, from 0–10.
4. Select an image sharpness level, from 0–10.
5. Select a zero distance.

Step 4: Adjust Device Settings

1. Long press the **Menu**  **Button** to enter the main menu (see **Main Menu Options and Descriptions** on page 28 for detailed instructions) to:
 - a. Turn on Ultra-Clear mode.
 - b. Turn on the PIP window.

- c. Set the non-uniformity correction (NUC) mode to automatic (A) or manual (M).
 - d. Turn on the motion sensor.
 - e. Turn on recoil activated video.
 - f. Turn on the microphone.
 - g. Select a screen brightness level, from 0–100%.
 - h. Set the date and time.
 - i. Set the unit of measure to meters or yards.
2. From the home screen, rotate the zoom lever (7) to zoom in and out on the observed object.

Step 5: Set Up the Reticle and Zero the RICO Mk2

1. The reticle may be inactive when the RICO Mk2 is powered on for the first time. To activate the reticle, press and hold the **Menu** **[M]** and **Down** **[▼]** **Buttons** at the same time for 15 seconds from the home screen.
2. Adjust the reticle settings (see **Main Menu > Reticle** on page 29):
 - a. Set the zeroing profile to A, B, C, D, E, or F.
 - b. Set the reticle type to 1–7. A custom reticle is also available for purchase in the InfiRayOutdoor App.
 - c. Set the reticle color to black red, black green, white red, white green, black white, white black, crimson, or viridian.
3. Zero the rifle scope. See **Zeroing the RICO Mk2** on page 20.
 - a. Select, or customize, a zero distance that matches the target distance.
 - b. Zero the reticle.

8. CHARGING THE BATTERY PACK

The RICO Mk2 rifle scope comes with two long-lasting rechargeable lithium-ion IBP-5 battery packs, which allow for 5+ hours of operation each. The IBP-5 battery packs use a cam-locking mechanism to ensure quick and secure battery changes in the field. Fully charge the battery packs before using the RICO Mk2 for the first time.

Charging with the Battery Charger

1. Insert a battery pack (12) into the battery charger (15). Align the slots (A) on the edge of the battery pack with the pins (B) on the inside of the charger.
2. Connect the USB-C cable (16) to the USB-C port (C) on the battery charger.
3. Connect the standard USB end of the data cable to:
 - a. The included 5V–2A USB power adapter; **OR**
 - b. Any standard USB 3.0 port on a laptop or computer.
4. During charging, the LED status indicator (D) on the battery charger will be solid red.

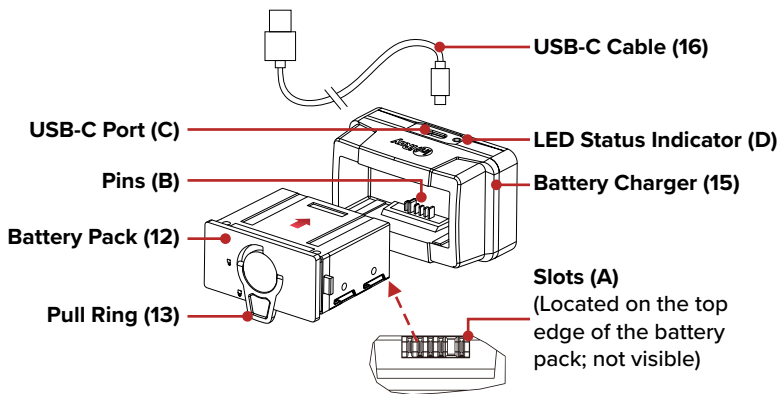

5. When fully charged, remove the battery pack from the battery charger.
 - a. The LED status indicator will turn solid green when the battery is fully charged. Do not overcharge.



NOTE: When the LED status indicator flashes red, the battery charger is connected to a power source but no battery pack is installed.

WARNING: Never use the battery charger with a USB power adapter that is greater than 5V–2A.

Charging Via the Magnetic Charging Port

1. Place the magnetic charging cable on the magnetic port (11) on the side of the rifle scope.
2. Connect the USB end of the magnetic charging cable (17) to:
 - a. The included 5V–2A USB power adapter; **OR**
 - b. Any standard USB 3.0 port on a laptop or computer; **OR**
 - c. An external power supply, such as a USB power bank.

Charging via the USB-C Port

1. Remove the magnetic charging port and connect the USB-C cable (16) to the USB-C port (11) behind it.
2. Connect the standard USB end of the data cable to:
 - a. The included 5V–2A USB power adapter; **OR**
 - b. Any standard USB 3.0 port on a laptop or computer; **OR**
 - c. An external power supply, such as a USB power bank.
3. During charging, the battery status  icon in the status bar changes to the battery charging  icon.
4. When fully charged, disconnect the charging cable.

NOTES:

- You may charge and operate the RICO Mk2 at the same time.
- The battery status icon turns red  when the battery is below 20%; charge right away to avoid over-discharge and a reduction in battery capacity or service life.

9. INSTALLING THE BATTERY PACK

1. Pull out the pull-ring (13) on the battery pack (12) and rotate it clockwise 90 degrees until it is horizontal to the battery pack.
2. Position the battery pack with the slots (A) facing up. Align the slots (A) on the edge of the battery pack with the pins (B) on the inside of the battery compartment.
3. Firmly press the battery in to install it.

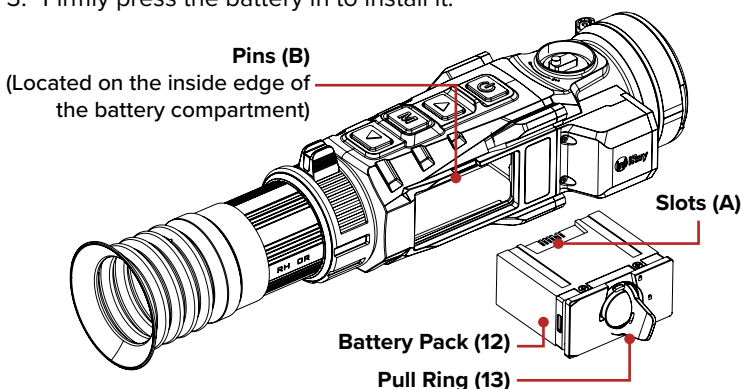

4. Rotate the pull-ring counterclockwise 90 degrees to the vertical position to lock the battery pack in place.

WARNING: The RICO Mk2 can only be powered by a factory-supplied IBP-5 battery pack. Using any other battery pack may cause irreparable damage to the rifle scope or cause a fire. Any damage from using an improper battery pack will not be covered by warranty.

10. REMOVING THE BATTERY PACK

To remove the battery pack from the RICO Mk2:

1. Pull out the pull-ring (13) on the battery pack (12) and rotate it clockwise 90 degrees until it is horizontal to the battery pack.
2. Pull the battery pack out.

11. BATTERY SAFETY WARNINGS

WARNING: Only use the battery charger supplied with the battery pack. The use of any other charger may irreparably damage the battery pack or the charger and may cause a fire. Any damage from using an improper battery charger will not be covered by warranty.

WARNINGS:

- Do not use a battery charger, power adapter, or USB cable that has been modified or damaged.
- Do not expose the battery to high temperatures or open flame, and do not immerse it in water.
- Do not leave the battery unattended while charging.
- Do not leave the battery charging for long periods after full charge is reached. Charging time should not exceed 24 hours.
- Keep the battery pack out of the reach of children and pets.
- The battery is equipped with short-circuit protection. However, any situation that may cause short-circuiting should be avoided.
- Do not disassemble, modify, hit, or drop the battery pack.
- Do not connect the battery to any external device with an electrical current that exceeds permitted levels.
- Do not connect an external device with a current supply that exceeds the 3.0 USB port.



To maintain optimal battery capacity and service life:

- Avoid storing a fully charged or discharged battery for long periods. Partial charging of the battery is necessary if the battery will be stored for an extended period.
- Do not charge an extremely cold battery. Allow the battery to warm up for about 45 minutes before charging.

- Charge the battery at a temperature range from 32°F to 113°F; otherwise, the service life of the battery may be reduced.
- The recommended operating temperature range is -4°F to 122°F. Avoid using the battery above the maximum or below the minimum recommended temperature range as this may decrease the battery capacity or service life.

12. EXTERNAL POWER SUPPLY

The RICO Mk2 supports the use of a 5V external power supply, such as a mobile power bank. To connect to an external power supply:

1. Connect the USB-C cable (16) to the USB-C port (11).
2. Connect the other end of the USB-C cable to the external power supply.
3. The RICO Mk2 will switch to operation from the external power supply, and the internal battery pack will begin slowly charging.
4. In the status bar, the battery status  icon will change to the battery charging  icon.
5. If the external power supply is disconnected, the RICO Mk2 will automatically switch to the battery pack, if installed, without powering off.

NOTE: Do not connect the RICO Mk2 to an external device with a power supply that exceeds the 3.0 USB cable.

13. MOUNTING THE RICO MK2

Installing the Dual Throw Mount

Before using the RICO Mk2, install the IRAY-AC109 dual throw mount (18) to the three mounting holes in the base of the rifle scope.

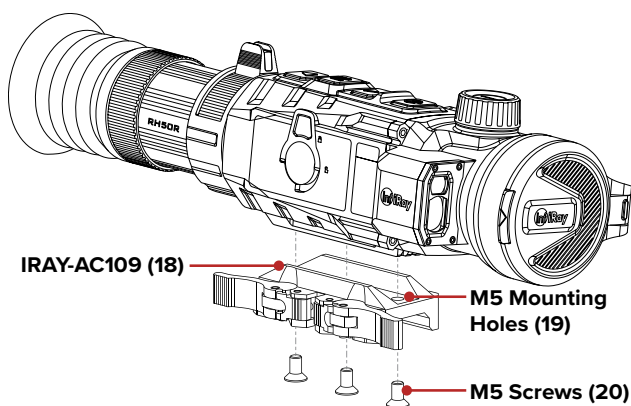

1. Install the dual throw mount (18) to the base of the RICO Mk2 using a 3mm hex key and the M5 screws (20) supplied in the package.

2. Install the RICO Mk2 to the rifle and adjust its position so that it produces a clear image and is comfortable for the shooter.
3. When the location is suitable, remove the M5 screws one at a time and apply a small amount of blue Locktite 242 to the threads.
4. Reinsert each screw and tighten to 20 in/lbs with a torque wrench. Allow the threadlocker to dry.

NOTE: Please note, torque is inch-pounds, NOT foot-pounds. If you do not have a torque wrench, apply until snug. Do not overtighten.

When the threadlocker is dry, install the mount and rifle scope to the Picatinny rail of your rifle.

1. Press the locking button (21) and pull the locking lever (22) to open each throw lever.
2. Install the mount to the Picatinny rail.
3. Press the levers closed to lock the mount in place. You will hear the lever and locking button click.

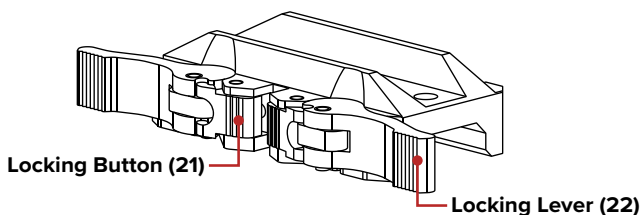

The RICO Mk2 is now ready to be zeroed. See **Zeroing the RICO Mk2** on page 20 for instructions.

Adjusting the Throw Lever Tension

If you cannot slide the mount onto the Picatinny rail because the throw levers are in the open position but the locking plate is not, or if the mount is not tight to the rail after the throw levers are closed, you may loosen or tighten the tension of the throw levers by adjusting the nuts (23).

1. Open both throw levers. This will cause the adjustment nuts (23) to protrude on the opposite side of the mount.
2. Use the prong-side of the included spanner tool to turn the adjustment nut clockwise to tighten, or counterclockwise to loosen, to achieve the correct amount of tension. You should not feel any tension on the locking lever when closing until it reaches a 45-degree angle. Do not overtighten.

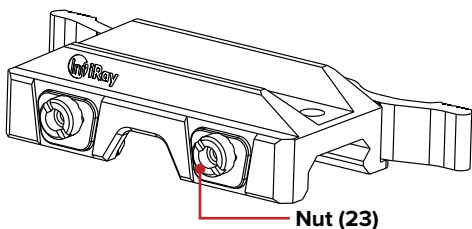

14. OPERATING INSTRUCTIONS



WARNING!

Don't point the objective lens towards any intense energy sources, such as laser radiation or the sun. This may render the electronic components inoperative. The warranty does not cover damage caused by improper operation.

Using the Control Buttons

The RICO Mk2 is operated via four control buttons. The control buttons can be used to perform shortcut operations from the home screen, as well as in the menu and full-screen interfaces. See **Description of Control Buttons and Shortcuts** on page 6 for shortcut button details.

Powering On

1. Open the objective lens cap (1).
2. Long press the **Power**  **Button** for 3 seconds to turn on the rifle scope. The InfiRay Outdoor logo will appear.
3. To determine the current battery charge, check the battery status  icon and battery charge percentage in the top status bar.

Powering Off and Entering Standby

To power off the RICO Mk2:

1. Long press the **Power**  **Button**. The shutdown screen will open, showing a 3-second countdown.
2. The RICO Mk2 will shut down automatically when the 3-second countdown completes.

NOTE: Press any button before the countdown completes to cancel the shutdown and return to the home screen.

WARNING: If using an external power supply, do not remove the power supply when saving data, as the data may not be saved.

STANDBY MODE

Manually Enter Standby Mode

1. To enter standby at any time from the home screen, long press the **Power**  and **Up Buttons** at the same time.
2. Short press any button to exit standby.

Set the RICO Mk2 to Enter Standby Mode Automatically

The rifle scope may be set to automatically enter standby mode.

1. In the main menu, turn automatic standby on. When turned on, the RICO Mk2 will automatically enter standby after 5 seconds of inactivity. See **Main Menu > Standby** on page 39.
2. Press any button or move the rifle scope to exit standby.

STANDBY NOTES:

- When automatic standby is turned **on**:
 - The RICO Mk2 will enter standby mode automatically when it is tilted up or down at an angle of more than 70° or left or right at an angle of more than 30°.
 - The RICO Mk2 will not enter standby mode while it is in a level (horizontal) firing position.
- When **off** is selected, standby mode is turned off and the rifle scope will operate until the battery runs out.

Adjusting the Focus

ADJUSTING THE DIOPTER/EYEPIECE

1. Rotate the eyepiece diopter adjustment ring **(8)** at the rear of the rifle scope right or left until the user interface is clear.
2. Look closely to ensure all icons, the status bar, and the reticle appear sharp and in focus. No additional diopter adjustments are required unless the user wishes to make changes.

NOTES:

- After the initial adjustment, there is no need to rotate the eyepiece adjustment ring **(8)** for long distances or other conditions.
- If necessary during standard use, the objective lens focus knob **(2)** may be rotated to adjust fine focus on the target object being observed. See **Focusing the Objective Lens** below.

FOCUSING THE OBJECTIVE LENS

To adjust the focus on the target object:

1. Rotate the objective lens focus knob **(2)** left or right to adjust fine focus.

NOTE: Re-adjusting the focus will be necessary if the distance to the target changes.

Activating / Deactivating the Reticle

1. The reticle may be inactive when the RICO Mk2 is powered on for the first time. To activate the reticle, press and hold the **Menu** **[M]** and **Down** **[▼]** **Buttons** at the same time for 15 seconds from the home screen.

Status Bar Overview

The status bars at the top and bottom of the screen show information on the operating status of the RICO Mk2.









- 1 Photo:** The camera icon appears briefly when a photo is taken. A warning icon appears when insufficient memory storage is available.
- 2 Recoil Activated Video:** The recoil activated video (RAV) icon will appear when RAV is turned on.
- 3 Video Timer:** The video timer will appear during video recording.
- 4 Time:** Shows the current time in 24-hour format.
- 5 Battery Status:** Shows the battery status.
- 6 Battery Charge:** Shows the current battery charge level.
- 7 Zeroing Profile and Distance:** Shows the selected zero profile, A, B, C, D, E, or F, and the zero distance.
- 8 Magnification:** Shows the total magnification.
- 9 Ultra-Clear:** Shows the Ultra-Clear status, on or off .
- 10 Non-Uniformity Correction (NUC) Mode:** Shows the icon for the selected non-uniformity correction (NUC) mode, automatic or manual . When automatic mode is selected, a countdown timer icon will appear when 5 seconds remain until a NUC.
- 11 Wi-Fi:** Shows the Wi-Fi status, on , on but not connected , or off .
- 12 Standby Status:** Shows the standby icon and the status, on or off.
- 13 Microphone:** When on, the microphone icon appears.

Using the Quick Menu

In the quick menu, the color palette, image brightness, image contrast, image sharpness, and zero distance can be quickly adjusted.



- On the home screen, short press the **Menu [M] Button** to enter the quick menu.
- Short press the **Up [▲] or Down [▼] Button** to move between the menu options below. The selected menu item is highlighted in the background.
 - **Color Palette:** Short press the **Menu [M] Button** to set the color palette to white hot , black hot , red hot , rainbow , violet , crimson , or viridian .
 - **(Image Brightness):** Short press the **Menu [M] Button** to set the image brightness level, from 1–10.
 - **(Image Contrast):** Short press the **Menu [M] Button** to set the image contrast level, from 1–10.
 - **(Image Sharpness):** Short press the **Menu [M] Button** to set the image sharpness level, from 1–10.
 - **(Zero Distance):** Short press the **Menu [M] Button** to select a zero distance within the selected zeroing profile. Only the zero distances in the selected profile will be available for selection. The selected zeroing profile and distance appear in the bottom status bar.
- Long press the **Menu [M] Button** to save any changes and return to the home screen.

NOTE: In the quick menu, after 5 seconds of inactivity, the system will automatically save any changes and return to the home screen.











Navigating the Main Menu



- From the home screen, long press the **Menu [M] Button** to enter the main menu.
- Short press the **Up [▲] or Down [▼] Button** to move up and down through the menu options.
- A blue arrow **>** icon indicates the cursor position in the menu.
- Short press the **Menu [M] Button** to:
 - Change the parameters for the selected menu option; **OR**
 - Enter the submenu; **OR**
 - Confirm submenu changes and return to the previous menu.
- Long press the **Menu [M] Button** to confirm any changes and return to the home screen.
- Short press the **Power [⏻] Button** to return to the previous menu without saving.
- After 15 seconds of inactivity, the menu will automatically close and the interface will return to the home screen. Changes (except changes to toggle on / off menu items, such as Ultra-Clear and Wi-Fi) are not saved automatically.
- Upon exiting from the main menu the cursor location is stored for a single working session (until the RICO Mk2 is turned off). After restarting the RICO Mk2 and entering the menu, the cursor position will be at the first menu item.

15. ZEROING THE RICO MK2

RICO Mk2 features a “freeze” zeroing method. To zero the RICO Mk2:

1. Set a suitable target at the desired zero distance.
2. Confirm that the rifle is empty, safe, and pointed in a safe direction, with no ammunition near the weapon.
3. Adjust the image and device settings following the steps in the **Quick Start Guide** on page 8, if you have not done so already.
4. Set the zeroing profile to A, B, C, D, E, or F. See **Reticle Menu > Zeroing Profile** on page 29.
5. Based on the distance to the target you wish to zero, select or customize a zero distance to match. See **Zeroing Menu > Customize Zero Distance** on page 35.
6. Ensure a stable platform and natural shooting position is achieved behind the rifle.
7. Load ammunition, aim, and take one good shot at the target.
8. Make your rifle safe and observe the location of impact on the target.
9. If the point of impact does not match the point of aim (the center of the reticle), adjust the X/Y position of the reticle. See **Zeroing Menu > Reticle Zeroing** on page 32.
10. In the submenu for the selected zero distance, center the reticle on the aiming point and freeze the image view.
 - a. Short press the **Down**  **Button** to move to the image freeze  icon. The cursor position is indicated by a blue arrow  icon.
 - b. Short press the **Menu**  **Button** to freeze the image. The icon will turn from white to blue.
11. Select the axis (X or Y) along which to move the reticle.
 - a. Short press the **Up**  or **Down**  **Button** to move between X and Y. The cursor position is indicated by a blue arrow  icon.
 - b. Short press the **Menu**  **Button** to select X or Y. The selected axis will turn from white to blue.
12. Adjust the X/Y position of the reticle until the reticle matches the point of impact.
 - a. Use the **Up**  **Button** to move in the positive direction:
X= Right and Y= Up.
 - b. Use the **Down**  **Button** to move in the negative direction:
X= Left and Y= Down.
 - c. Upon moving the reticle, a red cursor appears on the screen, representing the original position of the reticle.
13. Long press the **Menu**  **Button** to save the reticle position.

14. Take a confirmation shot—the point of impact should now match the point of aim. If not, adjust the X/Y position of the reticle again.

For detailed Zeroing instructions, please see **Zeroing Menu > Reticle Zeroing** on page 32.

16. NON-UNIFORMITY CORRECTION

A non-uniformity correction (NUC) allows a thermal imager's sensors to correct its pixels and eliminate any image defects caused by pixel drift. A NUC will be performed automatically each time the RICO Mk2 is powered on.

The RICO Mk2 has two non-uniformity correction (NUC) modes, automatic (**A**) and manual (**M**). In either mode, the user may choose to manually perform a NUC (shuttered or shutterless) at any time. See **Main Menu > Calibration Mode** on page 37 for instructions on setting the NUC mode.

Automatic Mode

In automatic mode (**A**), the RICO Mk2 will perform a shuttered NUC automatically according to the internal software algorithm. There is no need to close the objective lens cap (**1**) as the RICO Mk2's internal shutter covers the sensor.

When automatic mode is selected, a countdown timer icon will appear when 5 seconds remain until a NUC. The timer will appear only after the microbolometer temperature has stabilized—after approximately 10 minutes of continuous operation of the RICO Mk2.

NOTE: A manual NUC (see below) may be performed at any time while in Automatic (**A**) mode.

Manual Mode

In manual mode (**M**), the user independently determines the need to perform a shuttered or shutterless NUC based on the quality of the observed image.

Performing a Shuttered NUC



A shuttered NUC may be performed at any time while in manual or automatic mode. It is not necessary to close the objective lens cap (**1**) during a shuttered NUC, as the internal shutter covers the sensor.

1. From the home screen, short press the **Power**  **Button**.
2. The internal shutter will cover the sensor and a shuttered non-uniformity correction (NUC) will be performed instantly.

Performing a Shutterless NUC

The user may perform a shutterless NUC based on the quality of the observed image. A shutterless NUC uses less power than a shuttered NUC because it does not use the imager shutter to cover the sensor; instead, the user must close the lens cap (1).

A shutterless NUC may be performed in manual or automatic mode:

1. Close the objective lens cap (1).
2. From the home screen, short press the **Up**  and **Down**  **Buttons** at the same time.
3. A prompt to close the lens cap (1) appears onscreen. The shutterless NUC starts after about 2 seconds.

NOTE: If the lens is not properly covered, a temporary “image burn” will remain in the image until the next non-uniformity correction. This “image burn” is temporary and is not a defect or sign of permanent damage.



17. PHOTOGRAPHY AND VIDEO RECORDING

The RICO Mk2 is equipped with video recording and image capture. All videos and photos are automatically saved to the built-in 32 GB memory storage.

NOTE: Photo and video files are named with the time and date; therefore, it is recommended to set the date and time before using the photo and video functions. See **Settings Menu > Date and Time** on page 43. Alternatively, the date and time may be synchronized in the InfiRay Outdoor App.

Photography

To take a photo:



1. From the home screen, short press the **Down**  **Button**.
2. The camera  icon will appear briefly in the upper-left corner of the screen to indicate a photo was taken.

NOTE: A red warning icon  appears next to the camera icon in the upper-left corner of the screen when insufficient memory storage is available. Transfer video and image files to other storage media to free up space on the memory card.



Video Recording

To record video:

1. Turn on the microphone in the main menu if desired. See **Main Menu > Microphone** on page 38.
2. From the home screen, long press the **Down  Button** to start a video recording.
3. When the video recording starts, the recording timer, in HH:MM:SS (hour, minute, second) format, appears in the top status bar.
4. When recording, short press the **Down  Button** to take a photo.
5. Long press the **Down  Button** to stop and save the video recording.



Recoil Activated Video Recording

When recoil activated video is turned on in the main menu, a video is automatically recorded when a shot is taken. The RICO Mk2 will record 3 seconds before the shot and 2 minutes and 57 seconds after the shot.

The recoil activated video

 icon appears in the top status bar when RAV is turned on. The video

recording timer, in HH:MM:SS (hour, minute, second) format, will appear next to the RAV icon when video is recording. See **Main Menu > Recoil Activated Video** on page 38 for instructions.



NOTES:

- When multiple shots are taken within the same 30-second period, only one video will be taken.
- When recoil activated video recording is turned on, standard video recording is unavailable.

Video and Photography Notes

- You may enter and navigate the menu during video recording. The user interface (the status bar, icons, and menu) is captured in recorded video or photo files.
- Recorded photos and videos are saved to the memory card.
 - Photos are saved as PIC_HHMMSS.jpg.
 - Videos are saved as VID_HHMMSS.mp4 or RAV_HHMMSS.mp4.
 - HHMMSS is hour, minute, second.
- The maximum duration of a recorded video file is 5 minutes. After this time, video recording will begin a new file automatically.
- The number of recorded files is limited only by the capacity of the internal memory.
- Regularly check the available memory storage space and move video footage and images to other storage media to free up space on the memory card.

18. ACCESSING THE INTERNAL MEMORY

When the RICO Mk2 is turned on and connected to a computer via the included data cable, it is recognized by the computer as a flash memory (USB) drive. This allows the user to access the saved multimedia files and copy or delete any desired files.

To access the internal memory:

1. Turn on the RICO Mk2.
2. Connect the RICO Mk2 to your computer via the included magnetic charging cable (17) or the USB-C cable (16).
3. Double-click **My Computer** on your computer desktop.
4. Double-click to open the device named Inifiray.
5. Double-click to open the device named RH50R to access the built-in memory.
 - a. Recorded photos and videos are separated into folders by date, YYYYDDMM.
6. Select the desired files or folders to copy or delete.

19. USING THE INFIRAY OUTDOOR APP

The RICO Mk2 can be operated using the InfiRay Outdoor App when connected to a tablet or smartphone or via Wi-Fi.



1. Download the App for free and install it on your device:
 - a. Scan a QR code to download it from the App Store or Google Play; **OR**
 - b. Download the App from any app store.
2. Connect the RICO Mk2 to Wi-Fi:
 - a. Turn on the Wi-Fi. See **Main Menu > Wi-Fi** on page 36 for instructions.
 - b. Open the App and press the **ViewFinder**  icon on the home screen. Then, click the **Connect Device WiFi** button.
 - c. On the mobile device, go to **Settings > Wi-Fi**.
 - d. Select the RICO Mk2 from the list of Wi-Fi networks. It will appear in the list as "RH502_YYYYY_XXXXXXXX," where XXXXXXXX is the eight-digit device serial number.
 - e. Enter the Wi-Fi password and tap the **Join** button. The default password is 12345678.
3. Operate the RICO Mk2 via the App:
 - a. Take real-time photos and videos, with or without audio.
 - b. View, share, download, and delete photos and videos taken via the App, which are saved to the mobile device.
 - c. Change the Wi-Fi password and SSID.
 - d. Synchronize the date and time from the mobile device.
 - e. Update the RICO Mk2 firmware.

NOTE: When a factory reset is performed, the Wi-Fi SSID and password are reset to the defaults, RH502_YYYYY_XXXXXXXX and 12345678. See **Settings Menu > Factory Reset** on page 45.

20. INTEGRATED LASER RANGEFINDER

The RICO Mk2 is equipped with an integrated, precision laser rangefinder which allows the user to measure the distance to objects up to 1200 yards away, with ± 1 -yard accuracy. The laser rangefinder has two ranging modes: continuous and single-measurement capture. Continuous ranging allows the user to adjust quickly to changing distances for better shot placement.





CAUTION: Do not stare directly into the laser.





The rangefinder interface has the following features:

- 1 Cursor:** The blue rangefinder cursor  appears in the center of the screen.
- 2 Mode:** Shows the selected ranging mode, CONT (continuous) or SGL (single).
- 3 Ranging Measurement:** Shows the target distance.

To use continuous rangefinder mode:

1. Short press the **Up**  **Button** to turn on the laser rangefinder and enter single ranging mode.
2. Locate the target.
3. The distance to the target indicated by the cursor will be refreshed automatically by the rangefinder every second.
4. Short press the **Power**  **Button** to exit the laser rangefinder.

To use single rangefinder mode:

1. Long press the **Up**  **Button** to turn on the laser rangefinder and enter single ranging mode.
2. Locate the target.
3. Short press the **Up**  **Button** to take a ranging measurement.
4. Long press the **Up**  **Button** to switch from single to continuous ranging.
5. Short press the **Power**  **Button** to exit the laser rangefinder.

NOTE: The rangefinder interface times out after 15 seconds in single-measurement mode.

ACCURACY NOTES:

- The measurement accuracy and maximum range depend on the reflection ratio on the target surface, the angle at which the laser beam falls on the target surface, and environmental conditions. Reflectivity depends on the surface texture, color, size, and shape of the object. Typically, a glossy, bright surface will have higher reflectivity than a darker surface.
- Ranging performance can degrade in bright conditions or when ranging towards the sun.
- The measurement accuracy can be affected by fog, smog, heavy rain, snow, and other weather conditions. It can also be affected by a low battery or a dirty or smudged objective lens.
- Measuring the range to a small target is more difficult than measuring the range to a large target.

21. DIGITAL ZOOM

The RICO Mk2 will quickly increase the base magnification by enlarging the image from 1 to 4 times digitally.

To use digital zoom:

1. From the home screen, rotate the zoom lever (7) clockwise to zoom in or counterclockwise to zoom out on the observed object.
2. The real-time amplification, 3×–12× in increments of 0.1×, appears in the bottom status bar.



22. ULTRA-CLEAR MODE

Ultra-Clear mode improves the image quality in inclement weather conditions, such as rain, fog, high humidity, or high temperatures as these conditions all result in lower thermal contrast. Ultra-Clear mode enhances the NETD value of the thermal sensor and improves the sensor's response rate to these challenging environment conditions. See **Main Menu > Ultra-Clear** on the next page.

Ultra-Clear mode provides:

- Improved image quality and clarity; images are crisper and sharper.
- Increased image detail.
- Improved recognition of observed targets.

23. MAIN MENU OPTIONS AND DESCRIPTIONS

Menu and submenu options, from left to right are:









- **Main Menu:** Ultra-Clear, Reticle, Zeroing, Wi-Fi, PIP, Calibration, Recoil Activated Video, Microphone, Motion Sensor, Standby, Brightness, Pixel Defect Correction, Settings.
 - **Reticle Menu:** Zeroing Profile, Reticle Type, Reticle Color.
 - **Zeroing Menu:** Reticle Zeroing, Customize Zero Distance, Delete Distance.
 - **Settings Menu:** Date, Time, Unit, Languages, Factory Reset, Info.

Menu option details, descriptions, and navigation instructions are listed in order on the following pages.

Ultra-Clear

Turn Ultra-Clear mode on / off

When Ultra-Clear mode is turned on, the image contrast is enhanced, which is suitable for rainy, foggy, or low-contrast conditions.





1. Long press the **Menu**  **Button** to enter the main menu.
2. Short press the **Up**  or **Down**  **Button** to select the Ultra-Clear  menu item.
3. Short press the **Menu**  **Button** to turn Ultra-Clear on / off.
4. The Ultra-Clear status, on  or off , appears in the bottom status bar.
5. Long press the **Menu**  **Button** to return to the home screen.



NOTE: When Ultra-Clear mode is turned on and off, the RICO Mk2 will automatically perform a shuttered non-uniformity correction.

Reticle





Select the zeroing profile, reticle type, and reticle color

1. Long press the **Menu**  **Button** to enter the main menu.
2. Short press the **Up**  or **Down**  **Button** to select the reticle  menu item.
3. Short press the **Menu**  **Button** to enter the reticle submenu.
4. There are three submenu items: zeroing profile, reticle type, and reticle color.



RETICLE MENU > ZEROING PROFILE





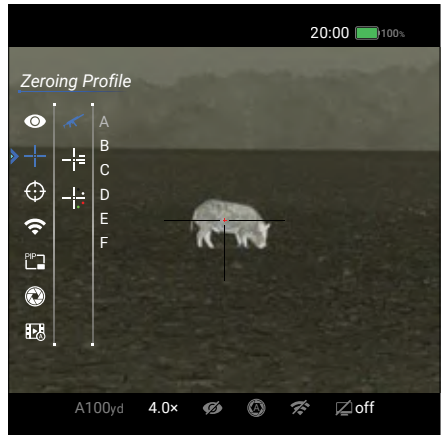

Select the zeroing profile

1. In the reticle submenu, the zeroing profile  menu item is selected by default.
2. Short press the **Menu**  **Button** to enter the zeroing profile submenu.
3. Short press the **Up**  or **Down**  **Button** to move through zeroing profile options, A, B, C, D, E, or F.
4. The selected zeroing profile appears in the bottom status bar.
5. Long press the **Menu**  **Button** to confirm the selection and return to the home screen.



RETICLE MENU > RETICLE TYPE

Select the reticle type

1. In the reticle submenu, short press the **Up**  or **Down**  **Button** to select the reticle type  menu item.
2. Short press the **Menu**  **Button** to enter the reticle type submenu.
3. Short press the **Up**  or **Down**  **Button** to move through reticle type options, 1–7 (see below). The reticle changes as the cursor moves through the reticle types. A custom reticle is also available for purchase in the InfiRay Outdoor App.
4. Long press the **Menu**  **Button** to confirm the selection and return to the home screen.

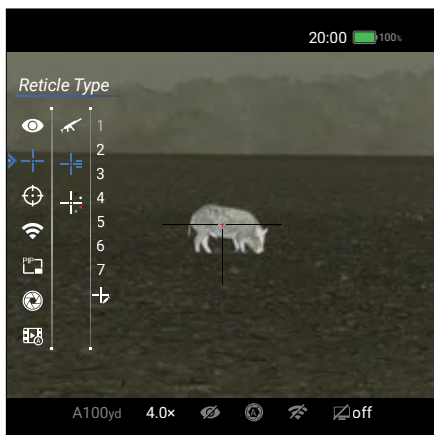



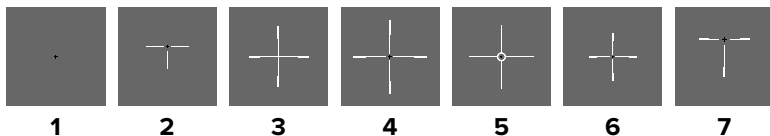



Reticle Types



RETICLE MENU > RETICLE COLOR

Select the reticle color

1. In the reticle submenu, short press the **Up**  or **Down**  **Button** to select the reticle color  menu item.
2. Short press the **Menu**  **Button** to enter the reticle color submenu.
3. Short press the **Up**  or **Down**  **Button** to move through reticle color options, black red, black green, white red, white green, black white, white black, crimson, or viridian. The reticle color changes as the cursor moves through the color options.
4. Long press the **Menu**  **Button** to confirm the selection and return to the home screen.







Zeroing

Select or customize a zero distance

In the zeroing menu, you can add a new zero distance or select a zero distance in the list to edit it, delete it, or adjust the reticle position. The RICO Mk2 supports up to 10 zero distances.





NOTE: Before selecting or adding a new zero distance, you must select a zeroing profile, A, B, C, D, E, or F. See **Reticle Menu > Zeroing Profile** on page 29.

1. Long press the **Menu**  **Button** to enter the main menu.
2. Short press the **Up**  or **Down**  **Button** to select the zeroing  menu item.
3. Short press the **Menu**  **Button** to enter the zeroing submenu.

ZEROING MENU > ZERO DISTANCE SUBMENU

Add or select a zero distance

To add a new zero distance:

1. In the zeroing menu, short press the **Up**  or **Down**  **Button** to move to the add  icon.
2. Short press the **Menu**  **Button** to add a new zero distance. A blue arrow will appear above and below the far-left digit to mark the cursor location.
3. Short press the **Up**  or **Down**  **Button** to increase or decrease the value of the selected digit from 0–9.



4. Short press the **Menu** **[M]** **Button** to switch between the three digits. The two blue arrows move to indicate the selected digit.
5. Short press the **Power** **[⏻]** **Button** to return to the previous menu without saving changes; **OR**
6. Long press the **Menu** **[M]** **Button** to save the new zero distance and return to the home screen.

To select a zero distance:

1. In the zeroing menu, short press the **Up** **[▲]** or **Down** **[▼]** **Button** to select a zero distance.
2. Short press the **Menu** **[M]** **Button** to enter the submenu for the selected zero distance.
3. In the submenu for the selected zero distance, you may:
 - a. Select the reticle zeroing **[🎯]** menu item to adjust the X/Y position of the reticle. See **Reticle Zeroing** below.
 - b. Select the zero distance to edit it. See **Zeroing Menu > Customize Zero Distance** on page 35.
 - c. Select the delete **[🗑️]** menu item to delete it. See **Zeroing Menu > Delete Distance** on page 36.



ZEROING MENU > ZERO DISTANCE SUBMENU > RETICLE ZEROING **[🎯]**

Adjust the reticle position of the selected zero distance

In the reticle zeroing interface, the X/Y position of the reticle may be adjusted to match the point of impact.

1. In the submenu for the selected zero distance, the reticle zeroing **[🎯]** menu item is selected by default. Short press the **Menu** **[M]** **Button** to select and enter the reticle zeroing interface.



2. The reticle zeroing interface has the following features:

1 Y-Axis \updownarrow Icon:

Vertical point of impact change (in cm or inches).

2 X-Axis \leftrightarrow Icon:

Horizontal point of impact change (in cm or inches).

3 Zoom \oplus Icon:

Select to change the zoom level.

4 Freeze \star Icon: Select to freeze the image. When frozen, the icon turns from white to blue. Select a second time to unfreeze the image.

5 Reticle: Shows the new reticle position.

6 Red Cursor: Indicates the center of the original reticle position.



3. In the submenu for the selected zero distance, center the reticle on the aiming point and freeze the image view.

a. Short press the **Down \blacktriangledown Button** to move to the image freeze \star icon. The cursor position is indicated by a blue arrow \blacktriangleright icon.

b. Short press the **Menu \square Button** to freeze the image. The freeze icon will turn from white to blue.





4. Adjust the zoom level, as needed:

a. Short press the **Up \blacktriangle** or **Down \blacktriangledown Button** to move to the zoom \oplus icon.

b. Short press the **Menu \square Button** to select it.

c. Short press the **Up \blacktriangle** or **Down \blacktriangledown Button** to zoom in or out. The selected real-time amplification appears in the bottom status bar, 3.0x, 6.0x, 9.0x, or 12.0x.

5. Select the axis (X or Y) along which to move the reticle:



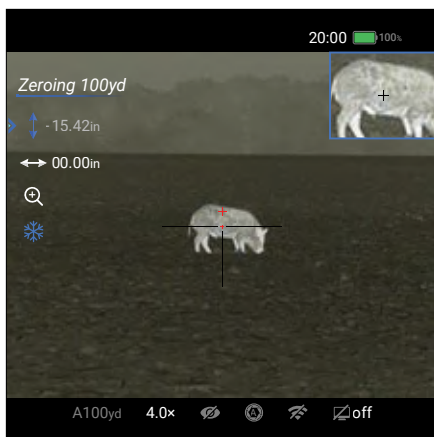

- Short press the **Up**  or **Down**  **Button** to move between X and Y.
- Short press the **Menu**  **Button** to select the desired axis. The selected axis will change from white to blue.





6. Adjust the X/Y position of the reticle until the reticle matches the point of impact.

- X (horizontal) is the windage and Y (vertical) is the elevation.
- Upon moving the reticle, a red curse appears onscreen, representing the original position of the reticle.











- Use the **Up**  **Button** to move in the positive direction: X= Right and Y= Up.
 - Use the **Down**  **Button** to move in the negative direction: X= Left and Y= Down.
 - Short press the **Up**  or **Down**  **Button** to move the reticle in the corresponding direction by 1 pixel; long press to move 10 pixels.
 - When adjusting your zero at a distance of 50 yards, a short press will change the impact point by 0.22", and a long press moves 2.16" as shown in the X and Y coordinate displays. At 100 yards that same short press moves 0.43" and a long press moves 4.32". At 200 yards a short press moves 0.86" and a long press moves 8.64".
 - The distance of your X/Y adjustments will update automatically if you change your zero distance, for example from 100 to 200 yards.
7. Short press the **Menu**  **Button** to save the position for the selected axis and deselect it. When deselected, the axis will change from blue to white.

- Repeat steps 5–7 to adjust the reticle position along the second axis if needed.
- Short press the **Power**  **Button** to exit the interface without saving the reticle position; **OR**
- Long press the **Menu**  **Button** to save the reticle position for both axes and return to the home screen.
- “Data saving” will appear at the bottom of the screen and the system will exit to the homepage.
- Take a confirmation shot—the point of impact should now match the point of aim. If not, adjust the X/Y position of the reticle again.

ZEROING MENU > ZERO DISTANCE SUBMENU > CUSTOMIZE ZERO DISTANCE









Edit a selected zero distance

- In the submenu for the selected zero distance, short press the **Up**  or **Down**  **Button** to move to the zero distance.
- Short press the **Menu**  **Button** to edit the selected zero distance. A blue arrow will appear above and below the far-left digit to mark the cursor location.
- Short press the **Up**  or **Down**  **Button** to increase or decrease the value of the selected digit from 0–9.
- Short press the **Menu**  **Button** to switch between the three digits. The two blue arrows move to indicate the selected digit.
- Short press the **Power**  **Button** to return to the previous menu without saving changes; **OR**
- Long press the **Menu**  **Button** to save the edited zero distance and return to the previous menu.



ZEROING MENU > ZERO DISTANCE SUBMENU > DELETE DISTANCE

Delete the selected zero distance



1. In the submenu for the selected zero distance, short press the **Up**  or **Down**  **Button** to move to the delete  icon.
2. Short press the **Menu**  **Button** to delete the selected distance.
3. A popup window shows the message “Delete this distance?” and two options, No and Yes. No is selected by default.
4. Short press the **Menu**  **Button** to select **No** to return to the previous menu without deleting the zero distance; **OR**
5. Short press the **Up**  or **Down**  **Button** to select **Yes** and short press the **Menu**  **Button** to delete the zero distance and return to the previous menu.





Wi-Fi

Turn Wi-Fi on / off

Turn on Wi-Fi to manipulate the RICO Mk2 via the InfiRay Outdoor App.



1. Long press the **Menu**  **Button** to enter the main menu.
2. Short press the **Up**  or **Down**  **Button** to select the Wi-Fi  menu item.



3. Short press the **Menu** **M** **Button** to toggle Wi-Fi on / off. The Wi-Fi status, on  or off , appears in the status bar.
4. Long press the **Menu** **M** **Button** to return to the home screen.

Picture in Picture



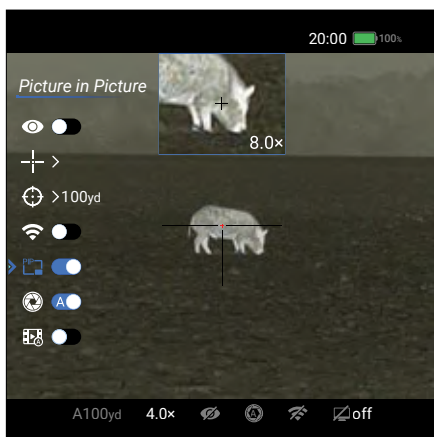

Turn the picture-in-picture window on / off

1. Long press the **Menu** **M** **Button** to enter the main menu.
2. Short press the **Up**  or **Down**  **Button** to select the picture-in-picture  menu item.
3. Short press the **Menu** **M** **Button** to toggle the PIP window on / off. When turned on, the PIP window appears at the top of the screen and displays a 2× zoomed image.
4. Long press the **Menu** **M** **Button** to return to the home screen.



Calibration Mode

Set the non-uniformity correction mode to automatic or manual







1. Long press the **Menu** **M** **Button** to enter the main menu.
2. Short press the **Up**  or **Down**  **Button** to select the calibration mode  menu item.
3. Short press the **Menu** **M** **Button** to toggle between the two options: A (automatic) and M (manual).
4. The selected NUC mode,  or , appears in the status bar.
5. Long press the **Menu** **M** **Button** to return to the home screen.



Recoil Activated Video

Turn recoil activated video on / off

When recoil activated video is turned on, the rifle scope will record 3 seconds before the shot and 2 minutes and 57 seconds after the shot.

1. Long press the **Menu**  **Button** to enter the main menu.
2. Short press the **Up**  or **Down**  **Button** to select the recoil activated video  menu item.
3. Short press the **Menu**  **Button** to toggle recoil activated video on / off. The recoil activated video  icon appears in the top status bar when RAV is turned on. The video recording timer, in HH:MM:SS (hour, minute, second) format, will appear next to the RAV icon when video is recording.
4. Long press the **Menu**  **Button** to confirm the selection and return to the home screen.









NOTES:

- When multiple shots are taken within the same 30-second period, only one video will be taken.
- When recoil activated video recording is turned on, standard video recording is unavailable.

Microphone







Turn the microphone on / off

1. Long press the **Menu**  **Button** to enter the main menu.
2. Short press the **Up**  or **Down**  **Button** to select the microphone  menu item.
3. Short press the **Menu**  **Button** to turn the microphone on / off.
4. When on, the microphone  icon appears in the lower-right corner of the screen.
5. Long press the **Menu**  **Button** to return to the home screen.



Motion Sensor

Turn the motion sensor on / off

1. Long press the **Menu  Button** to enter the main menu.
2. Short press the **Up  or Down  Button** to select the motion sensor  menu item.
3. Short press the **Menu  Button** to toggle the motion sensor on / off. When on, the tilt angle appears on the left side of the screen and the pitch angle appears on the right side of the screen.
4. Long press the **Menu  Button** to return to the home screen.



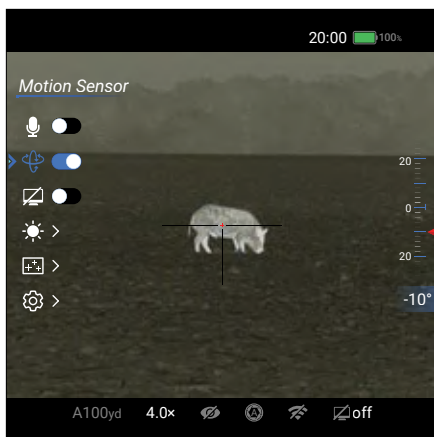



NOTE: The tilt angle is not shown in the figure above because it is hidden by the menu.



Standby

Turn on automatic standby mode

The RICO Mk2 may be set to automatically enter standby mode.

1. Long press the **Menu  Button** to enter the main menu.
2. Short press the **Up  or Down  Button** to select the standby  menu item.
3. Short press the **Menu  Button** to toggle auto standby on / off. When turned on, the RICO Mk2 will automatically enter standby after about 5 seconds.
4. Long press the **Menu  Button** to confirm the selection and return to the home screen.

NOTES:





- When auto standby mode is turned on:
 - The RICO Mk2 will enter standby automatically when it is tilted up or down at an angle of more than 70° or left or right at an angle of more than 30°.



- The RICO Mk2 will not enter standby mode while it is in a level firing position.
- Press any button to exit auto standby.
- When auto standby is turned off, the rifle scope will operate until the batteries run out.

Brightness

Adjust the screen brightness





1. Long press the **Menu**  **Button** to enter the main menu.
2. Short press the **Up**  or **Down**  **Button** to select the brightness  menu item.
3. Rotate the zoom lever (**7**) right or left to adjust the screen brightness level, from 0–100%.
4. Long press the **Menu**  **Button** to confirm the selection and return to the home screen.



Pixel Defect Correction

Correct defective pixels

Defective pixels are pixels that do not change correctly compared to the other image pixels—they are either brighter or darker than surrounding pixels. The RICO Mk2 has a tool that corrects defective pixels on the sensor using its internal software.

1. Long press the **Menu**  **Button** to enter the main menu.
2. Short press the **Up**  or **Down**  **Button** to select the pixel correction  menu item.

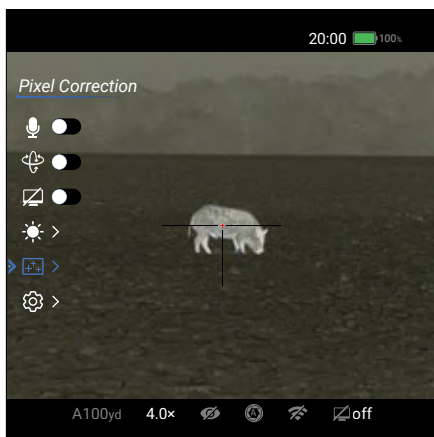

3. Short press the **Menu**

M **Button** to enter the pixel correction interface.

4. The interface has the following features:

1 Pixel Cursor

+: Appears in the center of the screen in place of the reticle. Move the cursor to the position of the defective pixel.

2 PIP Window:

Appears in the lower-left corner.

3 Navigation Cursor **>** **Icon:** Shows the cursor position in the interface.

4 X-Axis **↔** **Icon:** Select to move the pixel cursor horizontally.

5 Y-Axis **↑↓** **Icon:** Select to move the pixel cursor vertically.

6 Add **⊕** **Icon:** Select to add a defective pixel to the “to be corrected” list.

7 Automatic Pixel Correction **⊕+** **Icon:** Select to automatically correct all defective pixels.

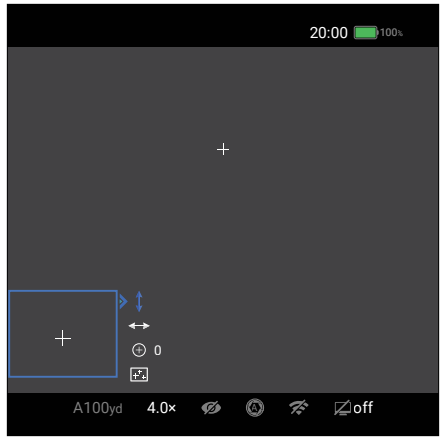

To auto-correct defective pixels:

1. Short press the **Up** **▲** or **Down** **▼** **Button** to move to the automatic pixel correction **⊕+** icon.

2. Short press the **Menu** **M** **Button** to correct all defective pixels automatically.

NOTE: If the algorithm fails to locate all defective pixels, it may be necessary to manually correct additional pixels.



To manually select and correct defective pixels:

1. Select the axis (X or Y) along which to move the cursor:



a. Short press the **Up** **▲** or **Down** **▼** **Button** to move between **X** and **Y**. The cursor position is indicated by a blue arrow **>** icon.

b. Short press the **Menu** **M** **Button** to select X or Y. The selected axis will change from white to blue.

2. Move the cursor along the selected axis to the location of the defective pixel:

a. Use the **Up**  **Button** to move in the positive direction: X= Right and Y= Up.

b. Use the **Down**  **Button** to move in the negative direction: X= Left and Y= Down.

c. Short press the **Up**  or **Down**  **Button** to move the cursor in the corresponding direction by 1 pixel; long press to move 10 pixels.

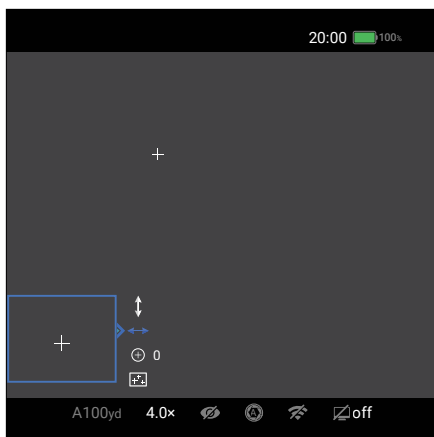



3. Short press the **Menu**  **Button** to save the position for the selected axis and deselect it. When deselected, the axis will change from blue to white.

4. Move to and select the second axis and adjust the cursor position, as needed.

5. Add the pixel to the “to be corrected” list:

a. With the cursor in position, short press the **Menu**  **Button** to deselect the axis of movement.



b. Press the **Up**  or **Down**  **Button** to move to the add  icon.

c. Short press the **Menu**  **Button** to add the pixel. The number of pixels to the right of the add icon will increase to indicate that one pixel has been added to the list.

d. If the defective pixel has been added in error, short press the **Menu**  **Button** a second time from the same X/Y coordinates (do not move the cursor) to remove the pixel from the “to be corrected” list. The number of pixels shown to the right of the add icon will decrease to indicate the pixel has been removed.

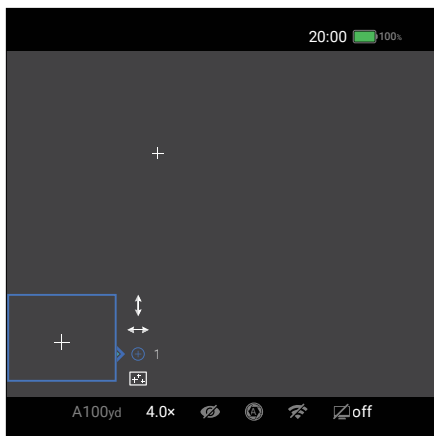
6. Repeat steps 1–5 to add additional defective pixels as needed.





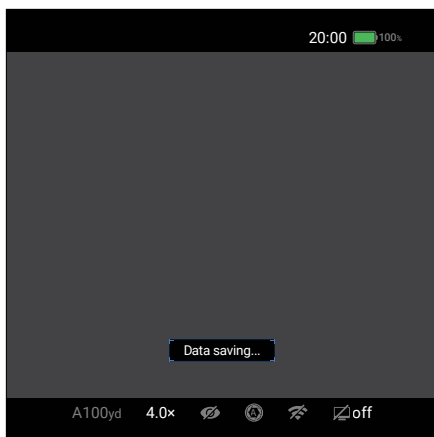

- Short press the **Power**  **Button** to exit the interface without saving; **OR**
- When all defective pixels have been added to the list, long press the **Menu**  **Button** to confirm changes.
- “Data saving..” will appear at the bottom of the screen and the system will exit to the home screen.



NOTES: The PIP window and interface controls move to the upper-left corner when the cursor moves into the lower-left corner.









Settings Menu

Adjust the general settings

- Long press the **Menu**  **Button** to enter the main menu.
- Short press the **Up**  or **Down**  **Button** to select the settings  menu item.
- Short press the **Menu**  **Button** to enter the settings submenu.

SETTINGS MENU > DATE









Set the date

- In the settings submenu, short press the **Up**  or **Down**  **Button** to select the date  menu item.
- Short press the **Menu**  **Button** to edit the date. A blue arrow will appear above and below the year digit. The date is displayed in YYYY.MM.DD format.
- Short press the **Up**  or **Down**  **Button** to select the correct value for each digit (year, month, and day).
- Short press the **Menu**  **Button** to switch between digits. The two arrows move to indicate the selected digit.
- Long press the **Menu**  **Button** to save the date and return to the home screen.



SETTINGS MENU > TIME







Set the time

1. In the settings submenu, short press the **Up**  or **Down**  **Button** to select the time  menu item.
2. Short press the **Menu**  **Button** to edit the time. A blue arrow will appear above and below the hour digit. The time is displayed in HH.MM, in 24-hour format.
3. Short press the **Up**  or **Down**  **Button** to select the correct value for each digit (hour and minute).
4. Short press the **Menu**  **Button** to switch between digits. The two arrows move to indicate the selected digit.
5. Long press the **Menu**  **Button** to save the time and return to the home screen.
6. The time appears in the status bar.



SETTINGS MENU > UNIT





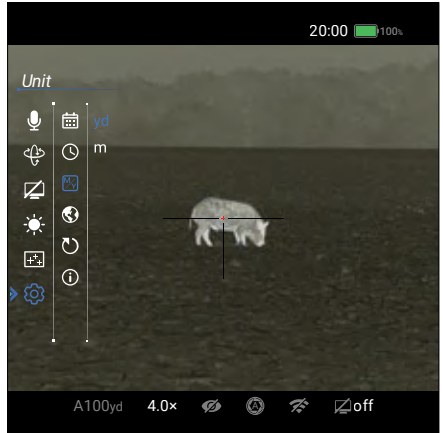

Set the units of measurement

1. In the settings submenu, short press the **Up**  or **Down**  **Button** to select the unit  menu item.
2. Short press the **Menu**  **Button** to enter the submenu.
3. Short press the **Up**  or **Down**  **Button** to move through unit options, meters and yards. The selected units, m (meters) or y (yards), display along with the selected zero profile and distance in the bottom status bar.
4. Long press the **Menu**  **Button** to confirm the selection and return to the home screen.



SETTINGS MENU > LANGUAGES









Select the languages

1. In the settings submenu, short press the **Up**  or **Down**  **Button** to select the languages  menu item.
2. Short press the **Menu**  **Button** to enter the submenu.
3. Short press the **Up**  or **Down**  **Button** to move through the language options.
4. Long press the **Menu**  **Button** to confirm the selection and return to the home screen.



SETTINGS MENU > FACTORY RESET

Restore factory default settings

1. In the settings submenu, short press the **Up**  or **Down**  **Button** to select the factory reset  menu item.
2. Short press the **Menu**  **Button** to enter the factory reset submenu.
3. Two options, Yes and No, appear; Yes will restore factory settings and No will cancel the operation. No is selected by default.
4. Short press the **Menu**  **Button** to select **Yes** to confirm the factory reset. Factory settings will be restored and the RICO Mk2 will reboot automatically; **OR**
5. Short press the **Up**  or **Down**  **Button** to select **No** and short press the **Menu**  **Button** to confirm cancellation of the factory reset and return to the submenu.

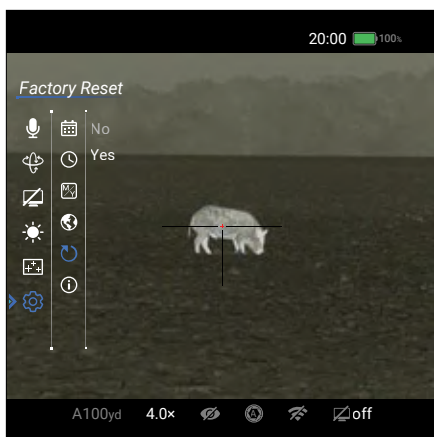

FACTORY RESET NOTES:

- The screen will go dark and the factory restart will begin after a pause of about 20 seconds.
- A factory reset cannot be undone.
- The settings listed below will be reset to the factory defaults:
 - Color Palette: White Hot
 - Image Sharpness: 5
 - Image Brightness: 5
 - Image Contrast: 5
 - Magnification: 3×
 - Ultra-Clear mode: Off
 - Wi-Fi: Off
 - Calibration: Automatic
 - Motion Sensor: Off
 - Zeroing Profile: A
 - Reticle Type: 1
 - Reticle Color: Black Red
 - Microphone: Off
 - Standby: Off
 - Screen Brightness: 50%
 - Language: English
 - Unit: Meters
 - Wi-Fi Password: 12345678
 - Wi-Fi SSID: RH502_YYYYY_XXXXXXXXX

SETTINGS MENU > INFO ⓘ

Show device information

1. In the settings submenu, short press the **Up ▲** or **Down ▼** **Button** to select the info ⓘ menu item.
2. Short press the **Menu M** **Button** to enter the submenu.
3. The info submenu will display the following information about the RICO Mk2: the model number, the GUI, FPGA, boot, kernel, root, and hardware versions, the part and serial numbers, and the FCC ID.
4. Long press the **Menu M** **Button** to save and return to the home screen.



24. BASIC INSPECTION

It is recommended to carry out a technical inspection before each use. Please check the following:

- The rifle scope appearance: there should be no cracks in the body or visible damage.
- The condition of the objective lens and eyepiece: there should be no cracks, greasy spots, dirt, or other deposits on the lens.
- The internal rechargeable battery pack should be fully charged.
- The control buttons should be in working order.

25. BASIC MAINTENANCE

Always replace the objective lens cap **(1)** after use to avoid damaging or scratching the lens. Never touch the lens directly; oil from your skin can damage the lens coating and surface.

Basic maintenance should be carried out at least twice a year and includes the following steps:

- Wipe the surface of the external metal and plastic components with a clean, dry cotton cloth. Do not use chemical, corrosive, or abrasive cleaners. Canned air may also be used to clean the external components.
- Clean the electric contacts and battery slots on the rifle scope using a non-greasy organic solvent.
- Check the lens and eyepiece. If necessary, remove any dirt or sand from the optics; a non-contact cleaning method is preferred.
- Cleaning the exterior of the lens should only be done with the included microfiber lens cloth or a similar product. Only clean the lens when it is visibly soiled. Frequent wiping or cleaning can degrade the anti-reflective lens coating.

26. WARRANTY

At iRayUSA we're first and foremost hunters and users of our products and we understand that failure isn't an option. We also understand that having to wait extended periods for repair isn't something that a customer should have to put up with when something does go wrong. During your published warranty period, iRayUSA will repair or replace, at its discretion, any optic that becomes defective during normal use. Additionally, if we cannot fix your optic in less than one week, we will offer to replace it with a replacement product in like or better condition. If you would rather wait for your specific optic to be repaired, we can handle that too.

We know you've never seen this from a thermal manufacturer and neither have we; that's why we started iRayUSA.

Our warranty follows the product and is not tied to the original owner. The warranty period is tied to the date of sale to the dealer. This warranty only covers normal use and does not cover cosmetic damage, normal wear, intentional damage, theft, loss, any act of God, or a condition caused by use other than intended. Any product that is modified, opened, or tampered with will void any warranty coverage. Any serial number damage or alteration on the product will be considered a modification. Be sure to register your RICO Mk2 rifle scope at irayusa.com/register.

To return a product for repair:

1. Go to irayusa.com/warranty and click the **Request an RMA button** to request an RMA number. Returns will not be accepted without an RMA.
2. The customer is responsible for shipping the product to iRayUSA, per the instructions included with the RMA. iRayUSA will return the product at no cost.

WARRANTY NOTES:

- The one-week timeline starts from the time of receipt of the product at iRayUSA.
- iRayUSA is not liable for any damages or loss incurred when shipping to iRayUSA.
- This warranty gives you specific legal rights, and you may also have other rights which vary from state to state.

Please give us a call at **800-769-7125**, visit irayusa.com/warranty, or email info@irayusa.com with any questions.

27. FCC STATEMENT

FCC ID: 2AYGT-4C-00

This device complies with part 15 of the FCC Rules. Operation is subject to the following two conditions: (1) This device may not cause harmful interference, and (2) this device must accept any interference received, including interference that may cause undesired operation.

CAUTION: Changes or modifications not expressly approved by IRayUSA could void the user's authority to operate the equipment.

NOTE: This equipment has been tested and found to comply with the limits for a Class B digital device, pursuant to part 15 of the FCC Rules. These limits are designed to provide reasonable protection against harmful interference in a residential installation. This equipment generates, uses and can radiate radio frequency energy and, if not installed and used in accordance with the instructions, may cause harmful interference to radio communications. However, there is no guarantee that interference will not occur in a particular installation. If this equipment does cause harmful interference to radio or television reception, which can be determined by turning the equipment off and on, the user is encouraged to try to correct the interference by one or more of the following measures:

- Reorient or relocate the receiving antenna.
- Increase the separation between the equipment and receiver.
- Connect the equipment into an outlet on a circuit different from that to which the receiver is connected.
- Consult the dealer or an experienced radio/TV technician for help.

This device was tested for typical body-supported operations and use. To comply with RF exposure requirements, a minimum separation distance of 0.5cm must be maintained between the user's body and the handset, including the antenna. Third-party belt-clips, holsters, and similar accessories used by this device should not contain any metallic components. Body accessories that do not meet these requirements may not comply with RF exposure requirements and should be avoided. Use only the supplied or an approved antenna.

28. GENERAL TROUBLESHOOTING

The troubleshooting table on the next page lists issues that may occur when operating the RICO Mk2. Carry out the recommended troubleshooting steps in the order shown in the table. Please contact iRayUSA at 800-769-7125 or irayusa.com/support or an authorized vendor for assistance before attempting to perform any modifications or repairs beyond the scope of the troubleshooting procedures in this manual. Unauthorized repairs or modifications will void your warranty.

ISSUE	POSSIBLE CAUSES
The RICO Mk2 will not turn on.	The IBP-5 battery pack is very low or has completely discharged.
The RICO Mk2 can not connect to a computer or external power supply.	External power supply has completely discharged.
	Computer is turned off.
	USB-C or magnetic charging cable is damaged.
The RICO Mk2 can not connect to the mobile device (smartphone or tablet).	Wi-Fi is not turned on.
	Wrong Wi-Fi password entered.
	Too many Wi-Fi signals nearby, which may cause interference.
Wi-Fi signal is lost or interrupted.	The device is out of range of a strong Wi-Fi signal, or there are obstacles (such as concrete walls) between the device and the signal.
The image is blurry, the background is uneven, or vertical lines or artifacts are present.	Non-uniformity correction is required.
The image is too dark.	Screen brightness level is too low.
The GUI is clear, but the image is blurry.	The lens is not focused.
	There is dust or ice on the interior or exterior optical surfaces of the lens.
	There is condensation on the interior or exterior optical surfaces of the lens.
The aiming reticle shifts after firing rounds.	The RICO Mk2 is not mounted securely or the mount is not secured on the RICO Mk2.
Observed target disappears.	Observing the target through glass.
The RICO Mk2 will not focus.	Image settings are not optimal for the current environmental conditions or the object being observed.
Image quality is low or the detection range is reduced.	Environmental conditions, such as snow, rain, humidity, and fog.
When the RICO Mk2 is used in low-temperature conditions, the image quality of the surroundings is worse than in warm-temperature conditions.	Environmental conditions.

TROUBLESHOOTING STEPS

Charge the battery pack.

Check the external power supply and charge it if necessary.

Power on the computer.

Replace the cable.

Turn on the Wi-Fi in the main menu. See **Main Menu > Wi-Fi** on page 36.

On the mobile device, go to **Settings > Wi-Fi** and enter the correct password. The default password is 12345678. See **Main Menu > Wi-Fi** on page 36.

Move the RICO Mk2 and mobile device to an area with no or fewer Wi-Fi signals.

- Try again when the Wi-Fi signal is stable.
- Move the RICO Mk2 closer to the Wi-Fi signal.

Perform a non-uniformity correction. See **Non-uniformity Correction** on page 21 and See **Using the Quick Menu** on page 18.

Adjust the screen brightness in the menu. See **Main Menu > Brightness** on page 40.

- Adjust the focus on the target by rotating the objective focus knob (2).
- Adjust the image sharpness in the quick menu. See **Using the Quick Menu** on page 18.

• Wipe the external optical surface with the included microfiber lens cloth.

- Wipe the external optical surface with the included microfiber lens cloth.
- Allow the RICO Mk2 to dry by leaving it in a warm, dry environment for at least 4 hours.

- Check that the RICO Mk2 has been securely mounted.
- Make sure you are using the same brand, type, and weight of the bullets as when the RICO Mk2 and weapon were initially zeroed.
- If the RICO Mk2 was zeroed in different environmental conditions, a slight shift of the zero is possible.

Remove any glass windows from the field of view.

- Check the external surface of the objective lens and eyepiece and, where necessary, wipe away any dust, condensation, frost, etc.
- In cold weather, you can use special anti-fogging coatings, such as those made for corrective glasses.
- Adjust the focus on the target by rotating the objective focus knob (2).
- Adjust the image sharpness in the quick menu. See **Using the Quick Menu** on page 18.
- Adjust the image and device settings. See **Quick Start Guide** on page 8.
- Turn on Ultra-Clear mode. See **Main Menu > Ultra-Clear** on page 28.

Turn on Ultra-Clear mode. See **Main Menu > Ultra-Clear** on page 28.

In warm-temperature conditions, objects being observed (surroundings and background) heat up differently because of thermal conductivity, thereby generating a high-temperature contrast. Accordingly, image quality produced by the rifle scope will be higher. In low-temperature conditions, the background will cool down to roughly the same temperature, and thus the temperature contrast is substantially reduced and image detail can go down as there is less contrast in the scene. This is a normal function of a thermal imager and is no indicator of actual detector performance.



2601 State Hwy 121,
Building 3, Suite 306
Lewisville, TX 75056
800-769-7125
682-499-0047
info@irayusa.com