



Operating Manual

V2.0

TUBE

**Digital
Night Vision Scope**

TD50L



IRay Technology Co., Ltd.

Add: 11th Guiyang Street, YEDA, Yantai, P.R. China

Tel: 0086-400-999-3800

Email: infiRayoutdoor@infiRay.com

Web: www.infiRayoutdoor.com



IMPORTANT SAFETY INFORMATION

Environmental influences

WARNING! Never point the lens of the device directly at intense heat sources such as the sun or laser equipment. The objective lens and eyepiece can function as a burning glass and damage the interior components. The warranty does not cover damage caused by improper operation.

Risk of swallowing

Caution: Do not place this device in the hands of small children. Incorrect handling can cause small parts to come loose which may be swallowed.

Safety instructions for use

- Handle the device and battery pack with care: rough handling may damage the battery pack.
- Do not expose the device to fire or high temperatures.
- Only use the battery charger included in the delivery package.
- The battery capacity decreases when operated in a cold ambient temperature. This is not a fault and occurs for technical reasons.
- Always store the device in its carrying bag in a dry, well-ventilated space. For prolonged storage, remove the batteries.

- Do not expose your device to extreme temperatures lower than - 20°C and higher than + 50°C.
- The product shall only be connected to a USB Type C interface.
- If the device has been damaged or the battery is defective, send the device to our after-sales service for repair.

Safety instructions for the power supply unit

- Check the power supply unit, cable and adapter for visible damage before use.
- Do not use any defective parts. Defective components must be replaced.
- Do not use the power supply unit in wet or humid environments.
- Only use the original cable provided with the battery charger.
- Do not make any technical modifications.

For further information and safety instructions, please refer to the Operation Instructions provided. This is also available on our website in the download center: www.infrayouther.com.

User information on the disposal of electrical and electronic devices (private households)

The WEEE symbol on products and/or accompanying documents indicates that used electrical and electronic products must not be mixed with ordinary household waste. For proper treatment, recovery and

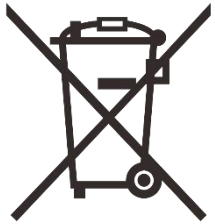

recycling, take these products to the appropriate collection points where they will be accepted without charge. In some countries, it may also be possible to return these products to your local retailer when you purchase a corresponding new product. The proper disposal of this product serves to protect the environment and prevents possible harmful effects on human beings and their surroundings, which

may arise as a result of incorrect handling of waste.

More detailed information on your nearest collection point is available from your local authority. In accordance with state legislation, penalties may be imposed for the improper disposal of this type of waste.

For business customers within the European Union

Please contact your dealer or supplier regarding the disposal of electrical and electronic devices. He will provide you with further information.

Information on disposal in other countries outside of the European Union

This symbol is only applicable in the European Union. Please contact your local authority or dealer if you wish to dispose of this product and ask for a disposal option.

Intended use

The device is intended for displaying heat signatures during nature observation, remote hunting observations and for civil use. This device is not a toy for children.

Use the device only as described in this instruction manual. The manufacturer and the dealer accept no liability for damages which arise due to non-intended or incorrect use.

Function test

- Before use, please ensure that your device has no visible damage.
- Test to see if the device displays a clear, undisturbed image.
- Check that the settings for the thermal imaging riflescope are correct.

See the notes in the section Operation.

Installing/removing the battery

The Tube series thermal imaging riflescope is equipped with two power supply systems – one built-in battery pack and one replaceable 18500 battery. The built-in battery pack cannot be removed.

Observation with and without glasses

Thanks to the flexible eyeshade, the Tube series can be used with or without glasses. It offers a full field of view in both cases.

1 Specifications

| Model | TD50L |
|------------------------------------|---|
| Detector Specifications | |
| Sensor Resolution, pixels | 1440 × 1080 |
| Pixel Size, μm | 4 |
| Frame Rate, Hz | 50 |
| Optical Specifications | |
| Objective Lens, mm | 50F1.2 |
| Field of View, ° | 6.6 × 4.9 |
| Linear Field of View (H×V), m@100m | 11.5 × 8.5 |
| Optical Magnification, × | 4.0 ~ 16.0 |
| Digital Zoom, × | 1 ~ 4 |
| Eye Relief, mm | 70 |
| Diopter Adjustment, D | -4 ~ +4 |
| Detection Range, m | 600 |
| Display Specifications | |
| Type | LCOS |
| Resolution, pixels | 1280 × 960 |
| Battery Power Supply | |
| Battery Type | Built-in 6600mAh battery pack + one replaceable 18500 battery |
| Max. Operating Time (t=22°C) *, h | 13 |

| | |
|---|---------------------------|
| External Power Supply | 5V (Type C) |
| Physical Specifications | |
| Wi-Fi / APP | Support (InfiRay outdoor) |
| Photo / Video Recorder | Support |
| Memory Capacity, GB | 16 |
| IP Rating | IP67 |
| Operating Temperature, °C | -20 ~ +50 |
| Weight (Without the 18500 Battery), g | < 1000 |
| Dimension, mm | 395 × 85 × 75 |
| Body Material | Aluminum |
| Connections and Compatibilities | |
| Max. Recoil Power on Rifled Weapon (Eo), Joules | 6000 |
| Aim Point, MOA | 0.27 (8mm@100m) |
| Mount | Standard 30mm rings |
| Function | |
| IR Illuminator**, nm | 850 / 940 (Optional) |
| IR Type, w | LED |
| IR Power, w | 3 |

* Actual operation time depends on the density of Wi-Fi use and video recording functions.

** The product package does not contain the IR illuminator. Please select 850nm/940nm IR illuminator according to your own needs.

- Improvements may be made to the design and software of this product to enhance its features without prior notice to the customer.

2 Package Contents

- Tube TD50L Digital Night Vision Scope
- Eyeshade
- Mounting for picatinny rail
- IPB-3 portable bag
- USB-C cable
- Power adapter
- Lens cleaning cloth
- Certificate of qualification

3 Description

Tube series digital night vision scope is a daytime and night dual-use scope designed for outdoor hunting. It is equipped with a starlight-level low illuminance chip, which can restore true colors and details in both

day and night. The Tube series has a variety of battery-powered solutions with long operating hours, and can be widely used for hunting, observation and positioning in low visibility conditions. It adopts a 30mm standard pipe diameter to meet the requirements of the general clamp interface.

4 Product Features



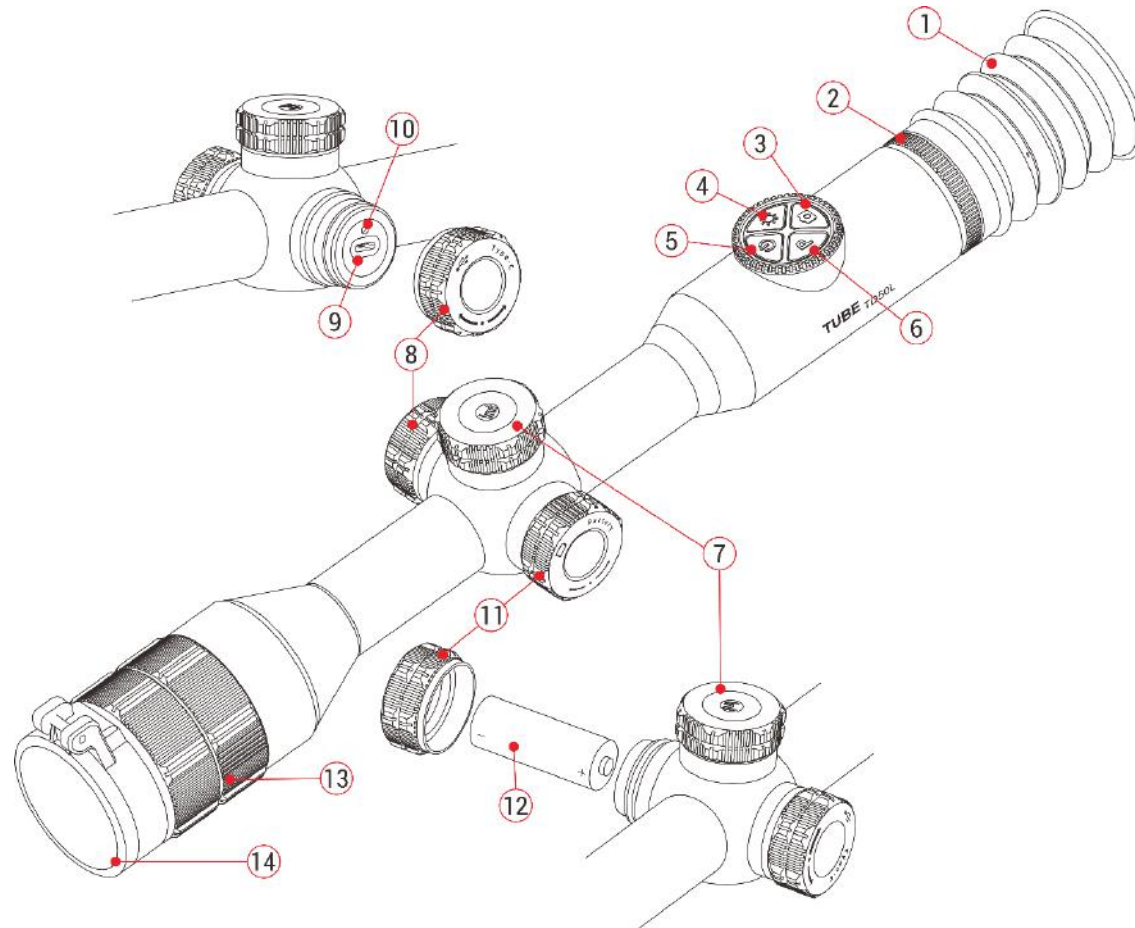

- Starlight low illuminance sensor
- High image quality
- Dual power supply system, with long battery life
- Standard 30mm pipe diameter
- Stadiametric rangefinder
- Long detection distance
- Built-in memory card, supporting photo taking and video recording
- Built-in Wi-Fi module, supporting app connection
- Support PIP function (Due to some factors, this function is not available for some regions)
- Convenient operation interface

5 Components and Controls

1. Eyeshade
2. Eyepiece adjusting ring
3. Camera button
4. Brightness button
5. Power button
6. Palette button
7. Controller
8. USB cover
9. Type-C port
10. LED indicator
11. Extend battery cover
12. 18500 battery
13. Lens focus ring
14. Lens cover

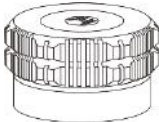

6 Button Description

| Button | Current Status | Short Press | Long Press | Rotate |
|---|-------------------------|---|---|-------------------------------------|
| Power button  | Powered off | — | Power on the device | — |
| | Home screen | Standby the device | Shut down the device | — |
| | Standby | Wake up the device | — | — |
| | Main menu screen | Return to the upper menu without saving changes | — | — |
| Palette button  | Home screen | Switch the image mode | Turn on/off the PIP function | — |
| Brightness button  | Home screen | Adjust the display brightness | Turn on/off the stadiametric rangefinder function | — |
| Camera button  | Home screen | Take a photo | Start / Stop video recording | — |
| Controller  | Home screen | Open the shortcut menu function | Open the main menu function | Adjust the magnification |
| | Shortcut menu interface | Switch menu options | Save and back to the home screen | Adjust the parameters of a function |
| | Main menu interface | Confirm selection / Enter the submenu | Save and back to the main | Switch menu options |

| | | | | |
|--|-------------------|---|----------------|---|
| | Zeroing interface | Switch movement direction between X axis and Y axis | menu interface | Move reticle position: Clockwise: move to the left / down Anticlockwise: move to the right / up |
|--|-------------------|---|----------------|---|

7 Power Supply

The Tube series adopts a dual power system (built-in chargeable Lithium-ion battery pack and a replaceable 18500 battery). The normal working time of the dual power supply system can be up to 13 hours. Also, Tube series can support the USB power supply. Please notice that the battery should be fully charged before first use.

Charging the Built-in Battery

During use, if the built-in battery icon turns into , it indicates that the battery level is low. Please charge the battery in time to avoid reducing the service life of the device due to over discharge of the battery.

- Rotate the USB cover (8) counterclockwise and remove it.

- Connect the Type-C end of the attached data cable (15) to the Type-C port (9) on the Tube series.
- Connect the other end of the data cable (15) to the USB port on the power adapter (16). Plug the adapter (16) into a 100-240V power socket (17) for charging.

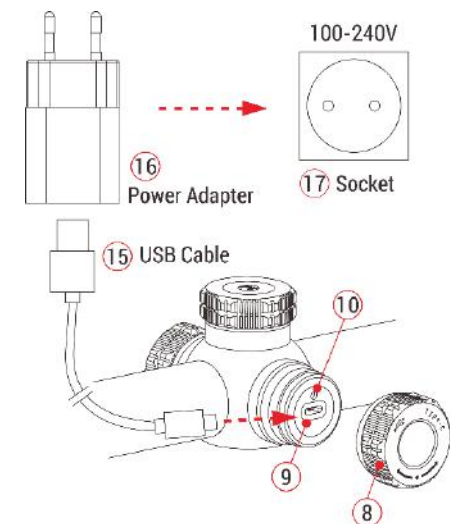

- During charging, a charging icon  appears on the right of the battery icon, and the LED indicator on the device is red. When the indicator turns green, it indicates that charging is complete.

Note: The USB port can only be used for charging the built-in battery pack.

Installing 18500 battery

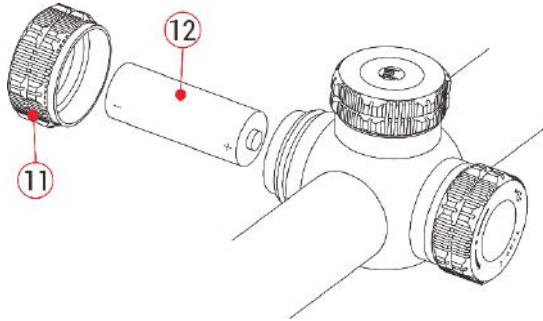

- Turn the battery cover **(11)** counterclockwise and remove it.
- Install the 18500 battery **(12)** into the battery compartment along the special label in the battery compartment designed for it, that is, the positive pole faces inward and the negative pole faces outward.
- Close and tighten the battery cover **(11)** by turning it clockwise.

Switching between the two batteries

- If both batteries are installed in the Tube device, two battery icons are displayed on the right of the status bar below the image, with the replaceable battery icon on the left and the built-in battery icon on the right. The battery from which the device is powered is displayed in green, inactive - in gray.

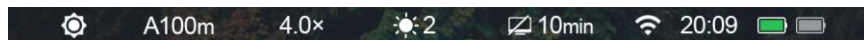

- If there is no replaceable battery in the device, only the green icon of the built-in battery is displayed on the right.
- If the both batteries are fully charged, the replaceable battery will be preferred to power the device. If the replaceable battery level is low, the device will switch to the built-in battery automatically.
- When connecting to the external power supply using the USB port **(9)**, it will switch to the external power supply automatically. At this time, a lightning charging icon is displayed above the built-in battery icon on the right of the display, which indicates that the built-in battery is being charged.
- When the device is in use, it is possible to change the replaceable battery without powered on. At this time, it will switch to the internal battery automatically.

Safety Measures

- When charging, always use the 5V2A power adapter compatible with the device. Using any other type of adapter may cause irreversible damage to the battery or the adapter itself.
- If the device is not in use for a long time, the battery should be partially charged, not fully charged or discharged.

- Do not charge the device immediately after it is moved to a warm environment from a cold environment. Wait for 30 to 40 minutes for preheating.
- If the charger is modified or damaged, do not use it.
- The device should be charged at a temperature of 0°C to +40°C. Otherwise, the battery life will be significantly reduced.
- When charging, please do not leave the battery unattended.
- Do not connect the battery to the power supply for more than 24 hours after it is already fully charged.
- It is not recommended to connect third-party devices that consume more energy than the allowed value.
- The device is equipped with a short circuit protection system, but conditions that may lead to a short circuit should be avoided.
- The recommended operating temperature for the device is -20°C to +50°C. Do not use the device beyond this temperature range, or else, it may shorten the battery life.
- When using the device at low temperatures, the battery capacity decreases. This is normal and not a defect.
- Do not use the device at the temperatures above 50°C – this may

decrease the battery's life.

- Keep the battery out of the reach of children.

8 External Power Supply

The Tube series supports external power supplies, such as the portable power source for a mobile phone (5V).

- Connect an external power supply to the USB port **(9)** of the Tube device.
- Then, the device automatically switches to the external power supply and charge the internal battery pack at the same time.
- When the external power supply is turned off, the device switches to the replaceable 18500 battery for power supply. If no replaceable 18500 battery is installed or the battery level is low, it will switch to the built-in battery pack, instead of shutdown.

9 Installation of Rifle Mount

To ensure firing accuracy, please fix the Tube at a proper position on

the weapon.

- The Tube series needs to be fixed with an adapter clamp, such as a simple Picatinny rail clamp provided in the package. The Tube series adopts a tubular body design with a diameter of 30mm, which is compatible with standard mounts with a diameter of 30mm, such as those of day scope. Proper tools can be used to install the Tube series according to the supplier's installation suggestions and steps.
- During installation, the installation position of the Tube device should be adjusted according to the distance between eye and eyepiece (eye relief) as specified in the **Specifications** and the sense of use and comfort. Failure to comply with this recommendation may result in injury to the shooter by the parts of the riflescope eyepiece when shooting.
- It is recommended to install the scope as low as possible, but keep it away from the barrel or other devices.
- It is recommended to use a torque wrench to tighten the screws of the installation clamps, so as to avoid damaging the scope body due to being over-tightened, and the recommended torque shall not

exceed 2.5nm.

- Before using the scope for hunting, please zero the device first according to the instructions as specified in the **Zeroing** section in this manual.
- It is recommended to use an eyeshade while using the scope in the dark in order to avoid detection of camouflage. Mounting the eyeshade on the eyepiece is carried out through the thread.

10 Operation

- Open the lens cover **(14)**. If the outdoor light is strong, you can close the lens cap to prevent the image from overexposure.
- Press and hold the **Power button (5)** for 2s to power on the device. Then, the home screen appears after 3s.
- Rotate the eyepiece adjusting ring **(2)** to adjust the resolution of the icon on the display.
- Rotate the lens focus ring **(13)** to focus on the object being observed.
- **Setting the image mode:** On the home screen, press the **Palette**

button (6) to switch the image mode between day mode, twilight mode and moon mode.

- **Setting the display brightness:** On the home screen, press the **Brightness button (4)** to set the display brightness level from level 1 to level 5. Meanwhile, a short prompt for the corresponding brightness icon appears at the top status of the display.
- **Setting the image sharpness and contrast:** Press the **Controller (7)** briefly to enter the shortcut menu, and set the image sharpness and contrast (refer to the section **Shortcut Menu** for details).
- **Power off:** After using the device, press and hold the **Power button (5)** for 3 seconds to enter the power-off interface with a shutdown countdown. Release the button when the countdown icon turns to 0, then a prompt

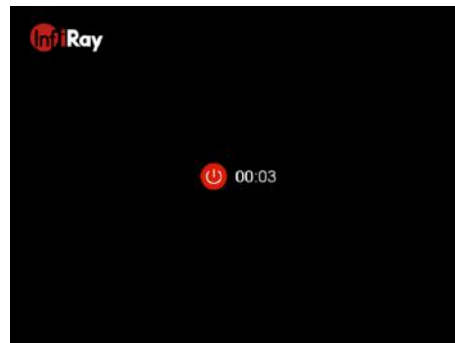



interface "Data saving ..." is displayed. When the data is saved, the display turns black and the device is off. **During the saving data, do not disconnect it from the power source, otherwise, the data cannot be saved.**

- **Standby:** On the home screen, press the **Power button (5)** briefly to standby the device. And press the **Power button (5)** again to wake up the device.
- **Active the reticle functions:** The reticle function is disabled by default, so functions related to the reticle are hidden, such as the shortcut menu, zeroing function in the main menu. So, when using the scope for the first time, press and hold the **Brightness button (4)** + **Palette button (6)** at the same time for more than 15s to turn the reticle on. The shortcut menu and the zeroing function will be enabled automatically.

11 Zeroing

The Tube series adopts the "freezing" zeroing method. It is recommended to perform zeroing in environments within the operating

temperature range of the scope.

- Fix the riflescope with the mount clamp on your weapon. For details, refer to the section **Installation**.
- Select a target at a certain distance, such as 100m, 200m, etc.
- Adjust the scope according to the operating instructions as described in the section **Operation**.
- Select a zeroing profile (refer to **Main Menu - Zeroing Profile** ).
- Point the weapon at the center of the target and shoot.
- Observe the position of the actual point of impact, and if the impact point does not match with the aiming point (the center of the riflescope reticle), keep the aiming position still, and meanwhile, press and hold the **Controller (7)** to enter the main menu interface.
- Rotate the **Controller (7)** select the **Zeroing** option . To enter the submenu of the **Zeroing** function, briefly press the **Controller (7)** (refer to **Main Menu - Zeroing**).
- Set the zeroing distance value according to the selected target distance (refer to **Main Menu - Zeroing - Zeroing Distance - Set Zeroing Distance**).
- After the zeroing distance is set up, rotate the **Controller (7)** to

select the **Zeroing** function , and press the **Controller (7)** to enter the zeroing interface (refer to **Main Menu - Zeroing - Zeroing Distance - Zeroing**). The coordinate positions of the reticle (X axis and Y axis) are displayed in the upper left corner of the display.

- Assume that the red mark  in the figure on the right is the position of the point of impact (This mark is only for illustration. It should actually be a bullet hole).



- Press and hold the **Power button (6) + Camera button (3)** to freeze the picture, and then a snow-like freezing icon  appears under the coordinate position on the upper left corner of the display.



- Move the reticle by rotating the **Controller (7)** until the reticle matches the point of impact. To switch the reticle movement

direction between X axis and Y axis, press the **Controller (7)** briefly.

- Rotate clockwise to move the reticle leftward or downward, and rotate anticlockwise to move the reticle rightward or upward.
- the position of the cursor > indicates the currently selected direction with the icon turning blue.
- After moving the reticle, a little white dot appears on the display, indicating the position of the reticle before moving.
- When the reticle matches the actual point of impact, press and hold the **Controller (7)** to save the current reticle position and return to the main menu interface.
- The center of the reticle shall coincide with the point of impact.
- Exit the menu, take another shoot – the point of impact should now match the aiming point. If not, repeat the above operations until the point of impact is consistent with that of the aiming point.

Note

- After the zeroing position is set up, you can switch the options of **Zeroing Distance** in the shortcut menu.

12 Status Bar

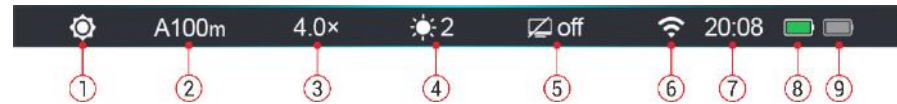





The status bar, at the top of the image interface, shows information about the device's current operations. From left to right, they are:

1. Current image mode (☀️ : day mode; 🌅 : twilight mode; 🌙 : moon mode)
2. Current zeroing profile and zeroing distance (e.g., A100m)
3. Current optical magnification (e.g., 4.0x)
4. Current display brightness (level 3 is default)
5. Standby status and time (off is default)
6. Wi-Fi (📶 : Wi-Fi is on, 🚫 : Wi-Fi is off)
7. Time (Can be set up in the main menu or synchronize the time in the InfiRay Outdoor App)
8. The power status of the replaceable battery (when 18500 battery is installed)
9. The power status of the built-in battery pack

Note: Colored battery icon indicates that the battery is supplying

power. The levels of it show the remaining battery life.

| Icon | Color / Status | Battery Status |
|---|----------------|--|
|  | Green | More than 40% |
|  | Yellow | 20% - 40% |
|  | Red | Less than 20%, need to charge instantly |
|  | Lightning icon | External power supply meanwhile charging the built-in battery pack |

13 Digital Zoom

The Tube TD50L Scope supports allows you to quickly increase the basic magnification from 4.0× to 16.0×, and the image can be correspondingly magnified from 1× to 4×.

- On the home screen, rotate the **Controller (7)** clockwise to zoom in the magnification and counterclockwise to zoom out the magnification.
- The magnifications are 4.0×, 4.5×, 5.5×, 6.0×, 7.0×, 8.0×, 9.5×, 10.5×, 12.0×, 14.0×, 16.0× in turn, which will be displayed on the top status bar in real-time.

14 Photographing and Video Recording

The Tube TD50L is equipped with a built-in 16GB memory space, which supports to take photos and record video for an observed target. The image and video files will be named after time, so it is recommended to set the system date and time in the main menu (**Main Menu - Settings - Date/Time**), or synchronize the system date and time on the **Settings** function of the InfiRay Outdoor App before photographing and video recording. Please download the APP operation manual from our official website (www.infirayoutdoor.com) for detailed operation steps.

Photographing

- On the home screen, briefly press the **Camera button (3)** to take a photo.
- When taking a photo, a camera icon  will flash below the status bar in the



upper left corner of the screen. The photo is taken successfully when the icon disappears.

- Photos are saved in the built-in memory space.
- When the exclamation mark icon  appears on the right side of the camera icon, it prompts that the memory space is insufficient. Check and transfer videos and images to other media to free up the space.

Video Recording

- On the home screen, press and hold the **Camera button (3)** to start the video recording.
- A recording icon and a prompt box showing the recording time will appear in the upper right corner of the display, with the time format as 00:00:00 (hours: minutes: seconds).
- During recording, you can also take a photo by briefly pressing the **Camera button (3)**.
- Stop the recording and save the video with a long press of the



Camera button (3).

- All videos and photos are saved in the built-in memory space.



Note

- The menu can still be operated during video recording.
- The images and the videos are stored in the built-in memory card in the format of IMG_HHMMSS_XXX.jpg (for images) and VID_HHMMSS.mp4 (for videos). HHMMSS – hours / minutes / seconds, XXX - three-digit common counter for photos which is NOT reset.
- If a file is deleted from the list, its number is not taken by the other file.
- The maximum duration of a video recording file is 10 minutes. When the duration is more than 10 minutes, the video will be automatically recorded onto a new file.
- The number of files is limited by the capacity of the built-in memory space of the device. It is suggested to check the available space of the memory card regularly and transfer your videos and images to other media to free up the space on the memory card.

- The reticle is displayed on the captured videos or images, but GUI icons are not.

Memory Access

When the device is powered on and connected to a computer, it will be recognized by the computer as a flash memory card. Then, you can access the memory of the device and copy images and videos.

- Connect the device to a computer through the data cable.
- Power on the device.
- Double click "My Computer" on the desktop of your computer - double click to open the device named "Infiray"  - double click to open the device name "Internal Storage"  to access the built-in memory.
- There are different folders named by time in the format of xxxx (year) xx (month) xx (day).
- Recorded photos and videos in that day are saved in the folders
- Select desired files or folders to copy or delete.



15 Shortcut Menu

The shortcut menu can be used for a quick setup of the basic settings of some common functions, including image sharpness, image contrast, exposure compensation and zeroing distance.





- On the home screen, press the **Controller (7)** to enter the shortcut menu interface.
- Press the **Controller (7)** briefly to switch the following function options, and the icon background of the selected option will be highlighted:
 - **Image Sharpness (▲)**: Press the **Controller (7)** to select the option, and rotate the **Controller (7)** to adjust the image sharpness from level1 to level 5.
 - **Image Contrast (●)**: Press the **Controller (7)** to select the option, and rotate the **Controller (7)** to adjust the image contrast

from level 1 to level 5.

- **Exposure Compensation** (): Press the **Controller (7)** to select the option, and rotate the **Controller (7)** to select one exposure compensation level from -3.0 to +1.0.
- **Zeroing Distance** (): Press the **Controller (7)** to select the option, and rotate the **Controller (7)** to switch between the distance values saved for the current zeroing type (e.g., For firearm type A, when you select the option, only the distance values saved for type A will be available).
- Press and hold the **Controller (7)** to save the changes and return to the home screen.
- In the shortcut menu, it will automatically save the changes and return to the home screen if there is no operation within 1min.

16 Main Menu





- On the home screen, press and hold the **Controller (7)** for 3s to enter the main menu interface.
- Rotate the **Controller (7)** to switch between the function options in the main menu, rotate clockwise to move down and anticlockwise to move up.
- The function options in the main menu are cyclical: when the cursor  reaches the last option, continue rotating the **Controller (7)** clockwise and the cursor  will move to the first option.
- Press the **Controller (7)** to modify the parameters of the current option or enter the submenu.
- The position of the cursor indicates the selected option, and the selected icon will change from white to blue.
- The operation of secondary and tertiary menus is the same as above.
- In any menu interface, press and hold the **Controller (7)** to save the changes and return to the upper menu interface. And, briefly press the **Power button (5)** to return to the upper menu without saving.
- In the main menu interface, the device will automatically return to the home screen without any saving if there is no operation within 1min.
- During the continuous operation of the scope, when exiting from the





main menu, the cursor > remains at the position before exiting.







time, the selected option stays at the first menu option.



When you restart the scope and enter the main menu for the first



Main Menu Features and Descriptions

| | | |
|---|---|--|
| <p style="text-align: center;">Wi-Fi</p>  | <p>Turn the Wi-Fi function on/off</p> <ul style="list-style-type: none"> ● Press and hold the Controller (7) to enter the main menu. ● Rotate the Controller (7) to select the Wi-Fi function option. ● Press the Controller (7) to turn Wi-Fi function on/off. ● When Wi-Fi is on, the default password is prompted for 3s behind Wi-Fi function. ● The password is only displayed for the first three times. When the password is changed, it will not be displayed. ● The icon in the status bar changes accordingly when Wi-Fi is turned on or off. |  |
| <p style="text-align: center;">Target Height Setting</p>  | <p>Set the target height of the stadiametric rangefinder</p> <ul style="list-style-type: none"> ● Press and hold the Controller (7) to enter the main menu. ● Rotate the Controller (7) to select the Target Height Setting option. ● Press the Controller (7) to enter the submenu of Target Height Setting. ● Rotate the Controller (7) to select one type of animals. ● Press the Controller (7) to activate the height reset function accompanied by two triangle icons appearing above and below the value. ● Rotate the Controller (7) to change height value of the animal. The height will be increased or decreased by 0.1m with each |  |





| | |
|--|---|
| | <p>rotation.</p> <ul style="list-style-type: none"> ● Press the Controller (7) to save the height and return to the previous menu. |
| <p>Reticle Color</p>  | <p>Select the color of the reticle</p> <ul style="list-style-type: none"> ● Press and hold the Controller (7) to enter the main menu. ● Rotate the Controller (7) to select the Reticle Color function option. ● Press the Controller (7) briefly to enter the submenu of the Reticle Color function. ● There are four colors for selection – Black, White, Red and Green. ● Rotate the Controller (7) to select the color you want and short press the Controller (7) to confirm your selection and return to the main menu interface. ● The color of the reticle will change when you switch the color selection.  |
| <p>Reticle Type</p>  | <p>Select the type of the reticle</p> <ul style="list-style-type: none"> ● Press and hold the Controller (7) to enter the main menu. ● Rotate the Controller (7) to select the Reticle Type function option. ● Press the Controller (7) briefly to enter the submenu of the Reticle Type function. ● There are seven types for selection. ● Rotate the Controller (7) to select the type you want and short press the Controller (7) to confirm your selection and return to the main menu interface. ● The reticle type will change when you switch the type selection.  |





| | | |
|---|---|--|
| <p>Zeroing Profile</p>  | <p>Select Zeroing Profile</p> <ul style="list-style-type: none"> ● Press and hold the Controller (7) to enter the main menu. ● Rotate the Controller (7) to select the Zeroing Profile option. ● Press the Controller (7) to enter the submenu of the zeroing profile. ● Rotate the Controller (7) to select one from the three zeroing profiles (A, B, C). ● Press the Controller (7) to confirm the selection, and return to the main menu. ● The name of the selected profile will change in the status bar. |  |
| <p>Zeroing</p>  | <p>Please set up the zeroing profile and zeroing distance before carrying out any zeroing operation.</p> <p>The Tube series supports any zeroing distance between 1 and 999 meters.</p> <ul style="list-style-type: none"> ● Press and hold the Controller (7) to enter the main menu. ● Rotate the Controller (7) to select the Zeroing option. ● Press the Controller (7) to enter the submenu for Zeroing distance selection which is displayed as --m by factory default indicating that no distance has been set. ● The TD50L supports up to 3 types of zeroing distance for each zeroing profile. ● Rotate the Controller (7) to select one zeroing distance and press the Controller (7) briefly to confirm selection and enter the zeroing distance submenu as follows. |  |
| <p>Zeroing</p>  | <p>If the zeroing distance is consistent with the preset target distance, you can zero your device directly as follows.</p> <ul style="list-style-type: none"> ● Select the Zeroing  option and briefly press the Controller (7) to enter the Zeroing interface. | |



| | | |
|---|--|--|
| | <ul style="list-style-type: none"> ● The X axis and Y axis coordinates of the reticle are displayed at the top left corner of the screen. ● Keep the aiming position still, press and hold the Palette (6) + Camera (3) buttons at the same time to freeze the picture, and the freezing icon ❄ appears on the bottom center of the screen. ● Move the reticle position by rotating or pressing the Controller (7) until the reticle center matches with the point of impact. For details, refer to the section Zeroing. |  |
| <p>Zeroing Distance Setting</p> <p>▼ 000 ▲</p> | <p>Add a new zeroing distance</p> <ul style="list-style-type: none"> ● Select a non-primary distance and enter the submenu for operation with a brief press of the Controller (7). ● Rotate the Controller (7) to select the Zeroing Distance Setting option. ● Press the Controller (7) briefly to activate the zeroing distance reset function, and then two small triangle symbols are displayed above and below the number 0. ● Rotate the Controller (7) to set the number value of the current position from 0 to 9. ● Press the Controller (7) to switch among the positions of hundred, ten and one digits. ● After setting, press and hold the Controller (7) to save settings and exit. The cursor returns to the zeroing option, and the zeroing distance changes accordingly. |  |



| | |
|--|---|
| | <ul style="list-style-type: none"> Besides, the status bar updates to the new zeroing distance synchronously. |
| <p>Standby</p>  | <p>Set the automatic standby status and time</p> <ul style="list-style-type: none"> Press and hold the Controller (7) to enter the main menu. Rotate the Controller (7) to select the Standby option. Press the Controller (7) briefly to enter the Standby submenu. Rotate the Controller (7) to select one option from 10min, 20min, 30min and off. Press the Controller (7) to confirm the selection, and then the selected option is displayed on the top status bar. If off is selected, the standby function is disabled. <p>Note:</p> <ul style="list-style-type: none"> When the device is in the following status, the standby mode is activated automatically: up > 70° or down > 70°, and left >30° or right > 30° When the device is in the shooting status (horizontally positioned), the standby mode is disabled. |
| <p>Settings</p>  | <p>This function is used to set the date, time, language, measurement unit, status auto hiding, factory reset, firmware update and device information query.</p> <ul style="list-style-type: none"> Press and hold the Controller (7) to enter the main menu. Rotate the Controller (7) to select the Settings option. Press the Controller (7) to enter the submenu of the settings. This menu item allows you to configure the following settings. |

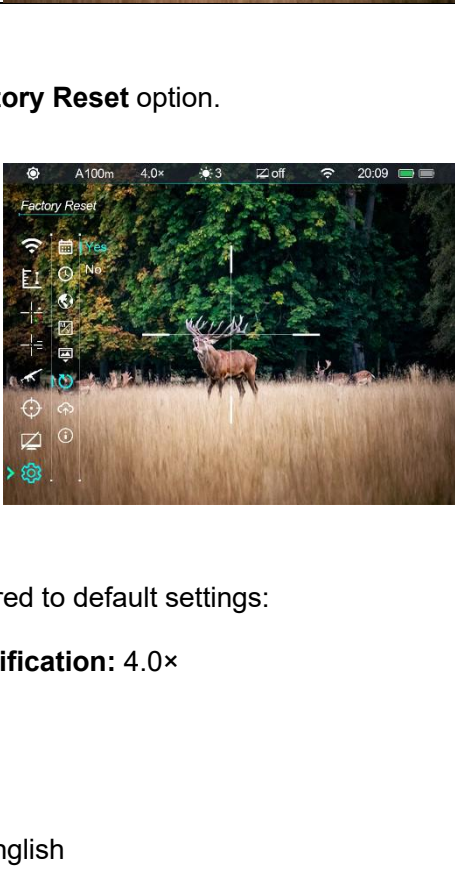

| | |
|--|--|
| <p style="text-align: center;">Date</p>  | <p>Setting the system date</p> <ul style="list-style-type: none"> ● In the Settings submenu, rotate the Controller (7) to select the Date option. ● Press the Controller (7) briefly to activate the date reset function accompanied by two triangle icons appearing above and below the value. ● Date format is displayed as YY.MM.DD format. ● Rotate the Controller (7) to set the correct year, month and date. ● Press the Controller (7) to switch among year, month and date. ● After setting, press and hold the Controller (7) to save changes and exit the date setting function.  |
| <p style="text-align: center;">Time</p>  | <p>Setting the system time</p> <ul style="list-style-type: none"> ● In the Settings submenu, rotate the Controller (7) to select the Date option. ● Time format is displayed as HH:MM in 24-hours format (14:48). ● Press the Controller (7) briefly to activate the date reset function accompanied by two triangle icons appearing above and below the value. ● Rotate the Controller (7) to set the correct hour and minute. ● Press the Controller (7) to switch between the hour and minute. ● After setting, press and hold the Controller (7) to save changes and exit the time reset function. ● After setting time, the time in the status bar changes accordingly.  |

| | | |
|--|---|--|
| <p style="text-align: center;">Language</p>  | <p>Selecting language</p> <ul style="list-style-type: none"> ● In the Settings submenu, rotate the Controller (7) to select the Language option. ● Press the Controller (7) to enter the submenu for language selection. ● Rotate the Controller (7) to switch among English and Russian. ● Press the Controller (7) to confirm the selection and return to the upper menu. |  |
| <p style="text-align: center;">Units of Measure</p>  | <p>Selecting the units of measure</p> <ul style="list-style-type: none"> ● In the Settings submenu, rotate the Controller (7) to select the Units of Measure option. ● Press the Controller (7) to enter the submenu for unit setup. ● Rotate the Controller (7) to switch between meter and yard. ● Press the Controller (7) to confirm the selection and exit to the upper menu interface. |  |
| <p style="text-align: center;">Status Auto Hiding</p>  | <p>Enabling/Disabling status auto hiding</p> <ul style="list-style-type: none"> ● In the Settings submenu, rotate the Controller (7) to select the Status Auto Hiding option. ● Press the Controller (7) to enter the submenu of the status auto hiding option. | |

| | | |
|--|--|--|
| | <ul style="list-style-type: none"> ● Rotate the Controller (7) to select On or Off. ● Press the Controller (7) to confirm the selection and return to the upper menu interface. |  |
| <p>Factory Reset</p>  | <p>Reset to factory settings</p> <ul style="list-style-type: none"> ● In the Settings submenu, rotate the Controller (7) to select the Factory Reset option. ● Press the Controller (7) to enter the submenu. ● Rotate the Controller (7) to select "Yes" for restoring factory settings or "No" for canceling the operation. ● Press the Controller (7) to confirm the selection. ● If "Yes" is selected, the scope will reboot automatically. ● If "No" is selected, the operation is canceled and return to the upper menu. <p>After the Factory Reset is selected, the following functions will be restored to default settings:</p> <ul style="list-style-type: none"> - Image Mode: Day mode - Image Sharpness: Level 1 - Image Contrast: Level 1 - Display Brightness: Level 3 - Optical Magnification: 4.0× - Standby: Off - Wi-Fi: Off - Language: English |  |

| | |
|---|--|
| | <ul style="list-style-type: none"> - Exposure Compensation: 0.0 - Unit of Measure: Meter - Zeroing Distance: A--m - Status Auto Hiding: Off |
| <p style="text-align: center;">Firmware Update</p>  | <p>Update the firmware</p> <ul style="list-style-type: none"> ● Before the update, it needs to save the newest upgrade firmware files to the memory space of device via the USB cable. ● In the Settings submenu, rotate the Controller (7) to select the Firmware Update option. ● Press the Controller (7) to enter firmware update function. ● The device will check the new firmware in the memory of device, and if there are right firmware files, the devices will update automatically. ● The newest upgrade firmware files can be downloaded on the official website (www.infirayoutdoor.com). ● It can also be upgraded remotely through the InfiRay Outdoor APP (see the section Update and InfiRay Outdoor). |
| <p style="text-align: center;">Info</p>  | <p>Show device information</p> <ul style="list-style-type: none"> ● In the Settings submenu, rotate the Controller (7) to select the Info option. ● The relevant information of riflescope will be shown by a short press of the Controller (7). ● This item allows the user to view the following information about the riflescope: the product model, GUI version, SYS Info, Boot |



version, FPGA, PN and SN number of the riflescope, Hardware version and FCC ID.

- Press and hold the Controller (7) to return to the upper menu interface.

17 PIP Function

Picture-in-Picture (PIP) provides a floating window independent of the main image. This window shows the image which is enlarged to 2× in a certain area centered on the reticle of the main image.

- On the home screen, press and hold the **Palette button (6)** to switch the PIP function on/off.
- When the PIP is on, a separate 'window' is appeared on the top of the display simultaneously with the main image.
- When the main image is enlarged by rotating the **Controller (7)**, the image shown in the PIP window is also enlarged accordingly.
- For example, when the magnification of the main image is 4×, the



corresponding magnification of the PIP image is 8×.

Note

- Due to some factors, this function is not available for some regions.

18 Stadiametric Rangefinder

The Tube series provides stadiametric rangefinder, which allows you to calculate the approximate distance from a target with a known size.

- On the home screen, press and hold the **Brightness button (4)** to turn the stadiametric rangefinder function on.
- When the function is on, two T-lines used for measuring appear in the middle part of the image, and four icons of pre-configured objects and the values of measurement distance are displayed on the left side.
- The height of the four pre-defined target are as follows:

- Hare: 0.2m high
- Wild boar: 0.9m high
- Deer: 1.7m high
- Custom: 1.0m height
- The height can be reset in the main menu (see **Main Menu - Target Height Setting**).



- Adjust the device to locate the target in the center of the display area.
- Rotate the **Controller (7)** clockwise to enlarge or anticlockwise to reduce the width of the measurement lines, so that the target is completely between the measurement lines. While adjusting the width of the measurement lines, the rangefinder values on the right will change accordingly.
- The color and center position of the measurement line are synchronized with the reticle.
- The default measurement unit is meter, and it can be set to be yard in the main menu (see **Main Menu-Settings-Units of Measure**).

- Press and hold the **Brightness button (4)** to exit the stadiametric rangefinder function.

19 Status Auto Hiding

This function is used to automatically hide the GUI information on the interface other than the reticle, so to make the image unobtrusive.

- Rotate the **Controller (7)** to select **Settings** option in the main menu.
- Press the **Controller (7)** to enter the Settings submenu, and rotate the **Controller (7)** to select **Status Auto Hiding** option.
- Press the **Controller (7)** to enter the submenu of Status Auto Hiding option and then select On or Off by rotating the **Controller (7)**.
- After the status auto hiding is enabled, all GUI icons including the status bar will be automatically hidden and only the image and reticle are displayed if there is no operation within 8s.
- The GUI information will be displayed again with the press of any button.
- Only after the GUI is displayed, the button and menu can be manipulated.

20 Wi-Fi

The Tube series has a built-in Wi-Fi module. The device can connect wirelessly to a mobile device (laptop or smartphone) via Wi-Fi.

- To enable the wireless module, enter the main menu by long pressing the **Controller (7)**.
- Rotate the **Controller (7)** to select the **Wi-Fi** option.
- Press the **Controller (7)** briefly to turn on/off Wi-Fi module.
- After the Wi-Fi of the scope is on, search for the Wi-Fi signal with the name InfiRay_XXXXXX on the mobile device, of which, XXXXXX is a 6-bit serial number composed of digits and letters.
- Select the Wi-Fi, enter the password and connect. The initial password is 12345678.
- When Wi-Fi is successfully connected, you can control the scope via the mobile app.

Setting Wi-Fi name and password

The Wi-Fi name and password of Tube series can be reset in the **InfiRay Outdoor** application.

- After connected with the mobile device, find and click the "Setting" icon  in the **InfiRay Outdoor** to enter the setting interface.
- In the text box, enter and submit the new name (SSID) and password of the Wi-Fi.
- It needs to reboot the device to take the new name and password effect.

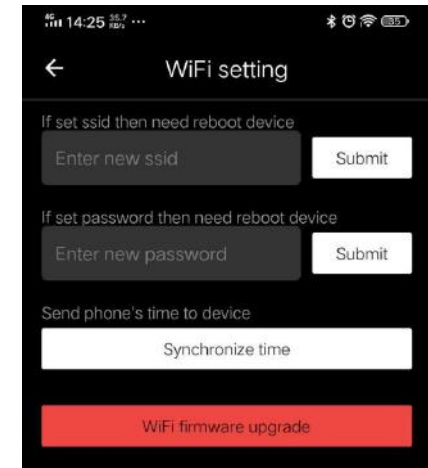

Note

- After the device is restored to the factory settings, the name and password of the Wi-Fi will also be restored to the default factory default settings.

21 Update and InfiRay Outdoor

The Tube series thermal imaging riflescopes supports **InfiRay Outdoor**

technology, which allows you to transmit the image from the thermal imager to the smartphone or tablet via Wi-Fi in real time mode.

You can find detailed instructions on **InfiRay Outdoor** at the official website www.infirayoutdoor.com.

The design of the riflescope provides the software update option. Updating is possible via the **InfiRay Outdoor** application. Also, it is feasible to download and update software from the official website.

About InfiRay Outdoor

- Download the **InfiRay Outdoor** App in the official website or app store, or by scanning the QR code.
- Turn on the Wi-Fi function of the scope in the main menu.
- Open **InfiRay Outdoor** application on the mobile device.
- Search and connect the Wi-Fi signal with the name InfiRay_XXXXXX on the mobile device.
- After successful connection, an update prompt will be displayed



automatically. Click **Now** to download the latest version immediately or click **Later** to update later.

- **InfiRay Outdoor** will automatically store the last connected device. So, if the scope has not connected with your mobile device, but linked to **InfiRay Outdoor** before, the update prompt will appear if there is an update when opening **InfiRay Outdoor**. You can download the update first via mobile Wi-Fi and then connect the scope with mobile device to finish the update.
- After finishing the update, the device will root.

22 Technical Inspection

It is recommended to carry out a technical inspection each time before using the riflescope. Check the following:

- The scope appearance (there should be no cracks on the body).
- The condition of the object lens and eyepiece (there should be no cracks, greasy spots, dirt or other deposits).
- The status of the rechargeable battery (it should be fully charged in advance) and electrical contact (no salinization or oxidation).

- The electrical controls/buttons should be in working order.

23 Maintenance

The maintenance should be carried out at least twice a year and includes the following steps:

- Wipe the external surface of metal and plastic parts off dust with a cotton cloth. Silicone grease may be used for cleaning process.
- Clean the electric contacts and battery slots on the riflescope using a non-greasy organic solvent.
- Check the optics of the lens and the eyepiece. If necessary, remove

the dirt and sand from the optics (it is perfect to use a non-contact method). Cleaning of the exterior of the optics should be done with cleaners designed especially for this purpose.

24 Troubleshooting

The following table lists all the problems that may occur when operating the scope. Carry out the recommended checks and troubleshooting steps in the order shown in the table. If there are defects that are not listed in the table or it is impossible to repair the defect yourself, return the scope to the vendor or supplier for repair service.

| Faults | Possible Causes | Solutions |
|--|--|--|
| The scope cannot be started | The battery is out of charge | Charge the battery |
| The device cannot be powered by an external power supply | The USB cable is damaged | Replace the USB cable |
| | The external power supply is insufficient | If necessary, check the external power supply |
| The Image is too dark. | The display brightness level is too low. | Adjust the display brightness |
| The GUI icons are clear but images are blurry | The lens is not focused | Rotate the lens focus ring to adjust the focus |
| | There is dust or condensate on the interior or | Wipe off the outer optical surface by using a soft cotton cloth. |

| | | |
|---|--|--|
| | exterior optical surfaces of the lens. | Let the riflescope dry by leaving it in a warm environment for 4 hours. |
| The position of the reticle moves after shooting | The scope or the mount clamp is not fixed firmly. | <p>Check that the scope has been securely mounted.</p> <p>Make sure that the bullet type and caliber you use are as consistent with that used for zeroing.</p> <p>If your scope was zeroed in summer but used in winter (vice versa), the zeroing point may move slightly.</p> |
| The scope cannot focus | Configuration error | <p>Set the scope according to the section Operation.</p> <p>Check the outer surface of the objective lens and eyepiece, and if necessary, wipe off any dust and frost on it.</p> <p>In cold weather, a special antifogging coating can be applied (such as those used on eyeglasses or car rearview mirrors).</p> |
| The device cannot connect with the smartphone or tablet PC. | The Wi-Fi password is incorrect | Input the correct password |
| | There are too many Wi-Fi signals around the device, which may cause interference. | Move the device to an area with no or fewer Wi-Fi signals. |
| Wi-Fi signals are lost or interrupted | Smartphone or tablet is out of range of a strong Wi-Fi signal. Or there are obstacles between device and the smartphone or tablet (such as concrete wall). | Move the device to a place where you can receive Wi-Fi signals. |

| | | |
|--|--|--|
| The observed target disappears | Observe the target through the glass. | Remove the glass from the field of vision. |
| The image quality is poor or the detection range is reduced. | These problems may occur due to the weather condition, such as snow, rain, fog etc. | |
| When the device is used at a low temperature, the imaging quality is poorer than that at normal temperature. | <p>At temperatures above 0°C, the temperature rise varies with the observed objects (environment and background) due to different heat conductivity coefficients. As a result, high-temperature contrast occurs and the image quality is better.</p> <p>At low temperatures, the observed targets (background) usually cool down to a similar temperature because of reduced temperature contrast. Therefore, the image quality (details in particular) is poor, which is a characteristic of thermal imaging devices.</p> | |

25 Legal and Regulatory Information

Wireless transmitter module frequency range:

WLAN: 2.412-2.472GHz (For EU)

Wireless transmitter module power < 20dBm (only for EU)

IRay Technology Co., Ltd. thus declares that the Tube series thermal imaging rifle scope complies with the directives 2014/53/EU and



2011/65/EU. The full text of the EU declaration of conformity as well as additional information are available at: www.infirayoutdoor.com.

This device may be operated in all member states of the EU.

FCC Statement

FCC-ID: 2AYGT-TD50L

Labeling requirements

This device complies with part 15 of the FCC Rules. Operation is subject to the following two conditions: (1) This device may not cause harmful interference, and (2) this device must accept any interference received, including interference that may cause undesired operation.

Information to the user

Any Changes or modifications not expressly approved by the party responsible for compliance could void the user's authority to operate the equipment.

Note: The manufacturer is not responsible for any radio or TV interference caused by unauthorized modifications to this equipment. Such modifications could void the user's authority to operate the equipment.

Note: This equipment has been tested and found to comply with the limits for a Class B digital device, pursuant to part 15 of the FCC Rules. These limits are designed to provide reasonable protection against harmful interference in a residential installation. This equipment generates uses and can radiate radio frequency energy and, if not installed and used in accordance with the instructions, may cause harmful interference to radio communications. However, there is no

guarantee that interference will not occur in a particular installation. If this equipment does cause harmful interference to radio or television reception, which can be determined by turning the equipment off and on, the user is encouraged to try to correct the interference by one or more of the following measures:

- Reorient or relocate the receiving antenna.
- Increase the separation between the equipment and receiver.
- Connect the equipment into an outlet on a circuit different from that to which the receiver is connected.
- Consult the dealer or an experienced radio/TV technician for help.

This equipment complies with FCC RF radiation exposure limits set forth for an uncontrolled environment.

Body-worn Operation

This device was tested for typical body-support operations. To comply with RF exposure requirements, a minimum separation distance of 0.5cm must be maintained between the user's body and the handset, including the antenna. Third-party belt-clips, holsters, and similar accessories used by this device should not contain any metallic components. Body accessories that do not meet these requirements

may not comply with RF exposure requirements and should be avoided.

Use only the supplied or an approved antenna.

We, IRay Technology Co., Ltd., hereby declare that this product was tested conforming to the applicable FCC rules under the most accurate measurement standards possible, and that all the necessary steps have been taken and are in force to assure that production units of the same equipment will continue to comply with the Commissions requirements.