

ACE

Thermal Imaging Scope



User Manual

ACE L35 / ACE H50 / ACE H50R / ACE S60R

V1.0

IMPORTANT SAFETY INFORMATION

Environmental influences

- Never point the lens of the device directly at intense heat sources such as the sun or laser equipment. The objective lens and eyepiece can function as a burning glass and damage the interior components.
- Avoid touching the metal surface (cooling fins) after exposure to sunlight or cold.

Ergonomics notes

Take breaks after longer periods of use to avoid wrist pain.

Risk of swallowing

Do not place this device in the hands of small children. Incorrect handling can cause small parts to come loose which may be swallowed.

Safety instructions for use

- Handle the device with care: rough handling can damage the internal battery.
- Do not expose the device to fire or high temperatures.
- Install the batteries correctly according to the instruction on the device. Reverse connection is prohibited.
- The battery capacity decreases when operated in a cold ambient temperature. This is not a fault and occurs for technical reasons.
- The recommended temperature for using this product is -20° to +50°. Otherwise, it will affect the service life of the product.
- Do not store the device for long periods at temperatures below -20°C or above 50°C, or it will permanently reduce the battery capacity.
- Always store the device in a dry, well-ventilated space.
- If the device has been damaged or the battery is defective, send the device to our after-sales service for repair.

Safety instructions for the power supply unit

- Check the power supply unit, cable and adapter for visible damage before use.

- Do not use any defective parts. Defective components must be replaced.
- Do not use the power supply unit in wet or humid environments.
- Only charge the device at temperatures ranging between 0°C and 50°C.
- Do not make any technical modifications.

Disposal of batteries



Directive 2006/66/EC (battery directive): This product contains a battery that cannot be disposed of as unsorted municipal waste in the European Union. For battery details, refer to the documentation of the specific product. The battery is marked with this symbol, which may include Cd (indicating cadmium), Pb (indicating lead), or Hg (indicating mercury). For proper recycling, please return the battery to your supplier or send it to a designated collection point. For more information, visit www.recyclethis.info.

User information on the disposal of electrical and electronic devices (private households)



2012/19/EU (WEEE directive): Products marked with this symbol cannot be disposed of as unsorted municipal waste in the European Union. For proper recycling, return this product to your local supplier upon the purchase of equivalent new equipment, or dispose of it at designated collection points. For more information see: www.recyclethis.info.

For business customers within the European Union

Please contact your dealer or supplier regarding the disposal of electrical and electronic devices. He will provide you with further information.

Information on disposal in other countries outside of the European Union

This symbol is only applicable in the European Union. Please contact your local authority or dealer if you wish to dispose of this product and ask for a disposal option.

Intended use

The device is intended for displaying heat signatures during nature

observation, remote hunting observations and for civil use. This device is not a toy for children.

Use the device only as described in this operating manual. The manufacturer and the dealer accept no liability for damages which arise due to non-intended or incorrect use.

Function test

- Before use, please ensure that your device has no visible damage.
- Test to see if the device displays a clear, undisturbed image.

- Check that the settings for the thermal imaging monocular are correct. See the notes in the section **Power On and Image Settings**.

Installing/Removing the battery

The ACE Thermal Imaging Scope is equipped with two power supply systems - one built-in battery pack and one replaceable 18650 battery.

The built-in battery pack cannot be removed.

1 Specifications

Model	ACE L35	ACE H50	ACE H50R	ACE S60R
Detector Specifications				
Type	Vox	Vox	Vox	Vox
Resolution, Pixels	384×288	640×512	640×512	1280×1024
Pixel Size, um	12μm	12μm	12μm	12μm
NETD, mK	≤ 18	≤ 15	≤ 15	≤ 15
Frame Rate, Hz	60	60	60	50
Optical Specifications				
Objective Lens, mm	35/F0.9	50/F0.9	50/F0.9	60/F1.0
Field of View (H×V), °	7.5×5.7	8.8×7.0	8.8×7.0	14.7×11.7
Linear Field of View (H×V), m @ 100m	13.2×9.9	15.4×12.3	15.4×12.3	25.6×20.5
Magnification, x	4~16	3~24	3~24	2~24
Ocular zoom, x	1~3	1~3	1~3	1~3
Eye Relief, mm	50	50	50	50
Exit Pupil Diameter, mm	8	8	8	8
Diopter, D	-5~+5	-5~5	-5~+5	-5~+5
Detection Range, m(Target Size: 1.7m×0.5m, P(n)=99%)	1800	2600	2600	3100
Display Specifications				
Type	AMOLED	AMOLED	AMOLED	AMOLED

Resolution	2560×2560	2560×2560	2560×2560	2560×2560
Battery Power Supply				
Battery	Built-in battery/4000mAh + Replaceable 18650 battery			
Max. Operating Time (22°C), h*	7	7	7	6
External Power Supply	5V (Type C)	5V (Type C)	5V (Type C)	5V (Type C)
Physical Specifications				
Wi-Fi / APP	Support	Support	Support	Support
Photo / Video Recorder	Support	Support	Support	Support
Recoil Activated Video	Support	Support	Support	Support
Gallery	Support	Support	Support	Support
Memory Capacity	64GB	64GB	64GB	64GB
IP Rating	IP67	IP67	IP67	IP67
Operating Temperature, °C	-20 ~ +50	-20 ~ +50	-20 ~ +50	-20 ~ +50
Weight, g	1050	1090	1120	1300
Dimension, mm	350x90x62	365x90x68	365x90x68	390x90x71
Connections and Compatibilities				
Max. Recoil Power on Rifled Weapon (Eo), Joules	6000	6000	6000	6000
Compatible Mount	30mm Tube	30mm Tube	30mm Tube	30mm Tube
Connections and Compatibilities				
Safety Class for Laser Rangefinder	NA	NA	Class 1	Class 1
Measuring Range, m	NA	NA	1200, ±1	1200, ±1
Ballistic Calculation	NA	NA	Support	Support

- ★ The actual battery life depends on the use frequency of functions like Wi-Fi, video recording, etc.
- Improvements may be made to the design and software of this product to enhance its features without prior notice.
- The newest user manual can be downloaded at our official website: www.nocpix.com.

2 Package Contents

- ACE Series Thermal Imaging Scope
- Heated target for zeroing
- Lens cloth
- 2*18650 battery
- Type-C cable
- Quick start guide
- Battery charger
- Portable bag

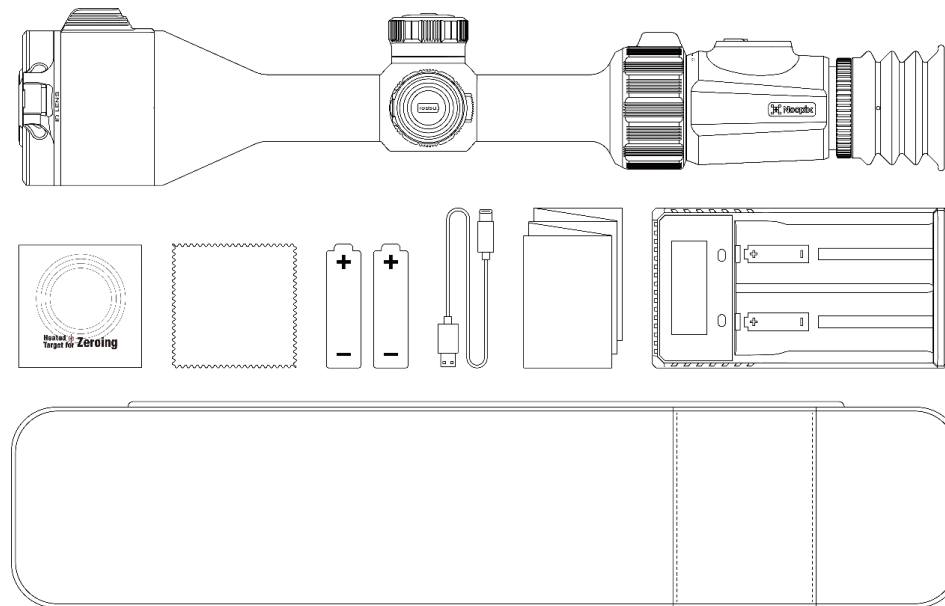

3 Description

ACE series is an infrared scope for outdoor hunting. Designed based on infrared thermal imaging principles, it requires no external light sources during the day and at night, in all hard weather conditions (such as rain, snow, fog, and haze). It can be used without being affected by strong light and to observe even targets behind obstacles (such as branches, grass, and shrubs). ACE series has a variety of battery-powered solutions with long operating hours, and can be widely used for hunting, observation and positioning in low visibility conditions.

4 Features



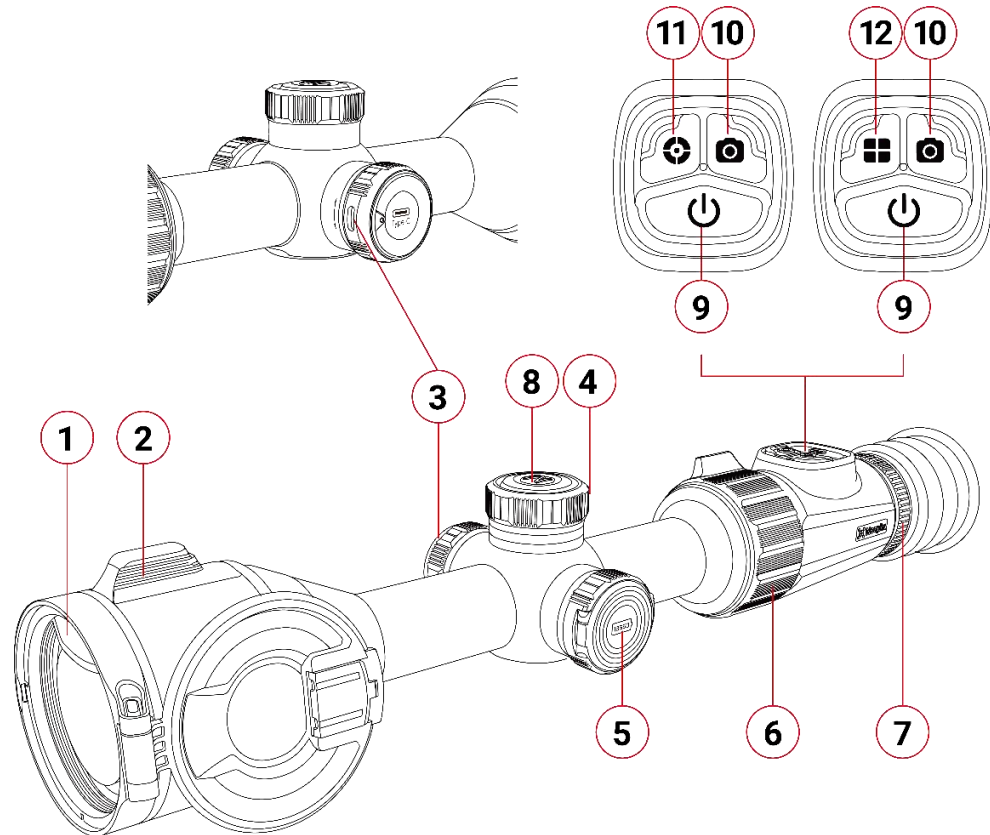

- 15mK NETD
- Ocular zoom
- Built-in LRF (ACE H50R / ACE S60R)
- Ballistic Calculation (ACE H50R / ACE S60R)
- Recoil Activated Video function
- Gallery function
- Dual power supply system
- Built-in memory, supporting photographing, video recording
- Built-in Wi-Fi module, supporting APP connection
- Built-in compass and motion sensor
- PIP (picture-in-picture) function
- Shut less function
- Pixel defect correction
- Convenient operation interface

5 Components and Controls

- 1. LRF
- 2. Lens focus Ring
- 3. Type C
- 4. Controller
- 5. Battery cap
- 6. Ocular zoom ring
- 7. Eyepiece diopter adjustment ring
- 8. Menu button
- 9. Power button
- 10. Photo button
- 11. Rangefinder button
- 12. Image mode button



6 Button Operation

Button	Current Status	Short Press	Long Press
Power Button 	Powered off	--	Power on the device
	Home screen	Image calibration	On the Home screen, a 3-2-1 countdown prompt appears. <ul style="list-style-type: none"> ➤ If the Power button is released during the countdown, the device enters into Standby mode. ➤ When the countdown completes, the device will power off.
	Continuous ranging	Exit continuous ranging	
	Shortcut/Main menu interface	Return to home screen / Return to the previous interface without saving	
Rangefinder Button (ACE H50R / ACE S60R) 	Home screen	Perform a single ranging	Open / Exit continuous ranging
Image Mode Button (ACE L35 / ACE H50) 	Home screen	Switch the image mode	---
Photo Button 	Home screen	Take a photo	Start video recording
	Video recording	Take a photo	Stop and save the video recording
Menu Button 	Home screen	Enter the Shortcut Menu interface	Enter the Main Menu interface
	Shortcut Menu interface	Adjust parameters	Save and back to the Home screen

	Main Menu interface	Adjust parameters / Enter the submenu
	Zero/ Pixel defect calibration interface	Switch the movement direction
Controller	Home screen	PIP is ON: rotate, electronic zoom PIP image PIP is OFF: rotate, electronic zoom image
	Shortcut menu interface	Rotate, switch the Shortcut menu options
	Main menu interface	Rotate, switch the Main menu options
	Zero/ Pixel defect calibration interface	Rotate, move the reticle position

7 Power Supply

ACE series uses a dual power supply system: a built-in rechargeable lithium-ion battery pack and a replaceable 18650 battery, with dual battery power for up to 7 hours of normal operating time. The battery should be fully charged before the first use.

Charging the Built-in Battery

- Charge the built-in battery via the Type C interface.

- Rotate the cover to open or hide the type C interface

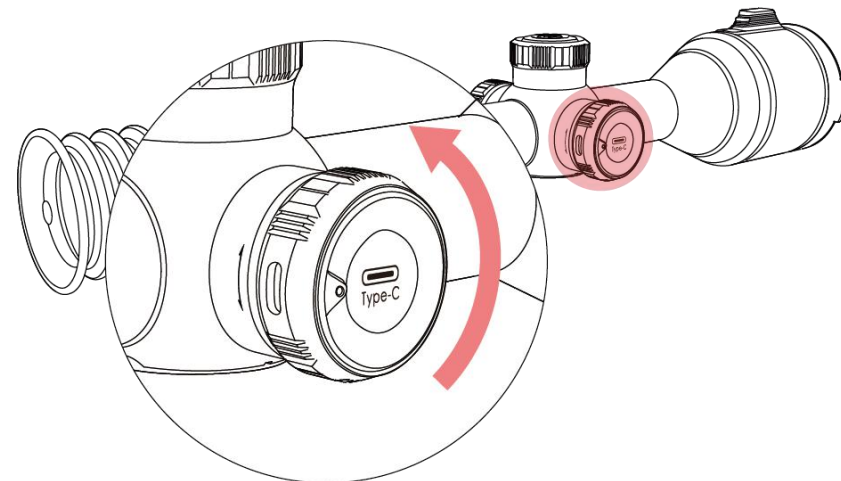

Installing the replaceable 18650 battery

Please install the 18650 battery correctly according to the following polarity markings.

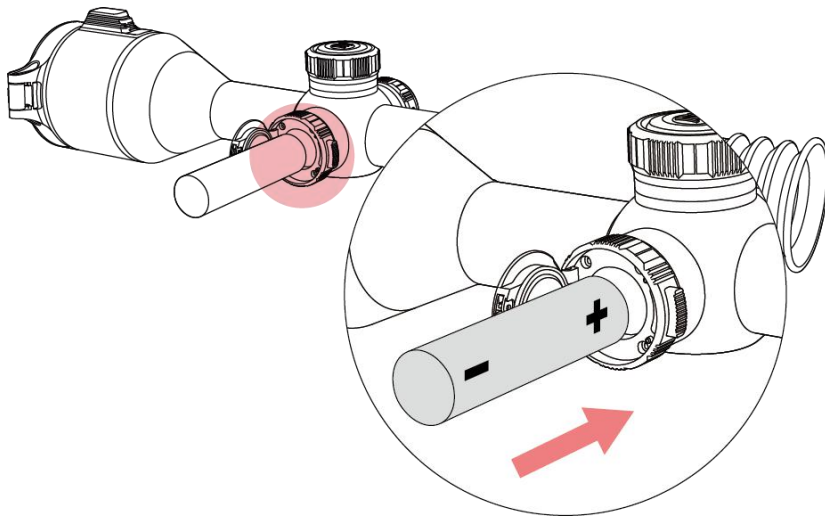

Note: The replaceable 18650 battery should be charged using a separate battery charger and cannot be charged via the ACE's Type C interface.

Switching between two types of batteries

- The left power icon displays the power level of the replaceable 18650 battery.
- The right power icon displays the power level of the built-in battery.
- When both the replaceable 18650 battery and the built-in battery are present, the replaceable 18650 battery will be used firstly. Safety Precautions

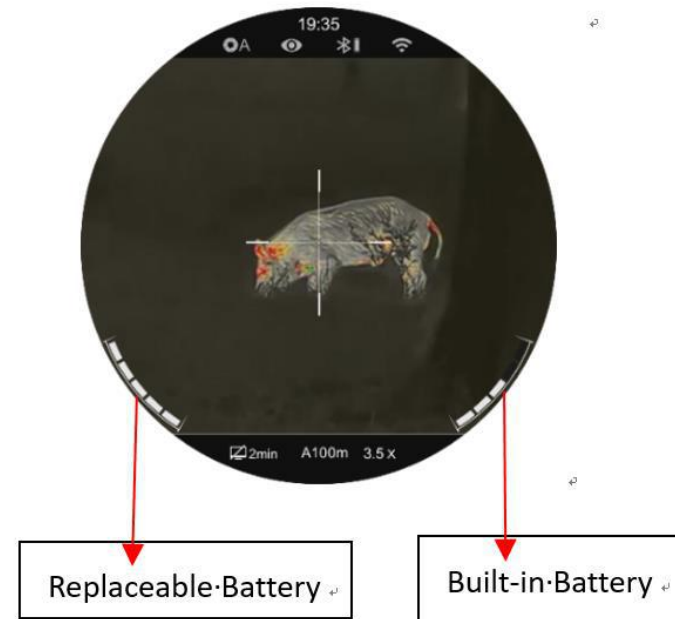

Safety precautions

- When charging, please use the 5V2A power adapter compatible with the device. Using any other type of adapter may cause irreversible damage to the battery or the adapter itself.
- If the device is not used for a long time, the battery should be partially charged, not fully charged or discharged.
- Do not charge the device immediately after it is moved to a warm environment from a cold environment. Wait for 30 to 40 minutes for preheating.
- Do not use the charger if it is modified or damaged.
- The device should be charged at a temperature of 0°C to +40°C. Otherwise, the battery life will be significantly reduced.
- When charging, please do not leave the battery unattended.
- Do not connect the battery to the power supply for more than 24 hours after it is already fully charged.
- It is not recommended to connect third-party devices that consume more energy than the allowed value.
- The device is equipped with a short circuit protection system, but conditions that may lead to a short circuit should be avoided.

- Use the device at the recommended operating temperature from -20°C to +50°C. Do not use the device beyond this temperature range, or otherwise, the use may shorten the battery life.
- When the device is used under sub-zero temperature, the battery capacity drops. This is normal and does not indicate a defect.

8 Usage

Powering on and off

- Press and hold the **Power button** for 2s to start the device. Wait for 3s to complete the startup.
- Adjust the clarity of icons on the display by rotating the **eyepiece diopter adjustment ring**.
- Rotate the **Lens focus ring** to focus on the object to be observed.
- On the Home screen, short press the **Menu button** to enter the shortcut menu.
- Long press the **Menu button** to enter main menu.

- On the Home screen, press the **Power button** for image calibration. When performing background calibration, please cover the lens cap.
- Please set the calibration mode in main menu.
- On the Home screen, press and hold the **Power button** to initiate a 3-2-1 countdown prompt. When the countdown completes, the device will power off.
- If the **Power button** is released during the countdown, the device will enter Standby mode, indicated by a standby icon.
- On the standby screen, either short press or long press the **Power button** will wake up the device.

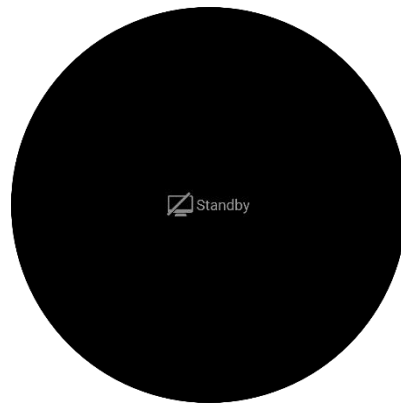
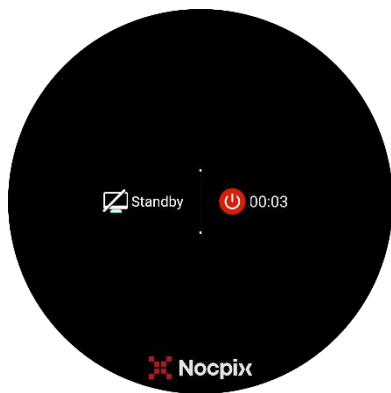

9 Status Bar Icons





- 1.Ultraclear mode status: (🚫 : The Ultraclear mode is off. 👁 : The Ultraclear mode is on.)
- 2.WIFI status (🚫 : Wi-Fi OFF. 📶 : Wi-Fi ON)
- 3.Image calibration status (Ⓐ : Auto Calibration. Ⓜ : Manual Calibration. Ⓑ : Background Calibration)
- 4.MIC status(🚫 : MIC is OFF. 🗣 : MIC is ON)
- 5.RAV status(🚫 : RAV is OFF. 🗣 : RAV is ON)

6. Time (Set it in the Main Menu or synchronize the time in the NOCPPIX APP)

7. Current rifle selected and zeroing distance (Rifles to be selected: A, B, C, D, E, F, G ; zeroing distance: 1~999m.; such as A100m)

8. Current magnification

9. Standby status ( on : Standby mode is ON.  off : Standby mode is OFF);

10. Power status of the replaceable battery (18650 battery)

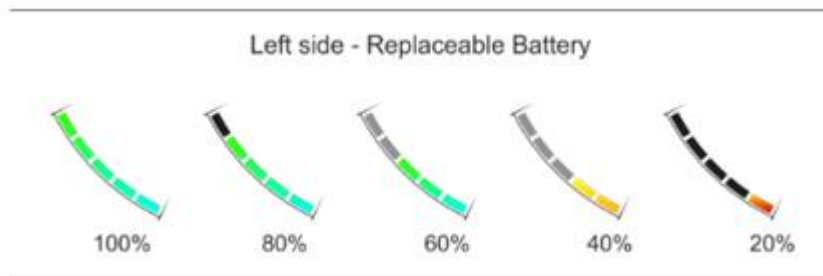

11. Power status of the built-in battery pack

10 Zeroing

ACE series features a "freeze" zeroing method. To zero the ACE:

- Rotate the Controller to enter the "Zeroing Profile" menu, set the zeroing profile to A, B, C, D, E, or F in "Reticle" option.
- Set a suitable target at the desired zero distance.
- Confirm that the rifle is empty, safe, and pointed in a safe direction, with no ammunition near the weapon.
- Based on the distance to the target you wish to zero, select or customize a zero distance to match.
- Ensure a stable platform and natural shooting position is achieved behind the rifle.
- Load ammunition, aim, and take one good shot at the target.



- Make your rifle safe and observe the location of impact on the target.
- If the point of impact does not match the point of aim (the center of the reticle), adjust the X/Y position of the reticle.
- In the submenu for the selected zero distance, center the reticle on the aiming point and freeze the image view.

- Rotate the controller to select the Image Freeze icon.
- Short press the Menu button to freeze the image.



- Adjust the X/Y position of the reticle until the reticle matches the point of impact.
 - Short press the **Menu** button to select X or Y direction. The selected axis will turn from white to blue.
 - Rotate the controller to move the reticle positive.
 - Upon moving the reticle, a red cursor appears on the screen, representing the original position of the reticle.
 - Long press the **Menu** button to save the reticle position.

- Take a confirmation shot. The point of impact should now match the point of aim. If not, adjust the X/Y position of the reticle again.



11 Rangefinder and Ballistic Calculation (Only for ACE H50R / ACE S60R)

ACE H50R and ACE S60R support 1200m laser rangefinder and ballistic calculation functions.

Laser rangefinder

ACE series supports two rangefinder modes: single ranging (SGL) and continuous ranging (CONT).

- On the Home screen, press the Rangefinder button to enable single ranging. Then a rangefinder reticle appears on the screen, and the distance information is displayed on the upper right corner of the screen.
- Long press the Rangefinder button to enable continuous ranging, and the rangefinder information is displayed in real time.



(Single ranging)



(Continuous ranging)

- The measurement accuracy and maximum distance depend on the reflectance of the target surface, the angle at which the emitted beam strikes on the target surface, and the environmental conditions. Reflectance is affected by the target surface texture, color, size, and shape. A glossy or bright surface usually reflects more energy than a dark surface.
- The measurement accuracy is also affected by lighting conditions, fog, haze, rain, snow, and other factors. Light conditions or sunlight will degrade the rangefinder performance.
- Measuring the range of a small-sized target is much more difficult than measuring a large-sized target.

Ballistic calculation

- Press and hold the Menu button to enter the Main Menu. Rotate the Controller to select the Ballistic Calculation option. Within the Ballistic Calculation option, you can set the Ballistic Calculation feature to ON or OFF.
- Within the Profile option, select the bullet profile from 1 to 5. You can also customize the bullet name through the NOCPPIX APP.



- Set the unit to MOA or mil.

- Within the SPOA option, you can sequentially set the Suggested Point of Aim to “x”, “+”, “*”, “.....”; When SPOA is set to Move Reticle, the ACE will automatically move the original reticle to the Suggested Point of Aim.



- Within the **Parameter Setting** option, you can set parameters for bullets, rifles, and the environment. Parameter settings can also be adjusted through the NOCPPIX APP.

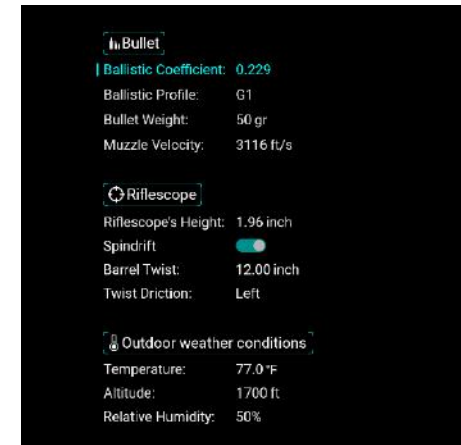

- Once the settings are completed and the Ballistic Calculation is ON, a single ranging will prompt the recommended point of impact.



12 Calibration

When the image is degraded or uneven, it can be improved by calibration. Calibration can equalize the background temperature of the detector and eliminate the image defects (such as vertical bars, phantom images, etc.).



There are three calibration modes: Auto Calibration (A), Manual Calibration (M) and Background Calibration (B).

- Select the required calibration mode in the Main Menu.
- **Auto Calibration (A):** Device will calibrate automatically according to the software algorithm. There is no need to close the lens cover (the internal shutter covers the sensor). Before automatic calibration, there will be a 5 second countdown prompt behind the shutter icon on the status bar, that can be used to cancel this calibration during countdown with a short press of the **Power button**. In this mode, user can also finish the calibration manually with a short press of the **Power button**.
- **Manual Calibration (M):** On the Home screen, press the **Power button** briefly for manual shutter calibration without closing the lens cover.
- **Background Calibration (B):** On the Home screen, press the **Power button**, then a prompt appears on the display as "cover lens during calibration". Cover the lens cap and background calibration will be done after 2s. After calibration, remove the lens cover.



13 Digital Zoom

The **ACE** series supports digital zoom using the Controller.

When PIP is OFF, digital zoom applies to the main screen.

The main screen digital zoom ratio for the ACE series is as follows:

- ACE L35: 4x, 5x, 6x, 7x, 8x, 9x, 10x, 12x, 14x, 16x
- ACE H50: 3x, 4x, 5x, 6x, 7x, 8x, 9x, 10x, 12x, 14x, 16x, 18x, 20x, 22x, 24x
- ACE H50R: 3x, 4x, 5x, 6x, 7x, 8x, 9x, 10x, 12x, 14x, 16x, 18x, 20x, 22x, 24x
- ACE S60R: 2x, 3x, 4x, 5x, 6x, 7x, 8x, 9x, 10x, 12x, 14x, 16x, 18x, 20x, 22x, 24x

When PIP is ON, digital zoom applies only to the PIP screen.

The PIP digital zoom ratio for the ACE series is as follows:

- ACE L35: 8x, 10x, 12x, 14x, 16x, 18x, 20x, 24x, 28x, 32x
- ACE H50: 6x, 8x, 10x, 12x, 14x, 16x, 18x, 20x, 24x, 28x, 32x, 36x, 40x, 44x, 48x

- ACE H50R: 6x, 8x, 10x, 12x, 14x, 16x, 18x, 20x, 24x, 28x, 32x, 36x, 40x, 44x, 48x
- ACE S60: 4x, 6x, 8x, 10x, 12x, 14x, 16x, 18x, 20x, 24x, 28x, 32x, 36x, 40x, 44x, 48x

14 Ocular Zoom

The ACE series supports Ocular zoom, achieved by rotating the **Ocular zoom ring**. The Ocular zoom range is 1x~3x;

The Ocular zoom ratio is not displayed on the screen.

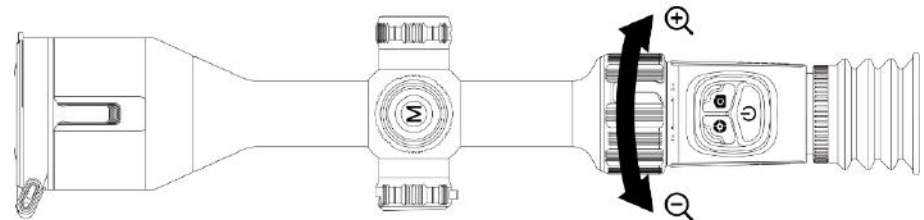

15 Photo and Video Recording

The ACE series supports photo and video recording. Press the **Photo button** to take a picture, press and hold the **Photo button** to record a video.

Each time a photo is taken, the camera icon on the display will flash once.

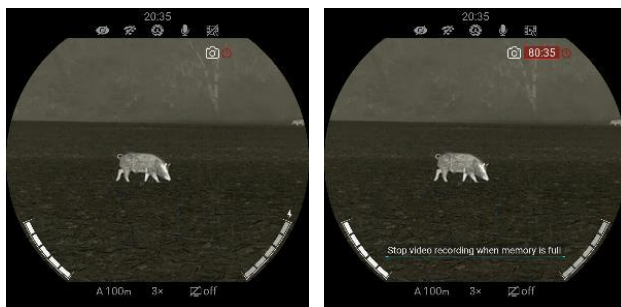

Each time a video is recorded, a camcorder icon will appear on the display, along with the recording time.

When the device's memory space is less than 50MB, an exclamation mark icon will appear, indicating insufficient memory space. Please clear the memory space promptly.



Memory access

When the device is powered on and connected to a computer, it will be recognized by the computer as a flash memory card. Then, you can access the memory of the device and copy images and videos.

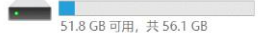
- Connect the device to a computer through the USB cable.
- Power on the device.
- Double-click My Computer - Double-click to open the device named NOCPPIX  - Double-click to open the device name ACE  to access the memory. 
- There are different folders named by date in the format of xxxx (year) xx (month) xx (day) in the memory.
- Recorded photos and videos in that day are saved in the folders.
- Select desired files or folders to copy or delete..





16 Shortcut Menu







On the main menu screen, press the Menu button to enter the Shortcut Menu options.

On the Shortcut Menu, rotate the Controller to switch between different Shortcut Menu options, and press the Menu button to adjust the parameters of the Shortcut Menu.

If there is no operation for 7 seconds, the Shortcut Menu will exit automatically.

You can also exit the Shortcut Menu screen by pressing and holding the Menu button or pressing the Power button.

<p>Color Mode</p> 	<ul style="list-style-type: none"> ● Short press the Menu button to enter the shortcut Menu options; ● Within the Color Mode options, short press the Menu button to switch between different color modes. ● The color modes include: White Hot, Black Hot, Red Hot, Rainbow, Violet, Crimson, and Viridian. ● Note: Only the ACE H50R/ ACE S60R models have the Color Mode option in Shortcut Menu. 	
<p>Screen Brightness</p> 	<ul style="list-style-type: none"> ● Short press the Menu button to enter the shortcut Menu options; ● Rotate the controller to switch to Screen Brightness options; ● Within the Screen Brightness options, short press the Menu button to switch between different screen brightness levels. ● Screen brightness has 10 levels to choose from, we recommend a screen brightness of 5. 	

<p>Image Contrast</p> 	<ul style="list-style-type: none"> ● Short press the Menu button to enter to the Image Contrast options; ● Rotate the controller to switch to Image Contrast options ● Within the Image Contrast options, short press the Menu button to switch between different Image Contrast levels. ● Image Contrast has 10 levels to choose from, we recommend a contrast level of 5. 	
<p>Image Sharpness</p> 	<ul style="list-style-type: none"> ● Short press the Menu button to enter to the Image Sharpness options; ● Rotate the controller to switch to Image Sharpness options ● Within the Image Sharpness options, short press the Menu button to switch between different sharpness levels. ● Image Sharpness has 10 levels to choose from, we recommend a sharpness level of 5. 	
<p>Zeroing Distance</p> 	<ul style="list-style-type: none"> ● Short press the Menu button to enter the shortcut menu options; ● Rotate the controller to switch to Zeroing Distance options; ● Within the Zeroing Distance options, short press the Menu button to switch between different zeroing distances. ● Note: You can only switch the zeroing distances that have already been zeroed. 	

17 Main Menu



Press and hold the **Menu** button to open the **Main Menu**;

Within the **Main Menu** options, rotate the controller to switch between different main menu options. Icons change from white to blue when a Main Menu option is selected.

Press the **Menu** button to adjust the parameter settings of the **Main Menu**;

If there is no operation for 7 seconds, the **Main Menu** will exit automatically. You can also exit the **Main Menu** screen by pressing and holding the **Menu** button or pressing the **Power** button.

Within the **Main Menu** options, you can perform the following settings:

<p>Ultra Clear</p> 	<ul style="list-style-type: none"> ● Press and hold the Controller to enter the Main Menu interface. ● Rotate the Controller to switch to the Ultra Clear option; ● Within the Ultra Clear option, press the Menu button to enable or disable the Ultra Clear mode. <p>Note: We recommend to enable Ultra Clear mode on cloudy and rainy days to effectively enhance image quality.</p>	
--	---	--







Reticle

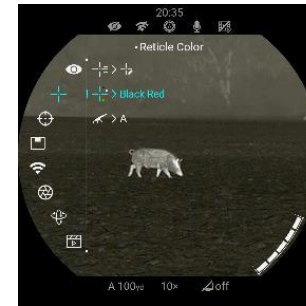
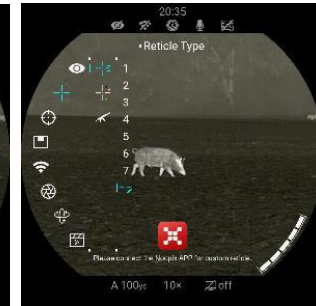
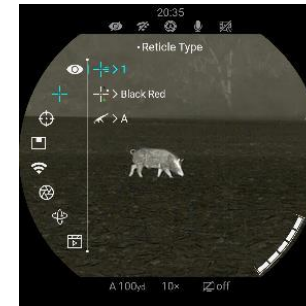









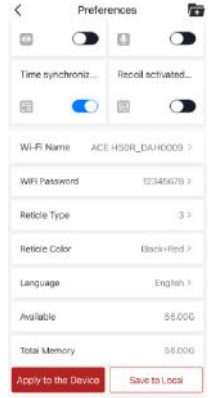





- Press and hold the Controller to enter the Main Menu interface.
- Rotate the Controller to switch to the Reticle option.
- Within the Reticle option, there are three submenu options:
 1. Reticle Type
 2. Reticle Color
 3. Zeroing Profile
- Within the Reticle Type option, there are 7 reticle styles to choose from. Type 8 allows users to customize their own reticle types via the APP.
- Within the Reticle Color option, there are 8 reticle colors to choose from: Black Red, Black Green, White Red, White Green, Black White, White Black, Red, and Green.
- Within the Zeroing Profile option, there are A/B/C/D/E/F/G, a total of 7 rifle types to choose from.
- If you switch to a rifle type that has not been zeroed, it will prompt "There is no zeroing data for this gun. Please use it after zero"







Notes: The zeroing profile can be customized and named via the APP.

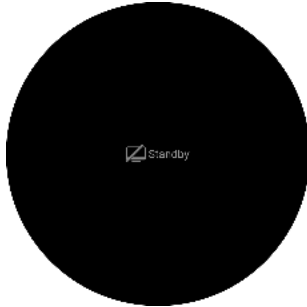

<p>Zeroing</p> 	<ul style="list-style-type: none"> ● Press and hold the Controller to enter the Main Menu interface. ● Rotate the Controller to switch to the Zeroing option. ● Within the Zeroing option, press the Menu button to enter Zeroing. ● Please refer to the “Zeroing” section for detailed guidance for zeroing. 	
<p>PIP</p> 	<ul style="list-style-type: none"> ● Press and hold the Controller to enter the Main Menu interface. ● Rotate the Controller to switch to the PIP option. ● Within the PIP option, press the Menu button to enable or disable PIP mode. 	
<p>WIFI</p> 	<ul style="list-style-type: none"> ● Press and hold the Controller to enter the Main Menu interface. ● Rotate the Controller to switch to the WIFI option. ● Within the WIFI option, press the Menu button to enable or disable WIFI. ● After the Wi-Fi function is on, search for the Wi-Fi signal with the name "ACE H50R_XXXXXXX" on the mobile device. ● Select the Wi-Fi and enter the password to connect. The initial password is 12345678. ● When Wi-Fi is successfully connected, it supports to control the scope via the NOCPPIX APP downloaded in the mobile device. ● Setting Wi-Fi name and password 	

	<ul style="list-style-type: none"> ● The name and password of the Wi-Fi in ACE series can be reset on the Nocpix app. ● After the scope is connected to a mobile device, locate and click the 'Settings' icon on the Nocpix image screen to enter the WiFi setting interface ● In the text box, enter and submit the new Wi-Fi name (SSID) and password. ● It needs to reboot the device to take the new name and password effect. <p>Note: If the device is reset to the factory settings, the name and password of the Wi-Fi will also be restored to the default settings.</p>	
<p>Calibration</p> 	<ul style="list-style-type: none"> ● Press and hold the Controller to enter the Main Menu interface. ● Rotate the Controller to switch to the Calibration option. ● Within the Calibration option, you can select 3 calibration types, including: Auto Calibration (A) Manual Calibration (M) Background Calibration (B) ● Please refer to the Calibration section for detailed guidance for zeroing. 	
<p>Motion Sensor</p> 	<ul style="list-style-type: none"> ● Press and hold the Controller to enter the Main Menu interface. ● Rotate the Controller to switch to the Motion Sensor option. ● Within the Motion Sensor option, press the Menu button to enable or disable the Motion Sensor. ● When the motion sensor is on, the horizontal scale representing the tilt angle is displayed on the left side, the vertical scale representing the pitch angle is displayed on the right side. 	



<p style="text-align: center;">Gallery</p> 	<ul style="list-style-type: none"> ● Press and hold the Controller to enter the Main Menu interface. ● Rotate the Controller to switch to the Gallery option. ● Within the Gallery, video and photo files are arranged in folders by date. ● After entering a folder, select a video file, and press the M button to play the video file. 	 
<p style="text-align: center;">Ballistic Calculation</p> 	<ul style="list-style-type: none"> ● Press and hold the Controller to enter the Main Menu interface. ● Rotate the Controller to switch to the Ballistic Calculation option. ● Please refer to the "Rangefinder and Ballistic Calculation" section for detailed guidance. <p>Notes: Only ACE H50R and ACE S60R have Ballistic Calculation function</p>	
<p style="text-align: center;">Image Hue</p> 	<ul style="list-style-type: none"> ● Press and hold the Controller to enter the Main Menu interface. ● Rotate the Controller to switch to the Image Hue option. ● Within the Image Huge option, press Menu button to choose Warm Hue () or Cool Hue (). ● Cold hue mode Image will be more contrast, more hierarchy, and more obvious targets. ● Warm hue mode Image will be softer. It can reduce the visual fatigue of the observer, and long time observation is not dazzling. <p>Notes: The default setting is Cool Hue.</p>	

<p>Recoil Activated Video</p> 	<ul style="list-style-type: none"> ● Press and hold the Controller to enter the Main Menu interface. ● Rotate the Controller to switch to the Recoil Activated Video option. ● Within the Recoil Activated Video option, press the Menu button to enable or disable the RAV function. ● When RAV is enabled, shooting automatically triggers video recording. The device saves video footage 5 seconds before and 3 minutes after the shot. ● During recording, press and hold the Photo button to exit the recording function. 	
<p>Standby</p> 	<ul style="list-style-type: none"> ● Press and hold the Controller to enter the Main Menu interface. ● Rotate the Controller to switch to the Standby option. ● Within the Standby option, press the Menu button to enable or disable the standby function. ● When Standby is enabled, the device automatically enters Standby mode to save power when the vertical tilt angle exceeds 70° or the horizontal tilt angle exceeds 30°. 	 
<p>Microphone</p> 	<ul style="list-style-type: none"> ● Press and hold the Controller to enter the Main Menu interface. ● Rotate the Controller to switch to the Microphone option. ● Within the Microphone option, press the Menu button to enable or disable the Microphone function. ● The Microphone icon is displayed on the status bar. 	

Pixel Defect Correction









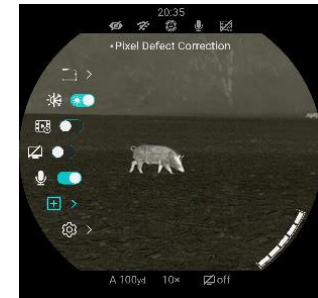

When using the scope, you may see pixel defects, such as visible light spots or dark spots with stable brightness. To address this problem, use the Pixel Defect Correction function to remove the pixel defects.

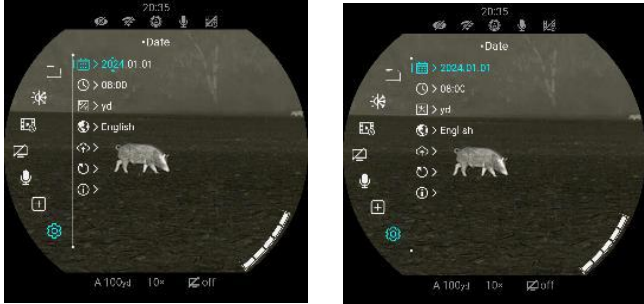







- Press the Controller to enter the Pixel Defect Correction interface.
- The PIP function is automatically turned on, and display on the top of the screen by default. The moving directions (X-axis and Y-axis) and the numbers of corrected pixels are shown on the left side of the screen.
- In the Pixel Defect Correction interface, the reticle is instead by a small cross cursor.
- Rotate the Controller to move along the direction selected, rotate it clockwise to move leftward or downward, and rotate anticlockwise to move rightward or upward. When the X or Y direction is selected, the icon will flash continuously.
- Press the Menu button to save moving data and select the  icon to add and correct it. The value of  will be changed from "0" to "1". At the same position, press the Menu button again to revoke the defect pixel correction and the value will be changed from "1" to "0".
- Rotate the Controller to select 'Yes' to save and exit, or select 'No' to cancel saving and exit.
- Press the Controller briefly to confirm the selection.



You can also choose the automatic defective pixel calibration function by short press  icon.



		<ul style="list-style-type: none"> ● Press and hold the Controller to enter the Main Menu interface. ● Rotate the Controller to select the Setting option. ● Press the Controller briefly to enter the submenu. ● This menu item allows you to configure the following settings. ● Press and hold the Controller to enter the Main Menu interface. ● Rotate the Controller to select the Setting option. ● Press the Controller briefly to enter the submenu. ● This menu item allows you to configure the following settings. 	
<p style="text-align: center;">Setting</p> 	<p style="text-align: center;">Date</p> 	<p>Set system date</p> <ul style="list-style-type: none"> ● Within the Date option, short press the Menu button to switch the Year / Month / Day option; ● Rotate the controller to adjust the value of Year / Month / Day. ● After the adjustment is completed, press and hold the Menu button to save and exit Date option. 	

<p style="text-align: center;">Time</p> 	<p>Set system time</p> <ul style="list-style-type: none"> ● Within the Time option, short press the Menu button to switch the Hour / Minute option; ● Rotate the controller to adjust the value of Hour / Minute. ● After the adjustment is completed, press and hold the Menu button to save and exit Time option. 	 
<p style="text-align: center;">Languages</p> 	<p>Set system languages</p> <ul style="list-style-type: none"> ● Within the Languages option, rotate the controller to switch different languages. ● Languages available for the ACE series include English, German, Spanish, Italian, French, Swedish, Norwegian, Polish, Czech, Slovak, Hungarian, and Dutch. ● After the adjustment is completed, press and hold the Menu button to save and exit Languages option. 	 

<p style="text-align: center;">Unit</p> 	<p>Set system unit</p> <ul style="list-style-type: none"> ● Within the Unit option, rotate the controller to switch the unit of Meter or Yard. ● Press Menu button to select Meter / Yard. ● After the adjustment is completed, press and hold the Menu button to save and exit Unit option. 	 
<p style="text-align: center;">Firmware Update</p> 	<p>Firmware Update</p> <ul style="list-style-type: none"> ● Within the Firmware Update option, ● you can use the manufacturer-provided specific file to update the system firmware. Of course, you can also upgrade the system through the NOCPPIX APP. <p>Notes: When using the firmware update function, please strictly follow the manufacturer's instructions. Please refer to the "FW Updates and APP" section for detailed guidance for FW update by APP.</p>	 
<p style="text-align: center;">Factory Reset</p> 	<p>Factory reset</p> <ul style="list-style-type: none"> ● Within the Factory Reset option, you can use Menu button ant Controller to set ACE to factory default settings. 	 

	<p>Info</p> 	<p>System information</p> <ul style="list-style-type: none"> ● Within in the Info option, you can press the Menu button to enter the Info interface to View the device information. 	
--	--	---	---

18 FW Updates and APP

The ACE series Thermal Imaging Scope allows you to transmit images to a smartphone or tablet via Wi-Fi in real time mode.

Continuous improvements will be made to improve the user experience. The latest programs can be automatically detected and updated via the Nocpix APP.

Also, it is feasible to download and update from the official website: www.nocpix.com.

About Nocpix

You can download and install the Nocpix APP on the official website (www.nocpix.com) or the app store. Alternatively, you can scan the QR code below to download it for free.

- Open the Nocpix APP after installation.
- If your device has been connected to a mobile device, please turn on the mobile data of the mobile device. After connection, an update prompt will be displayed automatically on the App.
- Nocpix automatically registers the last connected device. Therefore, once you have connected with Nocpix before, it will automatically detect the update even when the scope is not

connected to the mobile device.

- If an update is available and the mobile device accesses the Internet, you can download the update first. Then when the device is connected with the mobile device, it will be updated automatically.
- After the update is installed, the device will restart automatically.

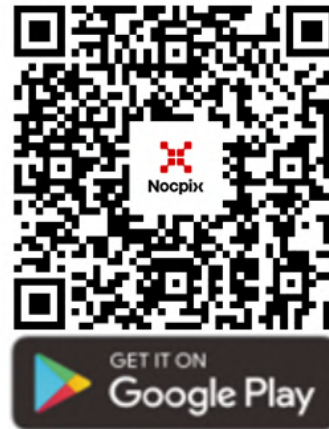

19 Maintenance

The maintenance should be carried out at least twice a year and includes the following steps:

- Wipe the surface of metal and plastic parts to clear off dust and dirt by using a cotton cloth. Silicone grease may be used for the cleaning process.
- Clean the electric contacts and battery slots on the device using a non-greasy organic solvent.
- Check the glass surface of the eyepiece and lens. If necessary, clear off the dust and sand on the lens (it is perfect to use a non-contact method). Use a specialized wiping tool and solvent to clean the optical surfaces.

20 Troubleshooting

The following table lists all problems that are likely to occur during device operation. Check and address problems by referring to this table. If faults not included in this table occur or you cannot fix the fault, return the device to its vendor or supplier for troubleshooting.

Fault	Possible Causes	Solution
The scope cannot be started.	The battery is out of charge.	Charge the battery.
The device cannot be powered by using an external power supply.	The USB cable is damaged.	Replace the USB cable.
	The external power supply is insufficient.	If necessary, check the external power supply.
Images are unclear, vertical lines are present, or the background is not even.	Calibration is required.	Calibrate the images as instructed in this User Manual.
The image is too dark.	The screen is not bright enough.	Adjust the display brightness.
The icons are clear but the image is blurry.	The lens is not focused.	Rotate the lens focus ring to adjust the focus.
	The inner or outer optical surface of the lens is dusted or iced.	Wipe the outer optical surface by using a soft cotton cloth or leave the scope to dry in a warm and dry environment for more than 4 hours.
The scope cannot focus.	Wrong settings.	Set the scope according to the contents of section Power-on and Settings in this user manual. Check the outer surface of the objective lens and eyepiece, and if necessary, wipe off any dust and frost on it.

		In cold weather, a special antifogging coating can be applied (such as those used on eyeglasses or car rearview mirrors).
The device cannot connect to the mobile device.	The Wi-Fi password is incorrect.	Enter the correct password.
	Too many Wi-Fi networks around the device.	Move the device to an area with no or fewer Wi-Fi signals.
Wi-Fi signals are lost or interrupted.	The device is beyond Wi-Fi coverage. There is blocking (such as concrete walls) between the device and the receiver.	Move the device to a place where you can receive Wi-Fi signals.
The observed target disappears.	Observation through glass.	Observe the target directly without the presence of glass.
The image quality is poor or the detection range is shortened.	These problems are likely to occur when you use the device in harsh weather (such as snow, rain, and fog).	
When the device is used at a low temperature, the imaging quality is poorer than that at a normal temperature.	<p>At temperatures above 0°C, the temperature rise varies with the observed objects (environment and background) due to different heat conductivity coefficients. As a result, high-temperature contrast occurs and the image quality is better.</p> <p>At low temperatures, the observed targets (background) usually cool down to a similar temperature because of reduced temperature contrast. Therefore, the image quality (details) is poor, which is a characteristic of thermal imaging devices.</p>	

21 Legal and Regulatory Information

Wireless transmitter module frequency range:

WLAN: 2.412-2.472 GHz

Wireless transmitter module power < 20 dBm



We Inlumen Technologies Co., Ltd. hereby declares that the radio equipment types ACE is in compliance with the Directives 2014/53/EU and 2011/65/EU

FCC Statement

FCC ID: 2BHFB-ACE-00

Labeling requirements

This device complies with part 15 of the FCC Rules. Operation is subject to the following two conditions: (1) This device may not cause harmful interference, and (2) this device must accept any interference received, including interference that may cause undesired operation.

Information to the user

Any Changes or modifications not expressly approved by the party responsible for compliance could void the user's authority to operate the equipment.

EMC: Class A

Note: This equipment has been tested and found to comply with the limits for a Class A digital device, pursuant to part 15 of the FCC Rules. These limits are designed to provide reasonable protection against harmful interference when the equipment is operated in a commercial environment. This equipment generates, uses, and can radiate radio frequency energy and, if not installed and used in accordance with the instruction manual, may cause harmful interference to radio communications. Operation of this equipment in a residential area is likely to cause harmful interference in which case the user will be required to correct the interference at his own expense.

To comply with RF exposure requirements, a minimum separation distance of 0.00 cm must be maintained between the user's body and the handset, including the antenna.



 **Manufacturer:** Inlumen Technologies Co., Ltd.

 **E-mail:** service@nocpix.com

 **Website:** www.nocpix.com

 **Address:** North 6F, Building B3, Hefei Software Park, No.800 Wangjiang West Road, Hefei National High-tech Industry Development District, Anhui, China.