

LUMI

Thermal Imaging monocular



User Manual

LUMI P13 / LUMI L19 / LUMI L35 / LUMI H35

V1.0

1 Specification

Model	LUMI P13	LUMI L19	LUMI L35	LUMI H35
Thermal Sensor,pixels	256×192,12μm	384×288,12μm	384×288,12μm	640×512,12μm
NETD,mK	≤20	≤18	≤18	≤18
Frame rate,Hz	50	50	50	50
Objective lens,mm	13 F0.9	19 F0.9	35 F0.9	35 F0.9
Field of view(H×V),°/m@100m	13.5×10.1/24×18	13.8×10.4/24×18	7.5×5.7/13×10	12.5×9.4/22×16
Magnification,×	2~8	2~8	4~16	2.5~20
Detective range,m(Target size:1.7m×0.5m,P(n)=99%)	670	980	1800	1800
Exit relief,mm	25			
Exit pupil diameter,mm	10			
Diopter,D	-5~+5			
Display	AMOLED 1024×768			
Battery Type	Replaceable li-ion battery 18650			
Max.operation time,h	6	4.5	4.5	4.5
MIC	Support			
Memory capacity,GB	32			
IP rating	IP67			
Operating temperature,°C	-20 ~ +50			
Weight,g(with battery)	310	335	335	345
Dimension,mm	134×47×74	139×47×74	143×47×74	143×47×74

★ The actual operating time depends on the density of Wi-Fi use, photographing, video recording, etc.

➤ Improvements may be made to the design and software of this product to enhance its features without prior notice to the customer.

2 Package Contents

- LUMI series Thermal Imaging Monocular
- Portable bag
- 18650 Battery × 2
- 18650 battery charger
- Data cable
- Neck Strap
- Lens cleaning cloth
- Quick start guide

3 Description

The LUMI series thermal imaging monoculars are designed for use both at night-time and during the day and provide exceptional image quality even in adverse weather conditions (fog, smog, rain) and beyond obstacles like branches, tall grass, dense foliage, etc. known to hinder target detection.

It has a very small size and light weight, making it easy to carry

LUMI thermal imagers are designed for various applications including hunting, observation, security, terrain orientation, search and rescue operations, etc.

4 Features

- Compact and lightweight
- 12 μ m detector
- F0.9 objective lens
- AMOLED 1024 \times 768
- Rechargeable Battery 18650 for quick replacement
- 50Hz high frame rate
- Smooth digital zoom
- Ultraclear mode
- Eye protection with low brightness, color palette and warm hue
- Electronic image stabilization

5 Components and Buttons



1. Eyeshade

2. Eyepiece

3. Down button

4. Menu(M) button

5. UP button





6. Power(P) button

7. Lens focus ring

8. Battery compartment cover

9. Type-C port

6 Button Operations

Button	Current Status	Short Press	Press and Hold
Power button 	Powered off	---	Power on the device
	Home screen	Standby the device	Power off the device
	Standby mode	Wake up the device	Wake up the device
	Shortcut menu interface	Return to the upper menu with saving changes	Power off the device
	Main menu interface	Return to the upper menu without saving changes	Power off the device
Up button 	Home screen	Digital zoom	Turn on/off the PIP function
	Shortcut menu interface	Navigation upwards	---
	Menu interface	Navigation upwards	---
Menu button 	Home screen	Open the shortcut menu	Go to the main menu
	Shortcut menu interface	Switch and confirm parameters	Save and back to the home screen
	Main menu interface	Enter the submenu / Switch and confirm parameters	Save and back to the home screen
Down button 	Home screen	Take a photo	Start a video recording
	Video recording	Take a photo	Stop and save the video
	Shortcut menu interface	Navigation downwards	---
	Menu interface	Navigation downwards	---
Up + Down buttons	Home screen	Shutter calibration	Background calibration

7 Battery charging

The LUMI series uses the rechargeable lithium-ion Battery 18650. Please charge the Battery before use.

Charging with Battery Charger

- Align the pins of the Battery with the groove of the battery charger, and insert the Battery into the battery charger .
- Connect the Type-C plug of the data cable to the port of the battery charger.
- Connect the other plug of the data cable to the USB port of the power adapter.
- Insert the power adapter to a 100V - 240V power socket to charge the Battery.
- Upon installation, the LED indicator on the Battery charger will start to glow.
 - If the indicator is steady red, the Battery is being charged.
 - If the indicator turns green, the Battery is fully charged.
 - If the indicator blinks red, the battery charging holder is connected to the power source but there is no installed Battery.
- After fully charged, remove the Battery Pack from the battery charger .

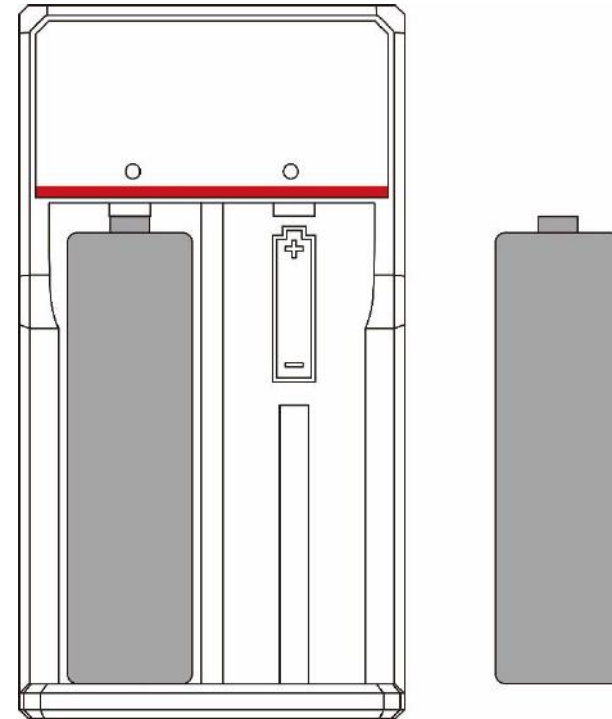

Battery Installation

- Pull down the button under the eyepiece, Open the battery compartment cover.
- Both positive and negative battery connections can provide power,Both positive and negative battery connections can provide power.
- Close the battery compartment cover and Pull the button up.

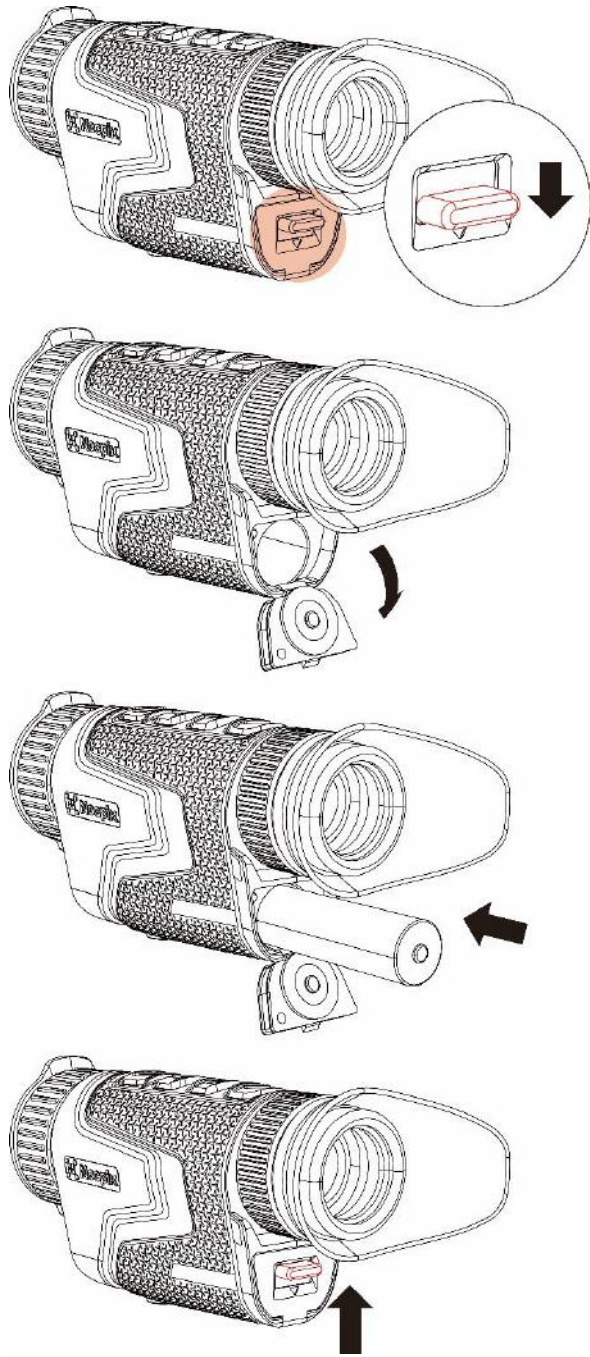

Precautions for Battery

- **After a long storage time, the battery should be partially charged, not fully charged or discharged.**
- Do not charge the battery immediately after you bring it from the cold environment to the warm environment. Wait 30 to 40 minutes for it to warm up.
- Do not charge the battery unsupervised.
- Do not use the charger if it is modified or damaged.
- Charge the battery in the environment of 0°C to +45°C. Otherwise, the service life of the battery will be reduced.
- Charging time should not exceed 24 hours.
- Do not expose the Battery to high temperature or a naked flame.
- Do not immerse the Battery in water.
- Do not connect external device with a current consumption that exceed permitted levels.
- The Battery is equipped with a short circuit protection function. However, any situation that may cause short-circuiting should be avoided.
- Please do not disassemble or modify the Battery without professional instructions.
- Do not knock or drop the Battery.
- The battery capacity may decrease when using the battery in negative

temperature, that is normal, not a defect.

- Avoid using the Battery at the temperature above the temperature shown in the table, this may decrease the battery's life.
- Please keep the Battery out of the reach of children.

8 External Power Supply

The LUMI series can be powered with an external power supply, such as a Power Bank (5V).

- Connect the external power supply to the Type-C port on the bottom of the LUMI series.
- The device will switch to the external power supply
- If the device is connected to an external power source, the battery icon will be changed to the USB icon .
- When the external power supply is disconnected, the LUMI series will automatically switch to the Battery Pack without powering off.

9 Power On/Off and Image Settings

- Power On: Remove the lens cap. Press and hold the **Power button** to power on the device. Then, the home screen is displayed after several

seconds.

- Rotate the eyepiece diopter ring until the image becomes clear in the eyepiece. After the adjustment, it no needs to be adjusted for the same user.
- Rotate the focusing ring of the objective lens to focus on the object to be observed.
- To set the image mode, display brightness, image sharpness, image contrast, refer to the **Shortcut Menu** section in this manual.
- Power Off: After use, press and hold the Power button and a shutdown countdown is displayed. Then release your finger. During the process, press any key can cancel the shutdown.

10 Update and NOCPPIX APP

Client Software Connection

The LUMI series thermal imaging monocular supports control with **NOCPPIX** App, which allows you to transmit images in real time, operate the device, and update the program by connecting a smartphone or laptop via Wi-Fi.

You can download and install the NOCPPIX App In the official website (www.nocpix.com) or the app store. Alternatively, you can scan the QR code below to download it for free.



The LUMI series has a built-in Wi-Fi module. The device can connect to an external apparatus (computer or mobile phone) via Wi-Fi.

- In the home screen, press and hold the **M button** to go to the main menu. enable the Wi-Fi on the device.
- After the Wi-Fi is enabled, search for the Wi-Fi named **Model_XXXXXXX** on the external device, among which XXXXXXX is the serial number of the device. Select the Wi-Fi, enter the password and connect. The initial password is **12345678**.
- After the Wi-Fi connection is established, you can control the device via the mobile app.

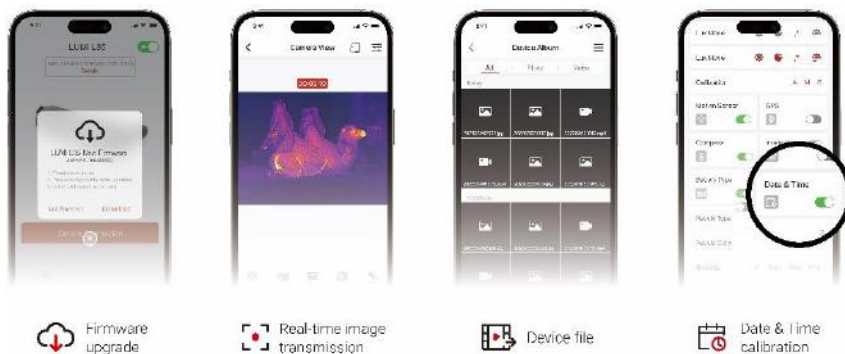

Upgrade Device

- When installation completed, open NOCPPIX application.
- If your device has been connected to a mobile device, please switch on the mobile data in mobile device. After connection, an update prompt will be displayed automatically in the APP. Click **Now** to download the latest version immediately or click **Later** to update later.
- **NOCPPIX** can store the last connected device automatically. Therefore, once you have connected with **NOCPPIX** before, it will automatically detect the update even when the scope is not connected to a phone or laptop.
- If an update is available and the mobile device accesses the internet, you can download the update first. Then when the device is connected with the mobile device, it will be updated automatically.
- After the update is installed, the device will restart automatically.

11 Shortcut Menu

On the shortcut menu, you can quickly adjust basic configurations of commonly used functions, including the image mode, display brightness, image sharpness, and image contrast.

- In the home screen, press the **M button** to go to the shortcut menu.
- Press the **Up / Down** button to switch the following options.
 - **Image mode:** Press the **M button** to change the image mode (white hot, black hot, red hot, color, and highlight).
 - **Image brightness:** Press the **M button** to change the image brightness from level 1 to level 10.
 - **Image sharpness:** Press the **M button** to change the image sharpness from level 1 to level 10.
 - **Image contrast:** Press the **M button** to change the image contrast from level 1 to level 10.
- Press and hold the **M button** to save the changes and return to the home screen.
- In the shortcut menu, if there is no operation within 7s, the device will automatically save the changes and return to the home screen.

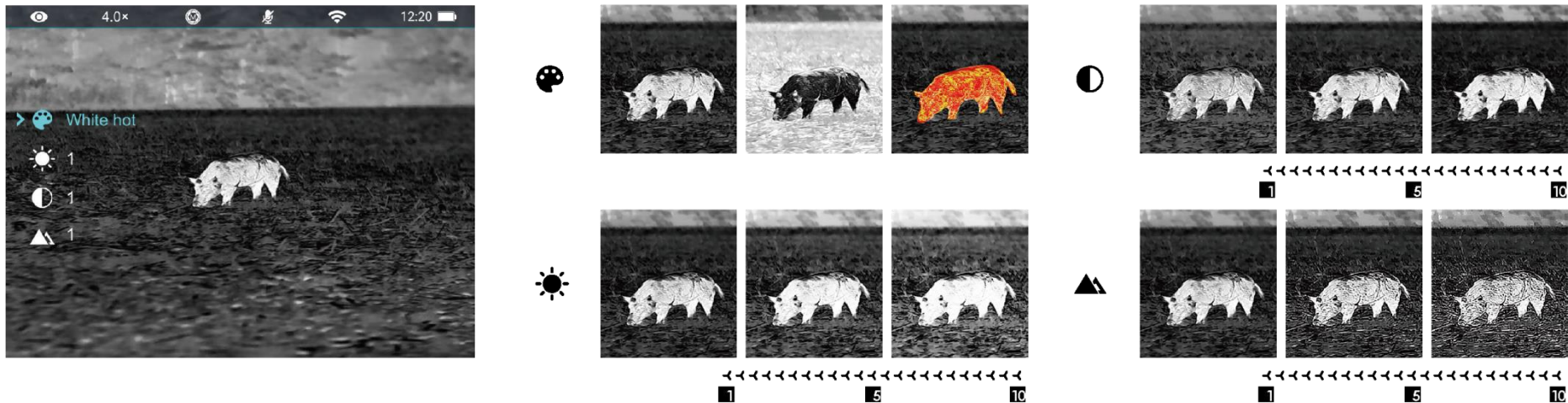



12 Main Menu

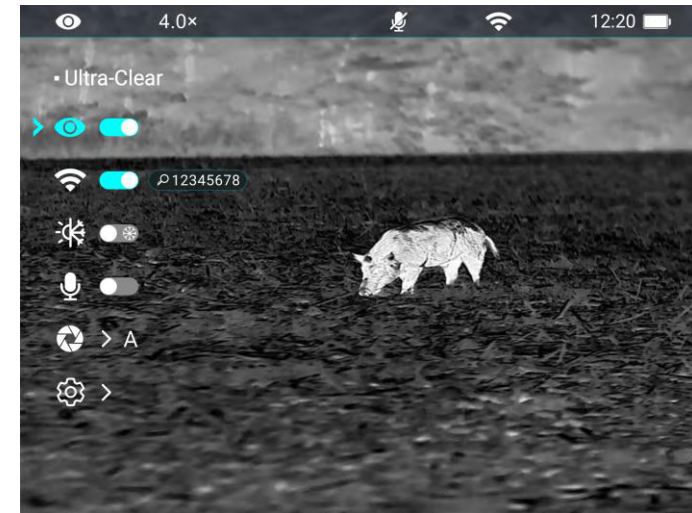



- In the home screen, press and hold the **M button** to go to the main menu.
- Press the **Up / Down** button to switch the menu options.
- The function options in the main menu are cyclical: when the arrow **>** reaches the last option on the first page, it will turn to the first menu option on the second page. When the arrow **>** is on the first option of the first page, press the **Up** button to switch to the last option of the second page.
- Press the **M button** to modify the parameter settings of the current menu option or to open the submenu.
- In the second and third-level submenu, press the **Up / Down** button to choose a parameter or function; press the **M button** to confirm the selection. An icon flashes, indicating the changes are being saved, and then the upper menu or the submenu is displayed.
- In any menu interface, press the **Power button** to return to the upper menu or home screen without saving the changes, and press and hold the **M button** to save the changes and return to the home screen.
- In any menu interface, the device will automatically return to the home

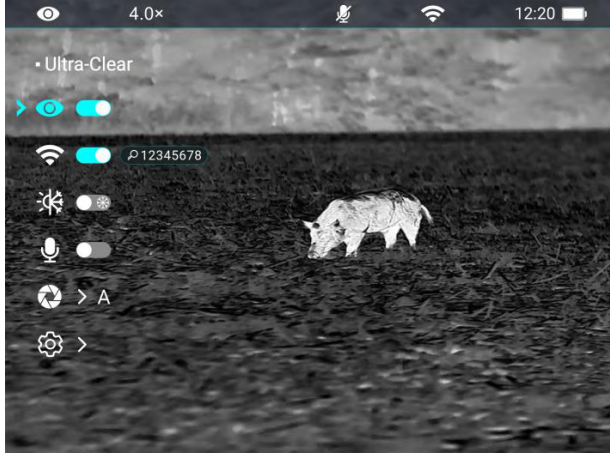

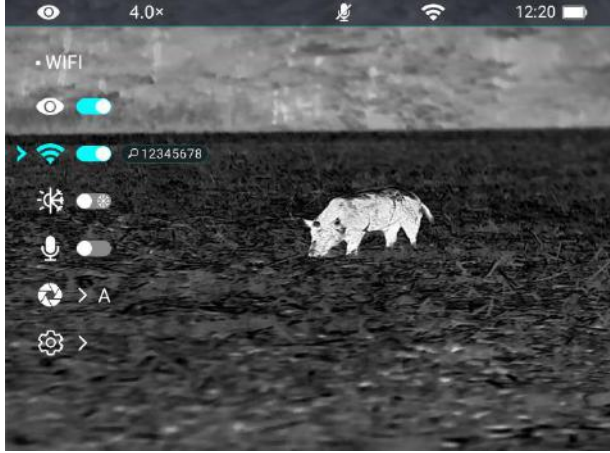
- screen without saving the changes when there is no operation within 15s.
- During the continuous operation of the thermal imaging monocular, when you exit from the main menu, the cursor **>** remains at the position before exiting. When you restart the thermal imaging monocular and go to the main menu for the first time, the cursor stays at the first menu option.

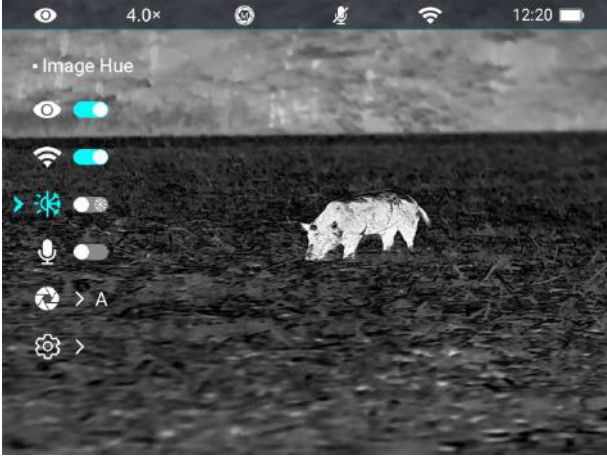
Main Menu Options and Descriptions

<p>Ultra-clear</p> 	<p>Turn the Ultra-clear mode on/off</p> <ul style="list-style-type: none"> ● Press and hold down the M button to enter the main menu. ● Select the Ultra-clear menu option with the Up / Down button. ● Turn the Ultra-clear mode on /off with a short press of M button, during which you will hear a click of shutter calibration. ● When the function is turned on/off, the icon on the status bar changes accordingly. ● When the Ultra-clear mode is on, the image contrast is enhanced, which is suitable for rainy, foggy and other harsh weather conditions. 	
<p>Wi-Fi</p> 	<p>Turn Wi-Fi on/off</p> <ul style="list-style-type: none"> ● Press and hold down the M button to enter the main menu. ● Press the Up / Down button to select the Wi-Fi option. ● Turn the Wi-Fi on /off with a short press of M button. ● When Wi-Fi is on, the default password is prompted for 3s behind the icon of Wi-Fi. ● The default password is 12345678. After the password is changed, it will not be displayed. ● When the function is turned on/off, the icon on the status bar changes accordingly. 	

<p style="text-align: center;">Image Hue</p> 	<p>Set the image hue</p> <ul style="list-style-type: none"> ● Press and hold down the M button to enter the main menu. ● Press the Up / Down button to select the Image Hue option. ● Press the M button to switch the Image Hue between W (warm) and C (cool). ● Cool hue image is brighter and warm hue image is softer and eye protection. ● The switch between the warm and cool hues is not applicable to the color palettes. 	
<p style="text-align: center;">Microphone</p> 	<p>Turn MIC on/off</p> <ul style="list-style-type: none"> ● Press and hold down the M button to enter the main menu. ● Press the Up / Down button to select the MIC option. ● Press the M button to turn MIC on/off. ● After MIC is on, the device will record sound during video recording. 	
<p style="text-align: center;">Calibration</p> 	<p>Set the calibration mode</p> <p>In rare cases, once the image is degraded or uneven, it can be improved by calibration. There are two calibration modes: Automatic and Manual. Regardless of which mode you are in, you can manually operate Shutter calibration and background calibration.</p> <ul style="list-style-type: none"> ● Press and hold down the M button to enter the main menu. ● Press the Up / Down button to select the Calibration option. 	

- Press the **M** button to enter the submenu of the **Calibration** function.
- Press the **Up / Down** button to switch the selection between **Automatic** and **Manual**.
 - **Automatic** : It is defined by software algorithms. When the Image quality deteriorates, it will be calibrated automatically in this mode.
 - **Manual Calibration**: Images are calibrated by the user according to the image effect. You need to press the **Up button + Down button** at the same time to perform the calibration.
- Press the **M** button to confirm your selection. The icon on the status bar changes accordingly.



Shutter Calibration

Background Calibration



Manual



Automatic

Gallery



View video/photo files in the device

- Press and hold down the **M** button to enter the main menu.
- Press the **Up / Down** button to select the **Gallery** option.
- Press the **M** button to enter the **Gallery** function.
- When there are a large number of files, there is a file cache time after entering the function
- In each interface, the operation logic of the buttons is as follows



		Folder interface	File interface	View interface
Power button	Short press	Return to the upper menu	Return to the upper menu	Return to the upper menu
Up button	Short press	Navigation upwards	Navigation upwards	Backward
	Press and Hold	Previous page	Previous page	/
Menu button	Short press	Enter folder	View file	Pause/Play
	Press and Hold	Back to the home screen	Back to the home screen	Back to the home screen
Down button	Short press	Navigation downwards	Navigation downwards	Fast forward
	Press and Hold	Next page	Next page	/

Setting the general settings

- Press and hold down the **M** button to enter the main menu.
- Press the **Up / Down** button to select the **Settings** option.
- Briefly press the **M** button to enter the submenu.
- This menu item allows you to configure the following settings.

Settings







Date









Setting the system date

- In the **Settings** submenu, select the **Date** menu option with the **Up / Down** button.
- The date is in the format of **YY/MM/DD**.
- Briefly press the **M** button to active the **Date** submenu. Two triangle icons will appear above and below the value.
- Switch among the year, month, and day with a short press of the **M** button.



		<ul style="list-style-type: none"> ● Set the correct year, month, and day with a short press of the Up / Down button. ● Press and hold down the M button to save and exit.
<p style="text-align: center;">Time</p> 		<p>Setting the system time</p> <ul style="list-style-type: none"> ● In the Settings submenu, select the Time menu option with the Up / Down button. ● The time format is displayed as HH:MM in 24-hours format. ● Press the M button to activate the Date submenu. Two triangle icons will appear above and below the value. ● Select the correct value for the hour and minute with a short press of the Up / Down button. ● Short press the M button to switch between hour and minute. ● Press and hold down the M button to save and exit. And the time in the status bar changes accordingly. 
<p style="text-align: center;">Language</p> 		<p>Setting the system language</p> <ul style="list-style-type: none"> ● In the Settings submenu, select the Language menu option with the Up / Down button. ● Enter the Language submenu with a short press of the M button. ● Select the desired language with a short press of the Up / Down button. 

		<ul style="list-style-type: none"> ● Press the M button to confirm the selection. At the same time, it will save setting and exit to the Settings submenu automatically.
	<p style="text-align: center;">EIS</p> 	<p>Turn Electronic Image Stabilization on/off</p> <ul style="list-style-type: none"> ● In the Settings submenu, select the EIS menu option with the Up / Down button. ● Press the M button to turn EIS on/off ● When EIS is turned on, the image will be slightly enlarged. ● When the electronic zoom >1x, EIS is turned on by default. It is not affected by the function switch. 
	<p style="text-align: center;">Factory Reset</p> 	<p>Restoring factory default settings</p> <ul style="list-style-type: none"> ● In the Settings submenu, select the Factory Reset menu option with the Up / Down button. ● Press the M button to enter the Factory Reset submenu. ● Press the Up / Down button to select Yes or No. Yes means to restore factory settings and No means to cancel the operation. ● Confirm your selection with a short press of the M button. ● If Yes is selected, the thermal imaging monocular will reboot automatically. ● If No is selected, the operation is canceled and the screen returns to the upper menu. 

		<p>After the Factory Reset is selected, the following functions will be restored to default settings:</p> <ul style="list-style-type: none"> - Image mode: white hot - Display brightness: level 5 - Image sharpness: level 5 - Image contrast: level 5 - Digital zoom: 1× - Ultra-clear mode: off - Wi-Fi: off - Image Hue: C - MIC: off - Calibration mode: A
	<p>Info</p> 	<p>Showing the system information</p> <ul style="list-style-type: none"> ● In the Settings submenu, select the Info menu option with the Up / Down button. ● The relevant information of device will be shown by a short press of the M button. ● This item allows the user to view the following information of the current thermal imaging monocular: product model, Firmware, PN, SN, hardware version number, etc. ● Press and hold the M button to return to the General Settings submenu. 

13 Digital Zoom

The LUMI series supports quick digital zoom-in for images, to increase visual magnification.

- On the home screen, press the **Up button** to zoom the image.
- The corresponding magnification is displayed in the status bar.
- The following table lists the visual magnifications corresponding



MODEL	magnification				
	Zoom 1×	Zoom 2×	Zoom 3×	Zoom 4×	Zoom 8×
P13	2×	4×	6×	8×	
L19	2×	4×	6×	8×	
L35	4×	8×	12×	16×	
H35	2.5×	5×		10×	20×

14 Photographing and Video Recording

The LUMI series thermal imaging monocular is equipped with a built-in 32GB memory storage and supports photographing and video recording. The image and video files will be named after time, so it is recommended to set

the system date and time in the Main Menu before using the photo and video functions (refers to **Main Menu - Settings - Date/Time Setting** in this manual), or to synchronize the system date and time in the settings of the NOCPPIX App. For details, refer to the Operating Instructions for the App in our official website (www.nocpix.com).

Photographing

- On the home screen, press the **Down button** to take a photo. The image freezes for 0.5 sec with a camera icon  flash on the upper left corner. After the image is taken, the icon disappears.
- The images taken are saved in the built-in memory storage.
- When the exclamation mark icon  appears on the right side of the camera icon, it prompts that the memory space is insufficient. Check and transfer your videos and images to other media to free up the space.

Video Recording

- On the home screen, press and hold the **Down button** to start the video recording.
- The recording icon  and recording time prompt are displayed on the upper left corner of the display, and the time is in the format of HH: MM: SS (hour: Minute: Second).

- The red dot on the left of the time prompt will flash continuously when recording.
- During recording, you can also take a photo by pressing the **Down button**.
- Press and hold the **Down button** to stop and save the video. Recording.
- All videos and photos will be saved in the built-in memory storage.
- LUMI series is built-in Microphone function, You can turn on the microphone function to record while recording.

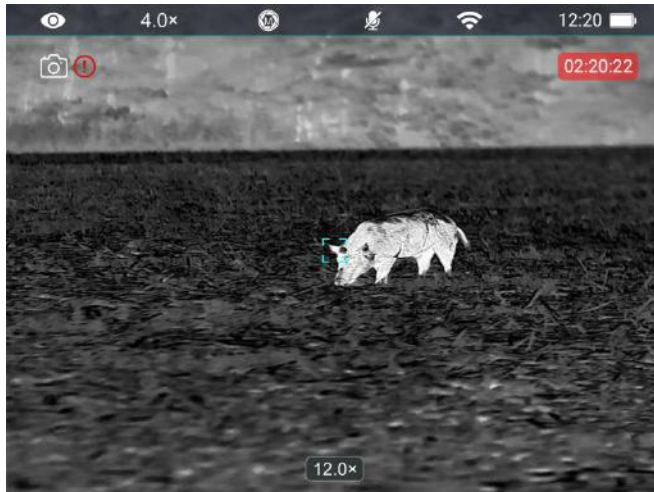

Note

- You can enter and work on the menu during video recording.
- The image taken and the recorded video will be respectively saved in the names in the formats of IMG_yyyyMMddHHmmss.jpg and VID_yyyyMMddHHmmss.mp4 in the built-in memory card (yyyyMMddHHmmss-year, month, date, hour, minute, and second);

- Due to the limitation of the storage space, it is recommended that you clean the memory regularly or move the images and videos to other storage medium to release memory space of the device.

Memory Access

When the device is powered on and connected to a computer, it will be recognized by the computer as a flash memory card. Then, you can access the memory of the device and copy images and videos.

- Connect the device to a computer through the data cable.
- Power on the device.
- Double-click "My Computer" on the desktop - double-click to open the device named "NOCPPIX"- then double-click to open the device name "LUMI" to access the memory.
- Files named by time will be displayed after you access the memory.

15 PIP Function

Picture-in-Picture (PIP) provides a floating window independent of the full screen. This window shows part of the image which is enlarged to 2x in a certain area centered on the reticle of the main image.

- On the home screen, press and hold the **Up button** to turn the PIP function on/off.

- When you press the **Up button** to enlarge the main image, the image in the PIP window will also be enlarged by 2 times accordingly. For example, if the main image is enlarged by 1×, 2×, 3×, or 4×, the image in the PIP window will be enlarged by 2×, 4×, 6×, or 8× respectively.



16 Technical Inspection

Perform a technical inspection to check the following items each time before you use the device:

- Exterior of the device (no crack on the enclosure).
- Lens and eyepiece (no crack, oil, stain, or other sediments)
- Status of the rechargeable battery (fully charged in advance) and electrical contact (no salinization or oxidation).

17 Maintenance

The maintenance should be carried out at least twice a year and includes the following steps:

- Wipe the surface of metal and plastic parts to clear off dust and dirt with a cotton cloth. Silicone grease may be used for cleaning process.
- Clean the electric contacts and battery slots on the device using a non-greasy organic solvent.
- Check the glass surface of the eyepiece and lens. If necessary, clear off the dust and sand on the lens (it is perfect to use a non-contact method). Use a specialized wiping tool and solvent to clean the optical surfaces.

18 Troubleshooting

The following table lists all problems that are likely to occur during device operation. Check and address problems by referring to this table. If faults not included in this table occur or you cannot fix the fault, return the device to the vendor or supplier for troubleshooting.

Faults	Possible Causes	Solutions
The device cannot start.	The battery is out of charge	Charge the battery
The device cannot be powered by an external power supply	The USB cable is damaged	Replace the USB cable
	The external power supply is insufficient	If necessary, check the external power supply
Images are too dark	The display is not bright enough	Adjust the display brightness
The image quality is poor or the detection range shortens	These problems are likely to occur when you use the device in harsh weather (such as snow, rain, and fog).	
The device cannot connect to a smartphone or computer	The Wi-Fi password is incorrect	Enter the correct password
	There are too many Wi-Fi networks in the range of the device, which may cause interference	To enable stable network access, you are advised to move the device to an area with a limited number of Wi-Fi networks, or an area without Wi-Fi coverage
Wi-Fi signals are lost or interrupted.	<p>The device is beyond Wi-Fi coverage.</p> <p>There is blocking (such as concrete walls) between the device and the receiver.</p>	Move the device to a place where you can receive Wi-Fi signals.
When the device is used at a low temperature, the imaging quality is poorer than that at normal temperature.	<p>At temperatures above 0°C, the temperature rise varies with the observed objects (environment and background) due to different heat conductivity coefficients. As a result, high-temperature contrast occurs and the image quality is better.</p> <p>At low temperatures, the observed targets (background) usually cool down to a similar temperature because of reduced temperature contrast. Therefore, the image quality (details in particular) is poor, which is a characteristic of thermal imaging devices.</p>	

19 Legal and Regulatory Information

Wireless transmitter module frequency range:

WLAN: 2.412-2.472GHz (for EU)

Wireless transmitter module power < 20dBm (only for EU)



We, Inlumen Technologies Co., Ltd. hereby declares that the radio equipment Lumi series is in compliance with the Directives 2014/53/EU and 2011/65/EU

FCC Statement

FCC ID: 2BHFB-LUMI-00

Labeling requirements

This device complies with part 15 of the FCC Rules. Operation is subject to the following two conditions: (1) This device may not cause harmful interference, and (2) this device must accept any interference received, including interference that may cause undesired operation.

Information to the user

Any Changes or modifications not expressly approved by the party responsible for compliance could void the user's authority to operate the equipment.

EMC: Class A

Note: This equipment has been tested and found to comply with the limits for a Class A digital device, pursuant to part 15 of the FCC Rules. These limits are designed to provide reasonable protection against harmful interference when the equipment is operated in a commercial environment. This equipment generates, uses, and can radiate radio frequency energy and, if not installed and used in accordance with the instruction manual, may cause harmful interference to radio communications. Operation of this equipment in a residential area is likely to cause harmful interference in which case the user will be required to correct the interference at his own expense.

To comply with RF exposure requirements, a minimum separation distance of 0.00 cm must be maintained between the user's body and the handset, including the antenna.



 **Manufacturer:** Inlumen Technologies Co., Ltd.

 **E-mail:** service@nocpix.com

 **Website:** www.nocpix.com

 **Add.:** North 6F, Building B3, Hefei Software Park, No.800 Wangjiang West Road, Hefei National High-tech Industry Development District, Anhui, China.