

SLIM

Thermal Imaging Scope



User Manual

SLIM L35 / SLIM H35

V1.0

IMPORTANT SAFETY INFORMATION

Environmental influences

- Never point the lens of the device directly at intense heat sources such as the sun or laser equipment. The objective lens and eyepiece can function as a burning glass and damage the interior components.
- Avoid touching the metal surface (cooling fins) after exposure to sunlight or cold.

Ergonomics notes

Take breaks after longer periods of use to avoid wrist pain.

Risk of swallowing

Do not place this device in the hands of small children. Incorrect handling can cause small parts to come loose which may be swallowed.

Safety instructions for use

- Handle the device with care: rough handling can damage the internal battery.
- Do not expose the device to fire or high temperatures.
- Install the batteries correctly according to the instruction on the device. Reverse connection is prohibited.
- The battery capacity decreases when operated in a cold ambient temperature. This is not a fault and occurs for technical reasons.
- The recommended temperature for using this product is -20° to +50°. Otherwise, it will affect the service life of the product.
- Do not store the device for long periods at temperatures below -20°C or above 50°C, or it will permanently reduce the battery capacity.
- Always store the device in a dry, well-ventilated space.
- If the device has been damaged or the battery is defective, send the device to our after-sales service for repair.

Safety instructions for the power supply unit

- Check the power supply unit, cable and adapter for visible damage before use.

- Do not use any defective parts. Defective components must be replaced.
- Do not use the power supply unit in wet or humid environments.
- Only charge the device at temperatures ranging between 0°C and 50°C.
- Do not make any technical modifications.

Disposal of batteries



2023/1542 (Battery Regulation): This product contains a battery that cannot be disposed of as unsorted municipal waste in the European Union. For battery details, refer to the documentation of the specific product. The battery is marked with this symbol, which may include Cd (indicating cadmium), Pb (indicating lead), or Hg (indicating mercury). For proper recycling, please return the battery to your supplier or send it to a designated collection point. For more information, visit www.recyclethis.info.

User information on the disposal of electrical and electronic devices (private households)



2012/19/EU (WEEE directive): Products marked with this symbol cannot be disposed of as unsorted municipal waste in the European Union. For proper recycling, return this product to your local supplier upon the purchase of equivalent new equipment, or dispose of it at designated collection points. For more information see: www.recyclethis.info.

For business customers within the European Union

Please contact your dealer or supplier regarding the disposal of electrical and electronic devices. He will provide you with further information.

Information on disposal in other countries outside of the European Union

This symbol is only applicable in the European Union. Please contact your local authority or dealer if you wish to dispose of this product and ask for a disposal option.

Intended use

The device is intended for displaying heat signatures during nature

observation, remote hunting observations and for civil use. This device is not a toy for children.

Use the device only as described in this operating manual. The manufacturer and the dealer accept no liability for damages which arise due to non-intended or incorrect use.

Function test

- Before use, please ensure that your device has no visible damage.
- Test to see if the device displays a clear, undisturbed image.
- Check that the settings for the thermal imaging monocular are correct.

Installing/Removing the battery

The SLIM Thermal Imaging Scope is equipped with one replaceable 18650 battery power supply system.

1 Specifications

Model	SLIM H35	SLIM L35
Detector Specifications		
Resolution, pixel	640 × 512	384 × 288
Pixel Size, μm	12	
NETD, mK	≤ 18	
Frame Rate, Hz	50	
Optical Specifications		
Objective Lens, mm	F35 /1.0	F35 /1.0
Field of View, °	12.5 × 9.4	7.5 × 5.7
Linear Field of View (H×V), m at 100m	21.9 × 16.5	13.2 × 9.9
Visual Magnification, ×	2 ~ 8	3.5 ~ 14
Eye Relief, mm	48	
Diopter Adjustment, D	-5 ~ +5	
Exit pupil Diameter, mm	10	
Detection Range, m (Target size:1.7m×0.5m), P(n)=99%	1800	

Display Specifications		
Type	AMOLED	
Resolution, pixels	1024 × 768	
Size, inch	0.39	
Power Supply		
Battery Type	Li-ion 18650	
Max Operating Time (t=22 °C), h*	4	5
Sevice Voltage, V	3 ~ 4.2	
External Power Supply, V	5 (Type C)	
Physical Specifications		
Wi-Fi / APP	Support (Nocpix)	
Photo / Video Recorder	Support	
Recoil activated video	Support	
MIC	Support	
IP Rating	IP67	
Memory Capacity, GB	32	
Operating Temperature, °C	-20 ~ +50	
Weight, g	≤ 530	

Dimension, mm	216 × 76 × 46
Body Material	Magnesium Alloy
Connections and Compatibilities	
Max. recoil power on rifled weapon (Eo), Joules	6000
Mount	Picatinny mount

- ★ The actual service time depends on the use frequency of functions like Wi-Fi, video recording, etc.
- Improvements may be made to the design and software of this product to enhance its features without prior notice.
- The newest user manual can be downloaded at our official website: www.nocpix.com.

2 Package Contents

- SLIM series thermal imaging scope
- Portable bag
- Picatinny rail
- 3mm Hex Key

- 18650 battery ×2
- 18650 battery charger with USB-C cable
- Magnetic Charging cable
- Heated target for zeroing
- Lens cloth
- Quick Start Guide

3 Introduction

The all-new SLIM series from NOCPIX provides the best value and features in a compact optic. These units can be used as both a handheld monocular and a weapon sight. A magnesium alloy body and quiet, soft-touch buttons provide excellent ergonomics in both handheld and weapon-mounted configurations. The included 18650 batteries ensure a longer time in the field, and the ability to charge through the optic using a magnetic cable keeps the process streamlined. Generous eye relief and a 1024×768 AMOLED display provide a comfortable and highly detailed viewing experience.

4 Features

- 12 um high-performance thermal detector
- ≤ 18mK sensitivity
- Digital zoom from 1.0x-4.0x
- Magnesium alloy housing
- Includes two rechargeable 18650 batteries
- Maximum detection range 1800m
- 1024x768 AMOLED display
- High frame frequency: 50Hz
- Multiple reticle types and color options
- Supports multiple charging options, including a durable magnetic charging cable
- Recoil activated video
- Multiple zero profiles and ranges
- Built-in 32 GB storage to support image capture and video recording
- Built-in Wi-Fi module
- Mobile device App compatible



- Picture in Picture (PIP)
- User-friendly interface
- Pixel calibration functions

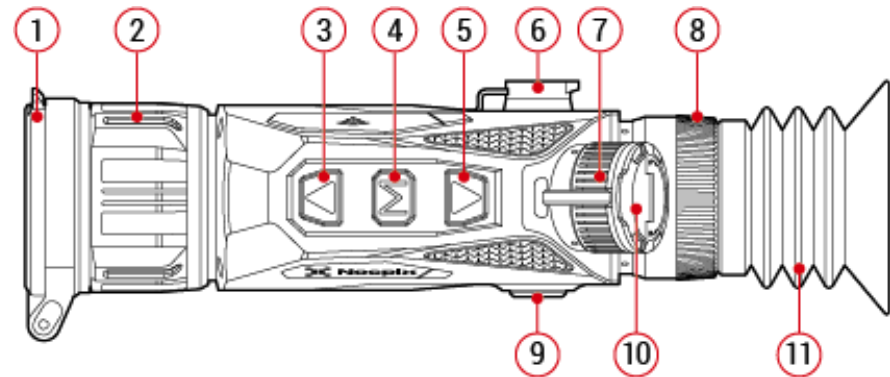

5 Components and Controls



- | | |
|---------------------------------------|---------------------------------|
| 1. Lens cap | 7. Battery cover |
| 2. Objective lens | 8. Diopter adjustment handwheel |
| 3. Up button / Zoom button | 9. Power button |
| 4. Menu button / M button | 10. Ring-pull |
| 5. Down button / Capture button | 11. Eyeshade |
| 6. Magnetic charge port / Type C port | |

6 Button Operation

Button	Current Status	Press	Long Press
	Powered off	--	Power on the device
	Home screen	Enter the standby mode	Power off the device
	Standby Mode	Wake up the device	--
	Main Menu	Return to the previous menu without saving changes	--
	Home screen	Adjust the digital zoom level	Turn PIP on/off
	Menu interface	Navigation upwards	--
	Defect pixel correction / Reticle zeroing interface	Move the cursor 1 pixel in the positive direction	Move the cursor 10 pixels in the positive direction
	Home screen	Enter the quick menu	Enter the main menu
	Main menu	Confirm selection	Save and return to the home screen
	Quick menu	Change parameters	Exit the quick menu
	Defect pixel correction interface	Select / deselect the axis of movement (X or Y)	Correct saved list of pixel(s) and return to previous
	Reticle zeroing interface	Select / deselect the axis of movement (X or Y)	Save the new reticle position

	Home screen	Take a photo	Start / Stop recording video
	Menu interface	Navigation downwards	---
	Defect pixel correction & reticle zeroing interfaces	Move the cursor 1 pixel in the negative direction	Move the cursor 10 pixels in the negative direction
 + 	Home screen	Shutter correction	Background correction

7 Power Supply

The SLIM rifle scope comes with two long-lasting rechargeable, low-temperature-resistant lithium-ion 18650 batteries. Fully charge the batteries before using the SLIM for the first time.

Charging With the Battery Charger

- Insert a 18650 battery (13) into the battery charger (14) following the polarity markings (A) inside the battery slot.
- Connect the USB-C cable (12) to the USB-C port (B) on the battery charger.
- Connect the standard USB end of the data cable to:

- The 5V–2A USB power adapter; **OR**
- Any standard USB 3.0 port on a laptop or computer.

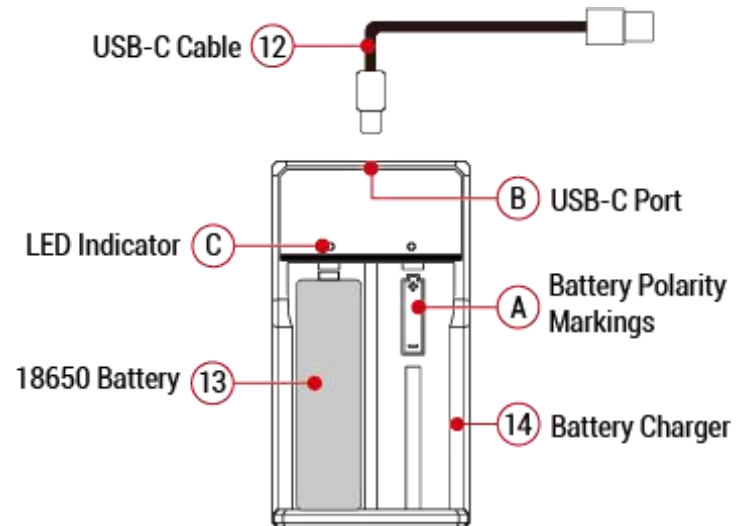

- During charging, the LED indicator (C) on the battery charger will be solid red.
- When the battery is fully charged, the LED indicator (C) will turn solid green. Remove the battery from the battery charger. Do not overcharge.

NOTE: When the LED indicator (C) flashes red, the battery charger (14) is connected to a power source but no battery is installed.

WARNING: Never use the battery charger with a USB power adapter that is greater than 5V–2A.

Charging Via the Magnetic Charging Port

- Place the magnetic charging cable on the magnetic port (6) on the side of the rifle scope.
- Connect the USB end of the magnetic charging cable to:
 - a. The 5V–2A USB power adapter; **OR**
 - b. Any standard USB 3.0 port on a laptop or computer; **OR**
 - c. An external power supply, such as a USB power bank.

Charging Via the USB-C Port

- Remove the magnetic charging port (6) and connect the USB-C cable (12) to the USB-C port behind it.
- Connect the standard USB end of the data cable to:
 - a. The 5V–2A USB power adapter; **OR**
 - b. Any standard USB 3.0 port on a laptop or computer; **OR**
 - c. An external power supply, such as a USB power bank.
- During charging, the battery status icon in the status bar changes to the battery charging icon ().
- When fully charged, disconnect the charging cable.

Safety Precautions

WARNING: Only use the factory-supplied battery charger. The use of any other charger may irreparably damage the battery or the charger and may cause a fire. Any damage from using an improper battery charger will not be covered by warranty.

WARNINGS:

- Do not use a battery charger, power adapter, or USB cable that has

been modified or damaged.

- Do not expose the batteries to high temperatures or open flame, and do not immerse it in water.
- Do not leave the batteries unattended while charging.
- Do not leave the batteries charging for long periods after full charge is reached. Charging time should not exceed 24 hours.
- Keep batteries out of the reach of children and pets.
- The batteries are equipped with short-circuit protection. However, any situation that may cause short-circuiting should be avoided.
- Do not disassemble, modify, hit, or drop the batteries.
- Do not connect the batteries to any external device with an electrical current that exceeds permitted levels.
- Do not connect an external device with a current supply that exceeds the 3.0 USB port.

To maintain optimal battery capacity and service life:

- Avoid storing a fully charged or discharged battery for long periods. Partial charging of the battery is necessary if the battery will be stored for an extended period.

- Do not charge an extremely cold battery. Allow the battery to warm up for about 45 minutes before charging.
- Charge the batteries at a temperature range from 0 °C to 45 °C; otherwise, the service life of the battery may be reduced.
- The recommended operating temperature range is -20 °C to 50 °C. Avoid using the batteries above the maximum or below the minimum recommended temperature range as this may decrease the battery capacity or service life.

8 Mounting the SLIM

Installing the Dual Throw Mount

Before using the SLIM, install the dual throw mount **(15)** to the two mounting holes in the base of the rifle scope.

- Install the dual throw mount **(15)** to the base of the SLIM using a 3mm hex key and the M5 screws **(16)** supplied in the package.
- Install the SLIM to the rifle and adjust its position so that it produces a clear image and is comfortable for the shooter.

- When the location is suitable, remove the M5 screws one at a time and apply a small amount of blue Loctite 242 to the threads.
- Reinsert each screw and tighten to 20 in/lbs with a torque wrench. Allow the threadlocker to dry.

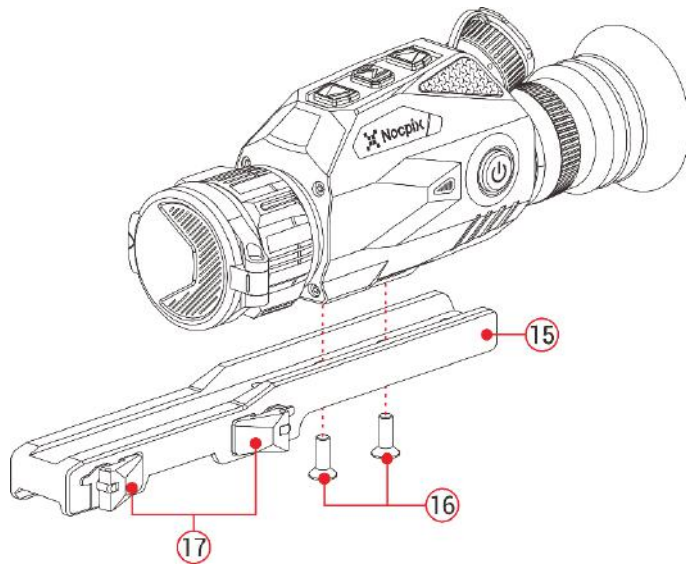

NOTE: Please note, torque is inch-pounds, NOT foot-pounds. If you do not have a torque wrench, apply until snug. Do not overtighten.

When the threadlocker is dry, install the mount and rifle scope to the Picatinny rail of your rifle.

- Press the locking button (18) and pull the locking lever (17) to open each throw lever.
- Install the mount to the Picatinny rail.
- Press the levers closed to lock the mount in place. You will hear the lever and locking button click.
- The SLIM is now ready to be zeroed. See Zeroing for instructions.

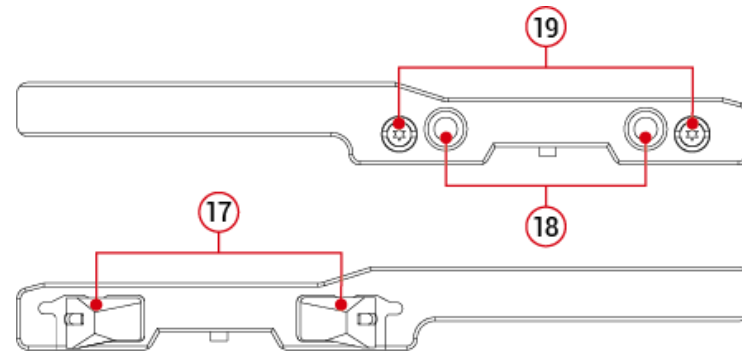

Adjusting the Throw Lever Tension

If you cannot slide the mount onto the Picatinny rail because the throw levers are in the open position but the locking plate is not, or if the mount is not tight to the rail after the throw levers are closed, you may loosen or tighten the tension of the throw levers by adjusting the nuts (19).

- Open both throw levers. This will cause the adjustment nuts (19) to protrude on the opposite side of the mount.
- Use the prong-side of the included spanner tool to turn the adjustment nut clockwise to tighten, or counterclockwise to loosen, to achieve the correct amount of tension. You should not feel any tension on the locking lever when closing until it reaches a 45-degree angle. Do not overtighten.

9 Start to Use

Using the Control Buttons

The SLIM is operated via four control buttons. The control buttons can be used to perform shortcut operations from the home screen, as well as in the menu and full-screen interfaces. See Description of Control Buttons and Shortcuts in “6 Button Operation” for shortcut button details.

Powering On

- Open the objective lens cap (1).

- Long press the **Power Button (9)** for 3seconds to turn on the rifle scope. The NOCPPIX logo will appear.
- To determine the current battery charge, check the battery status icon () in the status bar.



Powering Off

To power off the SLIM:

- Long press the **Power Button (9)**. The shutdown screen will open, showing a 3-second countdown.
- Continue holding the **Power Button (9)** until the countdown completes.
- “Data saving...” appears onscreen and the rifle scope will shut down after saving.

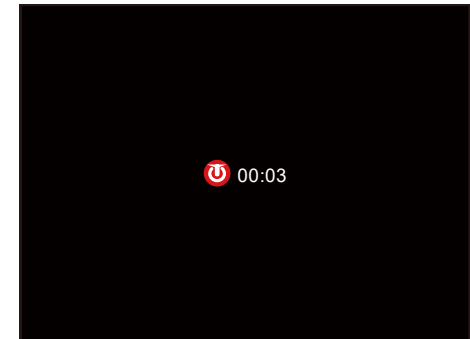

NOTE: Releasing the **Power Button (9)** at any time during the 3-second countdown will stop the shutdown process and the rifle scope will resume normal operation.

WARNING: If using an external power supply and no battery is installed, do not remove the power supply when saving data, as the data may not be saved.

Entering Standby

Manually Enter Standby Mode

- To enter standby at any time from the home screen, short press the **Power Button (9)**.
- Short press the **Power Button (9)** to exit standby.

Set the SLIM to Enter Standby Mode Automatically

The rifle scope may be set to automatically enter standby mode.

- In the main menu, set the standby time to 2, 4, or 6 minutes. Once set, the system will automatically enter standby according to the set time.
- Press any button to exit standby mode.

Auto Standby Notes:

- When 2min, 4min, or 6min is selected:
 - The motion sensor must be turned on for auto standby to work.
 - After the set number of minutes of inactivity, the rifle scope will enter standby mode automatically when it is tilted up or down at an angle of more than 70° or left or right at an angle of more than 30°.
 - The SLIM will not enter standby mode while it is in a level (horizontal) firing position.
- When off is selected, standby mode is turned off and the rifle scope will operate until the battery runs out.

Adjusting the Focus

ADJUSTING THE DIOPTER/EYEPIECE

- Rotate the eyepiece diopter adjustment ring **(8)** at the rear of the rifle scope right or left until the user interface is clear.
- Look closely to ensure all icons, the status bar, and the reticle appear sharp and in focus. No additional diopter adjustments are required unless the user wishes to make changes.

NOTES:

- After the initial adjustment, there is no need to rotate the eyepiece adjustment ring **(8)** for long distances or other conditions.
- If necessary during standard use, the objective lens focus knob **(2)** may be rotated to adjust fine focus on the target object being observed. See **Focusing the Objective Lens** below.

FOCUSING THE OBJECTIVE LENS

To adjust the focus on the target object:

- Rotate the objective lens focus knob **(2)** left or right to adjust fine focus.

NOTE: Re-adjusting the focus will be necessary if the distance to the target changes.















Activating / Deactivating the Reticle

The reticle may be inactive when the SLIM is powered on for the first time. To activate the reticle, press and hold the **Menu (4) and Down (5) Buttons** at the same time for 15 seconds from the home screen.

10 Status Bar

The status bar at the top of the screen shows information on the operating status of the SLIM.



- 1 Color Palette:** Shows the set color palette: white hot , black hot , red hot , pseudo-color , violet , crimson , or viridian .
- 2 Zeroing Profile & Distance:** Shows the selected zero profile, A, B, C, D, E, or F, and zero distance.
- 3 Total Magnification:** Shows the total magnification.
- 4 Ultra-Clear Mode:** Shows the Ultra-Clear status, on  or off .
- 5 Automatic Non-Uniformity Correction (NUC) Mode:** The automatic non-uniformity correction (NUC) mode  icon appears when turned on. A countdown  icon will appear instead of the auto NUC mode icon when 5 seconds remain until an automatic NUC.
- 6 Wi-Fi:** Shows the Wi-Fi status, on  or off .
- 7 Standby:** Shows standby  icon and status, 2min, 4min, 6min, or





off

8 Time: Shows the current time in 24-hour format.

9 Battery Status: Shows the battery status.

BATTERY STATUS

The battery icon color and fill level indicate the current battery status. The battery icon is replaced by the charging battery icon when an external power supply is connected.

COLOR / ICON	BATTERY STATUS
Green Battery 	41% - 100%
Yellow Battery 	20% - 40%
Red Battery 	<20%; charge the battery right away
Charging Battery 	The battery is charging; an external power supply or computer is connected via the charging cable.
USB 	No battery is installed; an external power supply or computer is connected via the charging cable.

11 Zeroing

SLIM features a “freeze” zeroing method. To zero the SLIM:

1. Set a suitable target at the desired zero distance.
2. Confirm that the rifle is empty, safe, and pointed in a safe direction, with no ammunition near the weapon.
3. Adjust the image and device settings following the steps in the **Getting Started**, if you have not done so already
4. Set the zeroing profile to A, B, C, D, E, or F.
5. Based on the distance to the target you wish to zero, select or customize a zero distance to match.
6. Ensure a stable platform and natural shooting position is achieved behind the rifle.
7. Load ammunition, aim, and take one good shot at the target.
8. Make your rifle safe and observe the location of impact on the target.
9. If the point of impact does not match the point of aim (the center of the reticle), adjust the X/Y position of the reticle.

10. In the submenu for the selected zero distance, center the reticle on the aiming point and freeze the image view.
 - a. Short press the **Down Button (5)** to move to the image freeze icon.
 - b. Short press the **Menu Button (4)** to freeze the image.
11. Select the axis (X or Y) along which to move the reticle.
 - a. Short press the **Up (3) or Down (5) Button** to move between X and Y.
 - b. Short press the **Menu Button (4)** to select the desired axis. The selected axis will change from white to blue.
12. Adjust the X/Y position of the reticle until the reticle matches the point of impact.
 - a. Use the **Up Button (3)** to move in the positive direction: X= Right and Y= Up.
 - b. Use the **Down Button (5)** to move in the negative direction: X= Left and Y= Down.
 - c. Upon moving the reticle, a red dot appears on the screen, representing the original position of the reticle.
13. Long press the **Menu Button (4)** to save the reticle position.

14. Take a confirmation shot—the point of impact should now match the point of aim. If not, adjust the X/Y position of the reticle again.

12 Calibration

A non-uniformity correction (NUC) allows a thermal imager's sensors to correct its pixels and eliminate any image defects caused by pixel drift. A NUC will be performed automatically each time the SLIM is powered on.

Automatic NUC Mode

When automatic NUC mode  is turned on in the main menu, the SLIM will perform a shuttered NUC automatically according to the internal software algorithm. There is no need to close the objective lens cap (1) as the SLIM's internal shutter covers the sensor. When automatic mode is turned on, a countdown timer icon will appear when 5 seconds remain until a NUC. The timer will appear only after the microbolometer temperature has stabilized—after approximately 10 minutes of continuous operation of the SLIM.

NOTE: A manual NUC (see below) may be performed at any time.

Performing a Manual NUC

The user independently determines the need to perform a shuttered or shutterless NUC based on the quality of the observed image. A manual NUC may be performed at any time from the home screen.

SHUTTERED NUC

It is not necessary to close the objective lens cap (1) during a shuttered NUC, as the internal shutter covers the sensor.

- From the home screen, short press the **Up (3) and Down (5) Buttons** at the same time.
- The internal shutter will cover the sensor and a shuttered non-uniformity correction (NUC) will be performed instantly.

SHUTTERLESS NUC

A shutterless NUC uses less power than a shuttered NUC because it does not use the imager shutter to cover the sensor; instead, the user must close the lens cap.

- Close the objective lens cap (1).

- From the home screen, long press the **Up (3) and Down (5) Buttons** at the same time.
- A prompt to close the lens cap appears onscreen. The shutterless NUC starts after about 2 seconds.

NOTE: If the lens is not properly covered, a temporary “image burn” will remain in the image until the next non-uniformity correction. This “image burn” is temporary and is not a defect or sign of permanent damage.

13 Digital Zoom

The SLIM will quickly increase the base magnification by enlarging the image from 1 to 4 times digitally.

To use digital zoom:

- From the home screen, short press the Up Button to toggle through the digital zoom levels, 1×, 2×, 3×, to 4×.
- The total magnification is displayed in the status bar. The following table lists the real-time amplification corresponding to each digital

zoom level.

MODEL	BASE MAGNIFICATION	DIGITAL ZOOM MAGNIFICATIONS			
		1×	2×	3×	4×
SLIM L35	3.5×	3.5	7	10.5	14
SLIM H35	2×	2	4	6	8

14 Photographing / Video Recording

The SLIM is equipped with video recording and image capture. All videos and photos are automatically saved to the built-in 32 GB memory storage.

NOTE: Photo and video files are named with the time and date; therefore, it is recommended to set the date and time before using the photo and video functions.

Photographing

To take a photo:

- From the home screen, short press the **Down Button (5)**.
- The image will freeze for 0.5 seconds and the camera icon  will

appear briefly in the upper-left corner of the screen to indicate a photo was taken.

NOTE: A red warning icon 

appears next to the camera icon in the upper-left corner of the screen when insufficient memory storage is available. Transfer video and image files to other storage media to free up space on the memory card.



Video Recording

To record video:

- Turn on the microphone in the main menu if desired.
- From the home screen, long press the **Down Button (5)** to start a video recording.
- When the video recording starts, the recording timer, in HH:MM:SS (hour, minute, second) format, appears in the upper-right corner of the screen.



- When recording, short press the **Down Button (5)** to take a photo.
- Long press the Down Button to stop and save the video recording.

Recoil Activated Video Recording

When recoil activated video is turned on in the main menu, a video is automatically recorded when a shot is taken. The SLIM will record 15 seconds before the shot and 2 minutes and 45 seconds after the shot. The video recording timer, in HH:MM:SS (hour, minute, second) format, will appear in the upper-right corner of the screen when video is recording.

NOTES:

- When multiple shots are taken within the same 30-second period, only one video will be taken.
- When recoil activated video recording is turned on, standard video recording is unavailable.

Video and Photography Notes

- You may enter and navigate the menu during video recording.

- The user interface (the status bar, icons, and menu) is captured in recorded video or photo files.
- Recorded photos and videos are saved to the memory card.
 - Photos are saved as PIC_HHMMSS.jpg.
 - Videos are saved as HHMMSS.mp4.
 - RAV videos are saved as PRE_HHMMSS.mp4.
 - HHMMSS is hour, minute, second.
- The number of recorded files is limited only by the capacity of the internal memory.
- Regularly check the available memory storage space and move video footage and images to other storage media to free up space on the memory card.

Accessing the internal Memory

When the SLIM is turned on and connected to a computer via the included data cable, it is recognized by the computer as a flash memory (USB) drive. This allows the user to access the saved multimedia files and copy or delete any desired files.

To access the internal memory:

- Turn on the SLIM.
- Connect the SLIM to your computer via the included magnetic charging cable or the USB-C cable.
- Double-click **My Computer** on your computer desktop.
- Double-click to open the device named **NOCPIX**.
- Double-click to open the device named **SLIM** to access the built-in memory.
 - Recorded photos and videos are separated into folders by date, YYYYDDMM.
- Select the desired files or folders to copy or delete.

15 PIP Function

The Picture in Picture (PIP) function opens a small floating window with a magnified image view at the top of the screen. PIP allows for improved aiming while still being able to see the wide field of view in the main body of the screen.



To activate PIP mode:

- From the home screen, long press the **Up Button (3)**. A 2× zoomed image, centered on the reticle, will appear at the top of the screen. Please note that the PIP image is 2× that of the total magnification shown in the status bar.
- To exit PIP mode, long press the **Up Button (3)** again.

NOTE: When the image in the main body of the screen is magnified via digital zoom, the PIP image will enlarge accordingly.







16 Shortcut Menu

In the quick menu, the color palette, image brightness, image contrast, image sharpness, and zero distance can be quickly adjusted.

- On the home screen, short press the **Menu Button (4)** to enter the quick menu.
- Short press the **Up (3) or Down (5) Button** to move between the



menu options below. The selected menu item is highlighted in the background.

- **Color Palette** (🎨): Short press the **Menu Button (4)** to set the color palette to white hot , black hot , red hot , rainbow , violet , crimson , or viridian .
 - **Image Brightness** (☀): Short press the **Menu Button (4)** to set the image brightness level, from 1–10.
 - **Image Contrast** (◐): Short press the **Menu Button (4)** to set the image contrast level, from 1–10.
 - **Image sharpness** (▲▲): Short press the **Menu Button (4)** to set the image sharpness level, from 1–10.
 - **Zeroing Distance** (📏): Short press the **Menu Button (4)** to select a zero distance within the selected zeroing profile. Only the zero distances in the selected profile will be available for selection. The selected zeroing profile and distance appear in the status bar.
- Long press the **Menu Button (4)** to save any changes and return to the home screen.
 - After 5 seconds of inactivity, the system will automatically save any

changes and return to the home screen.

17 Main Menu

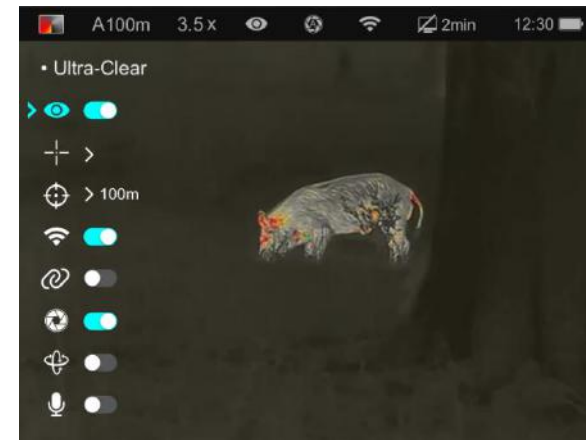



- From the home screen, long press the **Menu Button (4)** to enter the main menu.
- Short press the **Up (3) or Down (5) Button** to move through the menu options.
- A blue arrow icon indicates the cursor position in the menu.
- Short press the **Menu Button (4)** to:
 - Change the parameters for the selected menu option; **OR**
 - Enter the submenu; **OR**







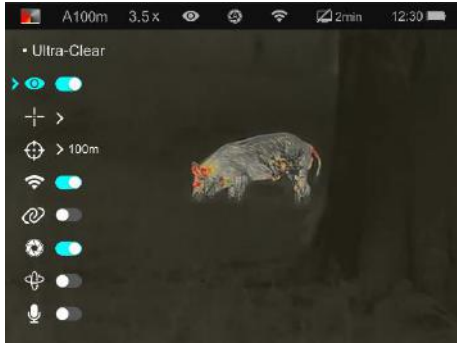

- Confirm submenu changes and return to the previous menu.
- Long press the **Menu Button (4)** to confirm any changes and return to the home screen.
- Short press the **Power Button (9)** to return to the previous menu without saving.
- After 15 seconds of inactivity, the menu will automatically close and the interface will return to the home screen. Changes (except





changes to toggle on / off menu items, such as Ultra-Clear and Wi-Fi) are not saved automatically.

- Upon exiting from the main menu, the cursor location is stored for a single working session (until the SLIM is turned off). After restarting the SLIM and entering the menu, the cursor position will be at the first menu item.

Main Menu Features and Descriptions

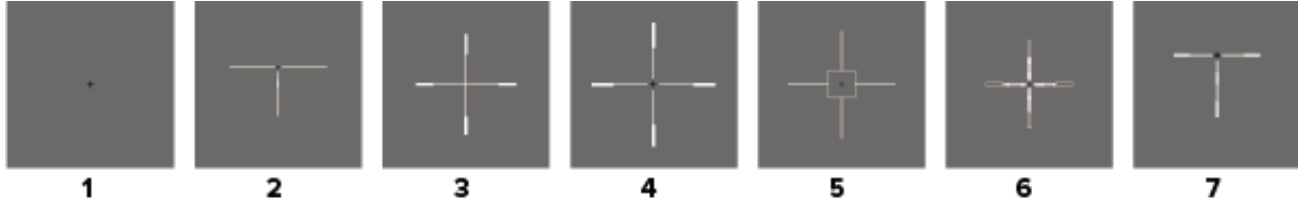
<p>Ultra-Clear Mode</p> 	<p>Turn on/off the Ultra-Clear Mode</p> <p>When Ultra-Clear mode is turned on, the image contrast is enhanced, which is suitable for rainy, foggy, or low-contrast conditions.</p> <ul style="list-style-type: none"> ● Long press the Menu Button (4) to enter the main menu. ● Short press the Up (3) or Down (5) Button to select the Ultra-Clear  menu item. ● Short press the Menu Button (4) to turn Ultra-Clear on / off. ● The Ultra-Clear status, on or off, appears in the status bar. ● Long press the Menu Button (4) to return to the home screen. <p>NOTE: When Ultra-Clear mode is turned on and off, the SLIM will automatically perform a shuttered non-uniformity correction.</p>	
---	--	--

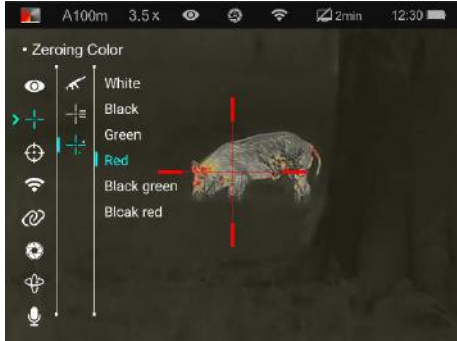
	<p>Select the zeroing profile, reticle type, and reticle color</p> <ul style="list-style-type: none"> ● Long press the Menu Button (4) to enter the main menu. ● Short press the Up (3) or Down (5) Button to select the reticle menu item. ● Short press the Menu Button (4) to enter the reticle submenu 		
<p>Reticle</p> 	<p>Zeroing Profile</p> 	<p>Selecting the zeroing profile</p> <ul style="list-style-type: none"> ● In the reticle submenu, the zeroing profile  menu item is selected by default. ● Short press the Menu Button (4) to enter the zeroing profile submenu. ● Short press the Up (3) or Down (5) Button to move through zeroing profile options, A, B, C, D, E, or F. The selected zeroing profile appears in the status bar. ● Long press the Menu Button (4) to confirm the selection and return to the home screen. 	
	<p>Reticle Type</p> 	<p>Select the reticle type</p> <ul style="list-style-type: none"> ● In the reticle submenu, short press the Up (3) or Down (5) Button to select the reticle type  menu item. ● Short press the Menu Button (4) to enter the submenu. ● Short press the b to move through reticle type options, 1–7 (see below). The reticle changes as the cursor moves through the 	

		<p>reticle types. A custom reticle is also available for purchase in the NOCPIX App.</p> <ul style="list-style-type: none"> ● Long press the Menu Button (4) to confirm the selection and return to the home screen. <p>RETICLE TYPES</p> 
<p>Reticle Color</p> 		<p>Select the reticle color</p> <ul style="list-style-type: none"> ● In the reticle submenu, short press the Up (3) or Down (5) Button to select the reticle color  menu item. ● Short press the Menu Button (4) to enter the submenu. ● Short press the Up (3) or Down (5) Button to move through reticle color options, black red, black green, white red, white green, black white, white black, crimson, or viridian. The reticle color changes as the cursor moves through the color options. ● Long press the Menu Button (4) to confirm the selection and return to the home screen. 
<p>Zeroing</p> 		<p>Select or customize a zero distance</p> <p>In the zeroing menu, you can add a new zero distance or select a zero distance in the list to edit it, delete it, or adjust the reticle position. The SLIM supports up to 10 zero distances of 1 to 999 yards or 1 to 999 meters.</p> <p>NOTE: Before selecting or adding a new zero distance, you must select a zeroing profile, A, B, C, D, E, or F.</p>

- Long press the **Menu Button (4)** to enter the main menu.
- Short press the **Up (3) or Down (5) Button** to select the zeroing  menu item.
- Short press the **Menu Button (4)** to enter the zeroing submenu.

Zeroing Distance Submenu

Add or select a zero distance







To add a new zero distance:





- In the zeroing menu, short press the **Up (3) or Down (5) Button** to move to the add  icon.
- Short press the **Menu Button (4)** to add a new zero distance. A blue arrow will appear above and below the far-left digit of the new zero distance to mark the cursor location.
- Short press the **Up (3) or Down (5) Button** to increase or decrease the value of the selected digit from 0–9.
- Short press the **Menu Button (4)** to switch between the three digits. The two blue arrows move to indicate the selected digit.
- Short press the Power Button to return to the previous menu without saving changes; **OR**
- Long press the **Menu Button (4)** to save the new zero distance and return to the home screen.

To select a zero distance:

- In the zeroing menu, short press the **Up (3) or Down (5) Button** to select a zero distance.



	<ul style="list-style-type: none"> ● Short press the Menu Button (4) to enter the submenu for the selected zero distance. In this submenu, you may: <ol style="list-style-type: none"> Select the reticle zeroing  menu item to adjust the X/Y position of the reticle at the selected zero distance. See Reticle Zeroing below. Select the zero distance to edit it. See Zeroing Menu > Customize Zero Distance. Select the delete icon  to delete the selected zero distance. See Zeroing Menu > Delete Distance.
<p style="text-align: center;">Reticle Zeroing</p> 	<p>Adjust the reticle position of the selected zero distance</p> <p>In the reticle zeroing interface, the X/Y position of the reticle may be adjusted to match the point of impact.</p> <ul style="list-style-type: none"> ● In the submenu for the selected zero distance, the reticle zeroing  menu item is selected by default. Short press the Menu Button (4) to select it and enter the reticle zeroing interface. ● The reticle zeroing interface has the following features: <ul style="list-style-type: none"> - Y-Axis  Icon: Select to move the reticle along the Y-Axis. Shows the vertical point of impact change, in inches or centimeters. - X-Axis  Icon: Select to move the reticle along the X-Axis. Shows the horizontal point of impact change, in inches or centimeters. 

- **Zoom Icon**  : Select to change the zoom level.
- **Freeze Icon**  : Select to freeze the image.
- **Reticle:** Shows the new reticle position.
- **Red Dot:** Indicates the center of the original reticle position.
- In the submenu for the selected zero distance, center the reticle on the aiming point and freeze the image view.
 - a. Short press the **Down Button (5)** to move to the image freeze  icon.
 - b. Short press the **Menu Button (4)** to freeze the image.
- Adjust the zoom level, as needed:
 - a. Short press the **Up (3) or Down (5) Button** to move to the zoom  icon.
 - b. Short press the **Menu Button (4)** to select it.
 - c. Short press the **Up (3) or Down (5) Button** to zoom in or out. The real-time amplification appears in the status bar.
- Select the axis (X or Y) along which to move the reticle:
 - a. Short press the **Up (3) or Down (5) Button** to move between X and Y.
 - b. Short press the **Menu Button (4)** to select the desired axis. The selected axis will change from white to blue.
- Adjust the X/Y position of the reticle until the reticle matches the point of impact.
 - a. **X** (horizontal) is the windage and **Y** (vertical) is the elevation.









- b. Upon moving the reticle, a red dot appears onscreen, representing the original position of the reticle.
- c. Use the **Up Button (3)** to move in the positive direction: X= Right and Y= Up.
- d. Use the **Down Button (5)** to move in the negative direction: X= Left and Y= Down.
- e. Short press the **Up (3) or Down (5) Button** to move the reticle in the corresponding direction by 1 pixel; long press to move 10 pixels.
- f. The reticle position is adjusted as follows:

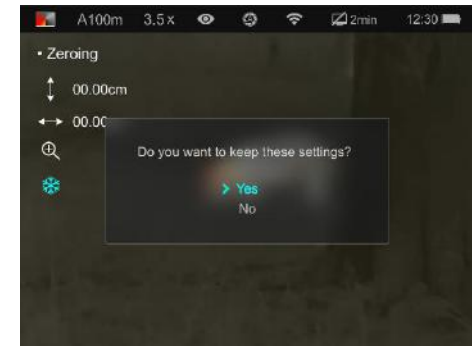





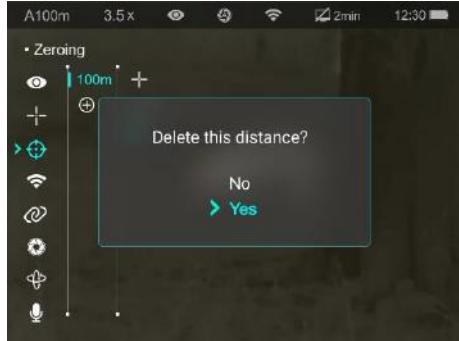

MODEL	DISTANCE (m)	SHORT PRESS (cm)	LONG PRESS (cm)
SLIM H35	50	1.07	10.71
	100	2.14	21.43
	200	4.29	42.86
SLIM L35	50	0.64	6.43
	100	1.29	12.86
	200	2.57	25.71



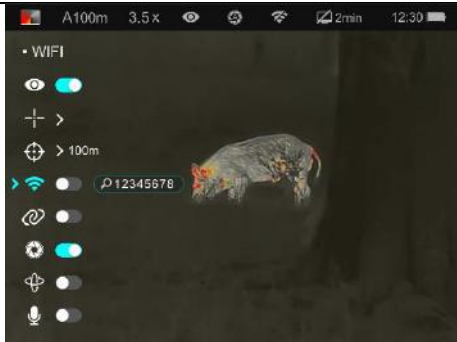

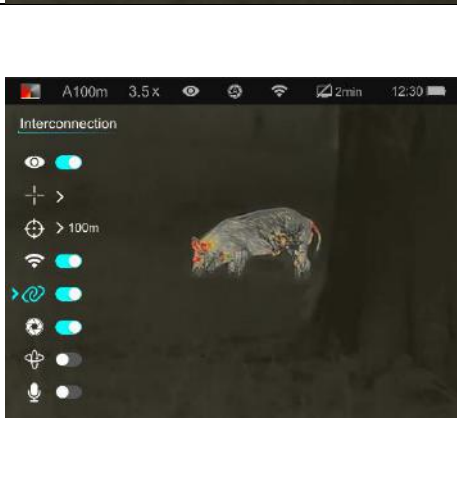

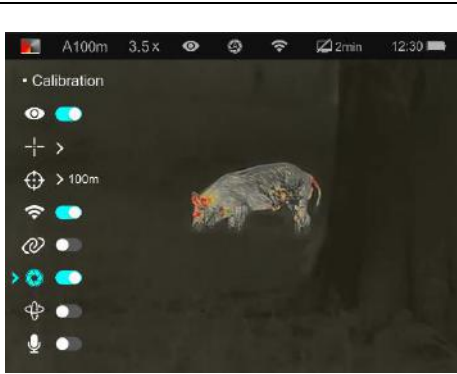

- g. The distance of your X/Y adjustments will update automatically if you change your zero distance, for example from 100 to 200 m.
- Short press the **Menu Button (4)** to save the position for the selected axis and deselect it. When deselected, the axis will change from blue to white.
- Repeat steps 5–7 to adjust the reticle position along the second axis if needed.

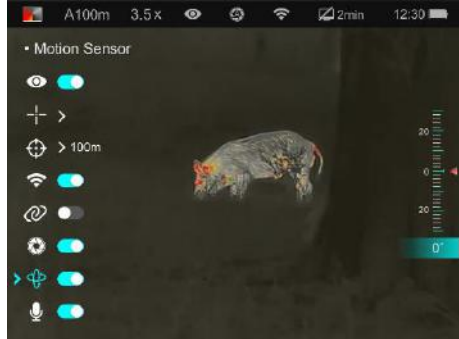

	<ul style="list-style-type: none"> ● Long press the Menu Button (4). A popup window shows “Save changes?” and two options, No and Yes. No is selected by default. ● Short press the Menu Button (4) to select No to return to the main menu without correcting any defective pixels; OR ● Short press the Up (3) or Down (5) Button to select Yes to correct the list of defective pixels and return to the home screen. ● “Saving” will appear at the bottom of the screen and the system will exit to the homepage. ● Take a confirmation shot—the point of impact should now match the point of aim. If not, adjust the X/Y position of the reticle again.
<p>Customize Zero Distance</p> <p>▼ 000 ▲</p>	<p>Edit the selected zero distance</p> <ul style="list-style-type: none"> ● In the submenu for the selected zero distance, short press the Up (3) or Down (5) Button to move to the zero distance. ● Short press the Menu Button (4) to edit the selected zero distance. A blue arrow will appear above and below the far-left digit to mark the cursor location. ● Short press the Up (3) or Down (5) Button to increase or decrease the value of the selected digit from 0–9. ● Short press the Menu Button (4) to switch between the three digits. The two blue arrows move to













		<p>indicate the selected digit.</p> <ul style="list-style-type: none"> ● Short press the Power Button (9) to return to the previous menu without saving changes; OR ● Long press the Menu Button (4) to save the edited zero distance and return to the previous menu.
	<p>Delete Distance</p> 	<p>Delete the selected zero distance</p> <ul style="list-style-type: none"> ● In the submenu for the selected zero distance, short press the Up (3) or Down (5) Button to move to the delete icon  . ● Short press the Menu Button (4) to delete the selected distance. ● A popup window shows the message “Delete this distance?” and two options, No and Yes. No is selected by default. ● Short press the Menu Button (4) to select No to return to the previous menu without deleting the zero distance; OR ● Short press the Up (3) or Down (5) Button to select Yes and short press the Menu Button (4) to delete the zero distance and return to the previous menu. <div data-bbox="1592 389 2049 730">  </div> <div data-bbox="1592 751 2049 1093">  </div>
<p>Wi-Fi</p> 	<p>Turn Wi-Fi on/off</p> <p>Turn on Wi-Fi to operate the SLIM via the NOCPIX App.</p>	<ul style="list-style-type: none"> ● Long press the Menu Button (4) to enter the main menu. ● Short press the Up (3) or Down (5) Button to select the Wi-Fi  menu item.

	<ul style="list-style-type: none"> ● Short press the Menu Button (4) to toggle Wi-Fi on / off. The Wi-Fi status, on  or off  , appears in the status bar. ● Long press the Menu Button (4) to return to the home screen 	
<p>Interconnection</p> 	<p>Turn interconnection feature on / off</p> <p>Use your smartphone or tablet as a hotspot to connect the SLIM to the NOCPIX App (instead of Wi-Fi).</p> <ul style="list-style-type: none"> ● Long press the Menu Button (4) to enter the main menu. ● Short press the Up (3) or Down (5) Button to select the interconnection  menu item. ● Short press the Menu Button (4) to toggle interconnection on / off. ● Long press the Menu Button (4) to return to the home screen. 	
<p>Calibration</p> 	<p>Turn automatic non-uniformity correction mode on / off</p> <ul style="list-style-type: none"> ● Long press the Menu Button (4) to enter the main menu. Short press the Up (3) or Down (5) Button to select the calibration  menu item. ● Short press the Menu Button (4) to toggle automatic non-uniformity correction (NUC) mode on / off. When on, the automatic NUC mode  icon appears in the status bar. ● Long press the Menu Button (4) to return to the home screen. 	

<p>Motion Sensor</p> 	<p>Turn the motion sensor on / off</p> <ul style="list-style-type: none"> ● Long press the Menu Button (4) to enter the main menu. ● Short press the Up (3) or Down (5) Button to select the motion sensor  menu item. ● Short press the Menu Button (4) to toggle the motion sensor on / off. When on, the tilt angle appears on the left side of the screen and the pitch angle appears on the right side of the screen. ● Long press the Menu Button (4) to return to the home screen. <p>NOTE: The tilt angle is not shown in the figure because it is hidden by the menu.</p>	
<p>MIC</p> 	<p>Turn the microphone on / off</p> <ul style="list-style-type: none"> ● Long press the Menu Button (4) to enter the main menu. ● Short press the Up (3) or Down (5) Button to select the MIC  menu item. ● Short press the Menu Button (4) to turn the microphone on / off. When on, the microphone icon appears in the lower-right corner of the screen. ● Long press the Menu Button (4) to return to the home screen 	
<p>Recoil Activated Video</p> 	<p>Turn recoil activated video on / off</p> <p>When recoil activated video is turned on, the rifle scope will record 15 seconds before the shot and 2 minutes and 45 seconds after the shot.</p> <ul style="list-style-type: none"> ● Long press the Menu Button (4) to enter the main menu. ● Short press the Up (3) or Down (5) Button to select the recoil activated video  	

	<p>menu item.</p> <ul style="list-style-type: none"> ● Short press the Menu Button (4) to toggle recoil activated video on / off. ● Long press the Menu Button (4) to confirm the selection and return to the home screen. <p>NOTES:</p> <ul style="list-style-type: none"> - The video recording timer, in HH:MM:SS (hour, minute, second) format, will appear in the upper-right corner of the screen when video is recording. - When multiple shots are taken within the same 30-second period, only one video will be taken. - When recoil activated video recording is turned on, standard video recording is unavailable.
<p>Image Hue</p> 	<p>Toggle between warm and cool image hue modes</p> <ul style="list-style-type: none"> ● Long press the Menu Button (4) to enter the main menu. ● Short press the Up (3) or Down (5) Button to select the image hue  menu item. ● Short press the Menu Button (4) to toggle between warm mode (toggle is on) and cool mode (toggle is off). ● Long press the Menu Button (4) to return to the home screen. <p>NOTES:</p> <ul style="list-style-type: none"> - Cool mode provides a brighter image and warm mode provides a softer image and reduces eye strain. - Image hue is available when using the white hot or black hot color palette. <div data-bbox="1592 699 2047 1388">  </div>







<p>Standby Settings</p> 	<p>Set the automatic standby status and time</p> <p>To conserve battery, the rifle scope may be set to automatically enter standby mode.</p> <ul style="list-style-type: none"> ● Long press the Menu Button (4) to enter the main menu. ● Short press the Up (3) or Down (5) Button to select the standby  menu item. ● Short press the Menu Button (4) to enter the standby submenu. ● Short press the Up (3) or Down (5) Button to move through the standby status options, 2min, 4min, 6min, or off. The standby  icon and status appear in the status bar. ● Long press the Menu Button (4) to confirm the selection and return to the home screen. <p>NOTES:</p> <ul style="list-style-type: none"> - When 2min, 4min, or 6min is selected: <ul style="list-style-type: none"> • The motion sensor must be turned on for automatic standby to work. • After the set number of minutes of inactivity, the rifle scope will enter standby mode automatically when it is tilted up or down at an angle of more than 70° or left or right at an angle of more than 30°. • The SLIM will not enter standby mode while it is in a level (horizontal) firing position. - When off is selected, standby mode is turned off and the rifle scope will operate until the battery runs out. 	
<p>Pixel Defect Correction</p> 	<p>Correct defective pixels</p> <p>Defective pixels are pixels that do not change correctly compared to the other image pixels—they are either brighter or darker than surrounding pixels. The SLIM has a tool that corrects defective pixels on the sensor using its internal software.</p> <ul style="list-style-type: none"> ● Long press the Menu Button (4) to enter the main menu. 	

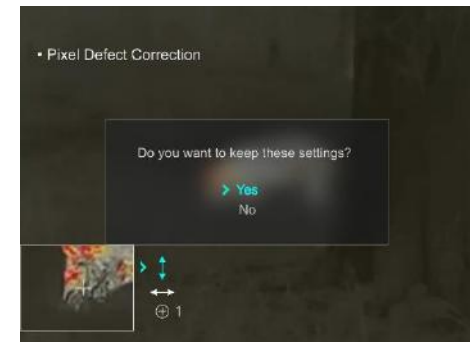

- Short press the **Up (3) or Down (5) Button** to select the pixel defect correction  menu item.
- Short press the **Menu Button (4)** to enter the pixel correction interface.
- The interface has the following features:
 - **Pixel Cursor ** : Appears in the center of the screen in place of the reticle. Move the cursor to the position of the defective pixel.
 - **PIP Window:** Appears in the lower-left corner.
 - **Y-Axis  Icon:** Select to move the pixel cursor vertically.
 - **X-Axis  Icon:** Select to move the pixel cursor horizontally.
 - **Add  Icon:** Select to add a defective pixel to the “to be corrected” list. The number of pixels in the list is shown to the right of the icon.
- Select the axis (X or Y) along which to move the cursor:
 - a. Short press the **Up (3) or Down (5) Button** to move between X and Y. The cursor position is indicated by a blue arrow  icon.
 - b. Short press the **Menu Button (4)** to select X or Y. The selected axis will change from white to blue.
- Move the cursor along the selected axis to the location of the defective pixel:
 - a. Use the **Up Button (3)** to move in the positive direction: X= Right and Y= Up.
 - b. Use the **Down Button (5)** to move in the negative direction: X= Left and Y= Down.
 - c. Short press the **Up (3) or Down (5) Button** to move the cursor in the corresponding direction by 1 pixel; long press to move 10 pixels.

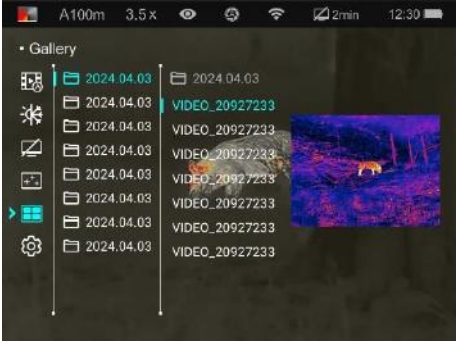







- Short press the **Menu Button (4)** to save the position for the selected axis and deselect it. When deselected, the axis will change from blue to white.
- Move to and select the second axis and adjust the cursor position, as needed.
- Add the pixel to the “to be corrected” list:
 - a. With the cursor in position, short press the **Menu Button (4)** to deselect the axis of movement.
 - b. Press the **Up (3) or Down (5) Button** to move to the add icon.
 - c. Short press the **Menu Button (4)** to add the pixel. The number of pixels to the right of the add icon will increase to indicate that one pixel has been added to the list.
 - d. If the defective pixel has been added in error, short press the **Menu Button (4)** a second time from the same X/Y coordinates (do not move the cursor) to remove the pixel from the “to be corrected” list. The number of pixels shown to the right of the add icon will decrease to indicate the pixel has been removed.
- Repeat steps 5–9 to add additional defective pixels as needed.
- When all defective pixels have been added to the list, long press the **Menu Button (4)**. A popup window shows “Save changes?” and two options, No and Yes. No is selected by default.
- Short press the **Menu Button (4)** to select **No** to return to the main menu without correcting any defective pixels; **OR**
- Short press the **Up (3) or Down (5) Button** to select **Yes** to correct the saved list of pixels and return to the home screen.

NOTES:

	<p>The PIP window and interface controls move to the upper-left corner when the cursor moves into the lower-left corner.</p>	
<p>Gallery</p> 	<p>View photos and videos saved to the device</p> <ul style="list-style-type: none"> ● Long press the Menu Button to enter the main menu. ● Short press the Up or Down Button to select the gallery  menu item. ● Short press the Menu Button to enter the submenu. ● Short press the Up or Down Button to move through multimedia folders. Folders are named by date in YYYYMMDD format. ● Short press the Menu Button to select a folder, then use the Up and Down Buttons to navigate through the image and video files. A thumbnail of the selected files appears on the right side of the screen. ● Short press the Menu Button to view an image or video file in full screen. When viewing video files, short press the Menu Button to play and pause the video. ● Long press the Menu Button to return to the list of files. ● Short press the Power Button to return to the home screen. 	
<p>Settings Menu</p> 	<p>Adjust the general settings</p> <ul style="list-style-type: none"> ● Long press the Menu Button (4) to enter the main menu. ● Short press the Up (3) or Down (5) Button to select the settings  menu item. ● Short press the Menu Button (4) to enter the settings submenu. 	
	<p>Date</p> 	<p>Set the date</p>

	<ul style="list-style-type: none"> ● In the settings submenu, short press the Up (3) or Down (5) Button to select the date 📅 menu item. ● Short press the Menu Button (4) to edit the date. A blue arrow will appear above and below the year digit. The date is displayed in YYYY.MM.DD format. ● Short press the Up (3) or Down (5) Button to select the correct value for each digit (year, month, and day). ● Short press the Menu Button (4) to switch between digits. The two arrows move to indicate the selected digit. ● Long press the Menu Button (4) to save the date and return to the home screen. 	
<p style="text-align: center;">Time</p> 	<p>Set the time</p> <ul style="list-style-type: none"> ● In the settings submenu, short press the Up (3) or Down (5) Button to select the time 🕒 menu item. ● Short press the Menu Button (4) to edit the time. A blue arrow will appear above and below the hour digit. The time is displayed in HH.MM, in 24-hour format. ● Short press the Up (3) or Down (5) Button to select the correct value for each digit (hour and minute). ● Short press the Menu Button (4) to switch between digits. The two arrows move to indicate the selected digit. 	

	<ul style="list-style-type: none"> ● Long press the Menu Button (4) to save the time and return to the home screen. The set time appears in the status bar.
<p style="text-align: center;">Language</p> 	<p>Set the language</p> <ul style="list-style-type: none"> ● In the settings submenu, short press the Up (3) or Down (5) to select the languages  menu item. ● Short press the Menu Button (4) to enter the submenu. ● Short press the Up (3) or Down (5) to move through the language options. ● Long press the Menu Button (4) to confirm the selection and return to the home screen. 
<p style="text-align: center;">Units of Measure</p> 	<p>Set the units of measurement</p> <ul style="list-style-type: none"> ● In the settings submenu, short press the Up (3) or Down (5) to select the unit  menu item. ● Short press the Menu Button (4) to enter the submenu. ● Short press the Up (3) or Down (5) to move through the options, yards and meters. The selected unit of measure, yd (yards) or m (meters), displays along with the selected zero profile and distance in the status bar. ● Long press the Menu Button (4) to confirm the selection and return to the home screen 

Factory Reset





Restore factory default settings

- In the settings submenu, short press the **Up (3) or Down (5)** to select the factory reset  menu item.
- Short press the **Menu Button (4)** to enter the factory reset submenu.
- Two options, Yes and No, appear; Yes will restore factory settings and No will cancel the operation. No is selected by default.
- Short press the **Menu Button (4)** to select **Yes** to confirm the factory reset. Factory settings will be restored and the SLIM will reboot automatically; **OR**
- Short press the **Up (3) or Down (5)** to select **No** and short press the **Menu Button (4)** to confirm cancellation of the factory reset and return to the submenu

FACTORY RESET NOTES:

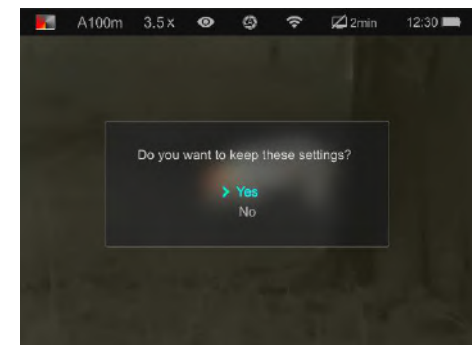
- The screen will go dark and the factory restart will begin after a pause of about 10 seconds.
- A factory reset cannot be undone.
- The settings listed below will be reset to the factory defaults:
 - Color Palette: White Hot
 - Zeroing Profile: A



		<ul style="list-style-type: none"> - Image Brightness: 5 - Image Contrast: 5 - Image Sharpness: 5 - Digital Zoom: 1x - Ultra-Clear mode: Off - Wi-Fi: Off - Interconnection: Off - Auto Calibration: On - Motion Sensor: Off - Reticle Type: 1 - Reticle Color: Black Red - Microphone: Off - Standby: Off - Language: English - Unit: Meters - Wi-Fi Password: 12345678 - Wi-Fi SSID: SLIM_XXXXX_YYYYYYYY
	<p>Info</p> 	<p>View the device information</p> <ul style="list-style-type: none"> ● In the settings submenu, short press the Up (3) or Down (5) to select the info  menu item. ● Short press the Menu Button (4) to enter the submenu. ● The info submenu will display the following information about the SLIM: the model number, the GUI, SYS, and boot versions, and the part and serial numbers. ● Long press the Menu Button (4) to save and return to the home screen.



19 Using the NOCPIX APP

The SLIM can be operated using the NOCPIX App when connected to a smartphone via Wi-Fi.

1. Search and download the App from the app store for free and install it on your device.
2. Connect the SLIM to Wi-Fi:
 - a. Turn on the Wi-Fi on the SLIM.
 - b. Open the App and press the Connect the Device button on the home screen. Then, click the Connect Phone WLAN button.
 - c. On the mobile device, go to Settings-Wi-Fi.
 - d. Select the SLIM from the list of Wi-Fi networks. It will appear in the list as "SLIM_XXXXX_YYYYYYYY," where YYYYYYYY is the eight-digit device serial number.
 - e. Enter the Wi-Fi password and tap the Join button. The default password is 12345678.
3. Operate the SLIM via the App:
 - a. Take real-time photos and videos, with or without audio.

- b. View, share, download, and delete photos and videos taken via the App, which are saved to the mobile device.
- c. Change the Wi-Fi password and SSID.
- d. Synchronize the date and time from the mobile device.
- e. Update the SLIM firmware.

NOTE: When a factory reset is performed, the Wi-Fi SSID and password are reset to the defaults, SLIM_XXXXX_YYYYYYYY and 12345678.

20 Technical Inspection

It is recommended to carry out a technical inspection before each use.

Please check the following:

- The rifle scope appearance: there should be no cracks in the body or visible damage.
- The condition of the objective lens and eyepiece: there should be no cracks, greasy spots, dirt, or other deposits on the lens.
- The rechargeable battery should be fully charged.

- The control buttons should be in working order.

21 Maintenance

Always replace the objective lens cap (1) after use to avoid damaging or scratching the lens. Never touch the lens directly; oil from your skin can damage the lens coating and surface.

Basic maintenance should be carried out at least twice a year and includes the following steps:

- Wipe the surface of the external metal and plastic components with a clean, dry cotton cloth. Do not use chemical, corrosive, or abrasive cleaners. Canned air may also be used to clean the external components.
- Clean the electric contacts and battery slots on the rifle scope

using a non-greasy organic solvent.

- Check the lens and eyepiece. If necessary, remove any dirt or sand from the optics; a non-contact cleaning method is preferred.
- Cleaning the exterior of the lens should only be done with the included microfiber lens cloth or a similar product. Only clean the lens when it is visibly soiled. Frequent wiping or cleaning can degrade the anti-reflective lens coating.

22 Troubleshooting

The following table lists all problems that are likely to occur during device operation. Check and address problems by referring to this table. If faults not included in this table occur or you cannot fix the fault, return the device to its vendor or supplier for troubleshooting.

Issue	Possible Causes	Troubleshooting Steps
The SLIM will not turn on.	The 18650 battery is very low or has completely discharged.	Charge the battery.
The SLIM cannot connect to a computer or external power supply.	External power supply has completely discharged.	Check the external power supply and charge it if necessary.

	Computer is turned off.	Power on the computer.
	USB-C or magnetic charging cable is damaged.	Replace the cable.
The SLIM cannot connect to the mobile device (smartphone or tablet).	Wi-Fi is not turned on.	Turn on the Wi-Fi in the main menu.
	Wrong Wi-Fi password entered.	On the mobile device, go to Settings > Wi-Fi and enter the correct password. The default password is 12345678.
	Too many Wi-Fi signals nearby, which may cause interference.	Move the SLIM and mobile device to an area with no or fewer Wi-Fi signals.
Wi-Fi signal is lost or interrupted.	The device is out of range of a strong Wi-Fi signal, or there are obstacles (such as concrete walls) between the device and the signal.	<ul style="list-style-type: none"> • Try again when the Wi-Fi signal is stable. • Move the SLIM closer to the Wi-Fi signal.
The image is blurry, the background is uneven, or vertical lines or artifacts are present.	Non-uniformity correction is required.	Perform a non-uniformity correction.
The image is too dark.	The image is too dark.	Adjust the image brightness in the quick menu.
The GUI is clear, but the image is blurry.	The lens is not focused.	<ul style="list-style-type: none"> • Adjust the focus on the target by rotating the objective focus knob (2). • Adjust the image sharpness in the quick menu.

	There is dust or ice on the interior or exterior optical surfaces of the lens	Wipe the external optical surface with the included microfiber lens cloth.
	There is condensation on the interior or exterior optical surfaces of the lens	<ul style="list-style-type: none"> • Wipe the external optical surface with the included microfiber lens cloth. • Allow the SLIM to dry by leaving it in a warm, dry environment for at least 4 hours.
The aiming reticle shifts after firing rounds.	The SLIM is not mounted securely or the mount is not secured on the SLIM.	<ul style="list-style-type: none"> • Check that the SLIM has been securely mounted. • Make sure you are using the same brand, type, and weight of the bullets as when the SLIM and weapon were initially zeroed. • If the SLIM was zeroed in different environmental conditions, a slight shift of the zero is possible.
Observed target disappears.	Observing the target through glass.	Remove any glass windows from the field of view.
The SLIM will not focus.	Image settings are not optimal for the current environmental conditions or the object being observed.	<ul style="list-style-type: none"> • Check the external surface of the objective lens and eyepiece and, where necessary, wipe away any dust, condensation, frost, etc. • In cold weather, you can use special anti-fogging coatings, such as those made for corrective glasses. • Adjust the focus on the target by rotating the objective

		<p>focus knob (2).</p> <ul style="list-style-type: none"> • Adjust the image sharpness in the quick menu. • Adjust the image and device settings. • Turn on Ultra-Clear mode.
<p>Image quality is low or the detection range is reduced.</p>	<p>Environmental conditions, such as snow, rain, humidity, and fog.</p>	<p>Turn on Ultra-Clear mode.</p>
<p>When the SLIM is used in low-temperature conditions, the image quality of the surroundings is worse than in warm-temperature conditions.</p>	<p>Environmental conditions.</p>	<p>In warm-temperature conditions, objects being observed (surroundings and background) heat up differently because of thermal conductivity, thereby generating a high-temperature contrast. Accordingly, image quality produced by the rifle scope will be higher. In low-temperature conditions, the background will cool down to roughly the same temperature, and thus the temperature contrast is substantially reduced and image detail can go down as there is less contrast in the scene. This is a normal function of a thermal imager and is no indicator of actual detector performance.</p>

23 Legal and Regulatory Information

Wireless transmitter module frequency range:

WLAN: 2.412-2.472 GHz

Wireless transmitter module power < 20 dBm



We, Inlumen Technology Co., Ltd. hereby declares that the radio equipment types SLiM series is in compliance with the Directives 2014/53/EU and 2011/65/EU

FCC Statement

FCC ID: 2BHFB-SLiM-00

Labeling requirements

This device complies with part 15 of the FCC Rules. Operation is subject to the following two conditions: (1) This device may not cause harmful interference, and (2) this device must accept any interference received, including interference that may cause undesired operation.

Information to the user

Any Changes or modifications not expressly approved by the party responsible for compliance could void the user's authority to operate the equipment.

EMC: Class A

Note: This equipment has been tested and found to comply with the limits for a Class A digital device, pursuant to part 15 of the FCC Rules. These limits are designed to provide reasonable protection against harmful interference when the equipment is operated in a commercial environment. This equipment generates, uses, and can radiate radio frequency energy and, if not installed and used in accordance with the instruction manual, may cause harmful interference to radio communications. Operation of this equipment in a residential area is likely to cause harmful interference in which case the user will be required to correct the interference at his own expense.

To comply with RF exposure requirements, a minimum separation distance of 0.00 cm must be maintained between the user's body and the handset, including the antenna.



 **Manufacturer:** Inlumen Technology Co., Ltd.

 **Email:** service@nocpix.com

 **Website:** www.nocpix.com

 **Address:** North 16F, Building B3, Hefei Software Park, No. 800 Wangjiang West Road, Hefei National High-tech Industry Development District, Anhui, China